



US00D718781S

(12) **United States Design Patent**
Arnold et al.

(10) **Patent No.:** **US D718,781 S**
(45) **Date of Patent:** **** Dec. 2, 2014**

(54) **DISPLAY SCREEN WITH ANIMATED GRAPHICAL USER INTERFACE**

D682,872 S * 5/2013 Frijlink D14/487
D682,875 S * 5/2013 Frijlink et al. D14/488
D691,623 S * 10/2013 Aroner et al. D14/486

(71) Applicant: **Microsoft Corporation**, Redmond, WA (US)

(Continued)

(72) Inventors: **Jeffery G. Arnold**, Sammamish, WA (US); **Sarah Siritaratiwat**, Seattle, WA (US)

Primary Examiner — Melanie H Tung

(74) *Attorney, Agent, or Firm* — Banner & Witcoff, Ltd.

(73) Assignee: **Microsoft Corporation**, Redmond, WA (US)

(57) **CLAIM**

The ornamental design for a display screen with animated graphical user interface, as shown and described.

(**) Term: **14 Years**

DESCRIPTION

(21) Appl. No.: **29/449,016**

FIG. 1 is the first image in a sequence for a display screen with animated graphical user interface showing a new design; FIG. 2 is the second image thereof; FIG. 3 is the third image thereof; FIG. 4 is the fourth image thereof; FIG. 5 is the fifth image thereof; FIG. 6 is the sixth image thereof; FIG. 7 is the seventh image thereof; FIG. 8 is the eighth image thereof; FIG. 9 is the ninth image thereof; FIG. 10 is the tenth image thereof; FIG. 11 is the eleventh image thereof; FIG. 12 is the twelfth image thereof; FIG. 13 is the thirteenth image thereof; FIG. 14 is the fourteenth image thereof; FIG. 15 is the fifteenth image thereof; FIG. 16 is the sixteenth image thereof; and, FIGS. 17-32 show the display screen with animated graphical user interface of FIGS. 1-16 on a device.

(22) Filed: **Mar. 14, 2013**

(51) **LOC (10) Cl.** **14-04**

(52) **U.S. Cl.**
USPC **D14/486**; D14/488

(58) **Field of Classification Search**
CPC G06F 3/048-3/04897
USPC D14/485-95; D18/24-33; D19/6, 52; D20/11; D21/324-33; 715/700-867, 715/973-77

See application file for complete search history.

The appearance of the animated graphical user interface sequentially transitions between the images shown in FIGS. 1-16 and in FIGS. 17-32. The process or period in which one image transitions to another forms no part of the claimed design. The broken line showing of the device having the display screen in FIGS. 17-32 is for environmental purposes only and forms no part of the claimed design.

(56) **References Cited**

U.S. PATENT DOCUMENTS

D613,300 S *	4/2010	Chaudhri	D14/488
D624,932 S *	10/2010	Chaudhri	D14/488
D637,604 S *	5/2011	Brinda	D14/488
D648,347 S *	11/2011	Chaudhri	D14/488
D650,791 S *	12/2011	Weir et al.	D14/488
D651,609 S *	1/2012	Pearson et al.	D14/486
D664,552 S *	7/2012	Gleasant et al.	D14/486
D675,223 S *	1/2013	Woo et al.	D14/487
D675,638 S *	2/2013	Woo et al.	D14/487
D679,730 S *	4/2013	Tyler et al.	D14/492
D681,052 S *	4/2013	Woo	D14/492
D682,869 S *	5/2013	Aroner et al.	D14/487

1 Claim, 32 Drawing Sheets

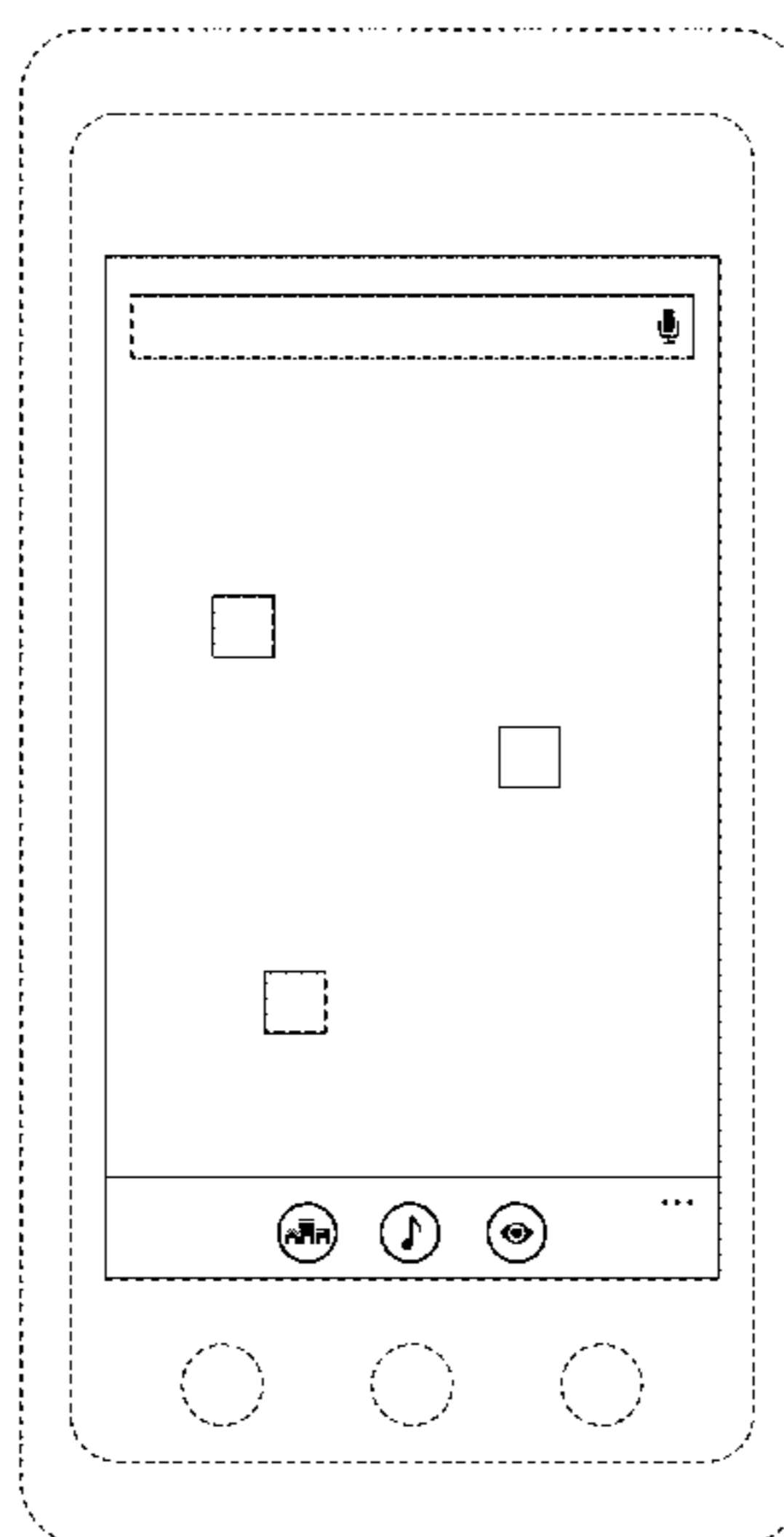
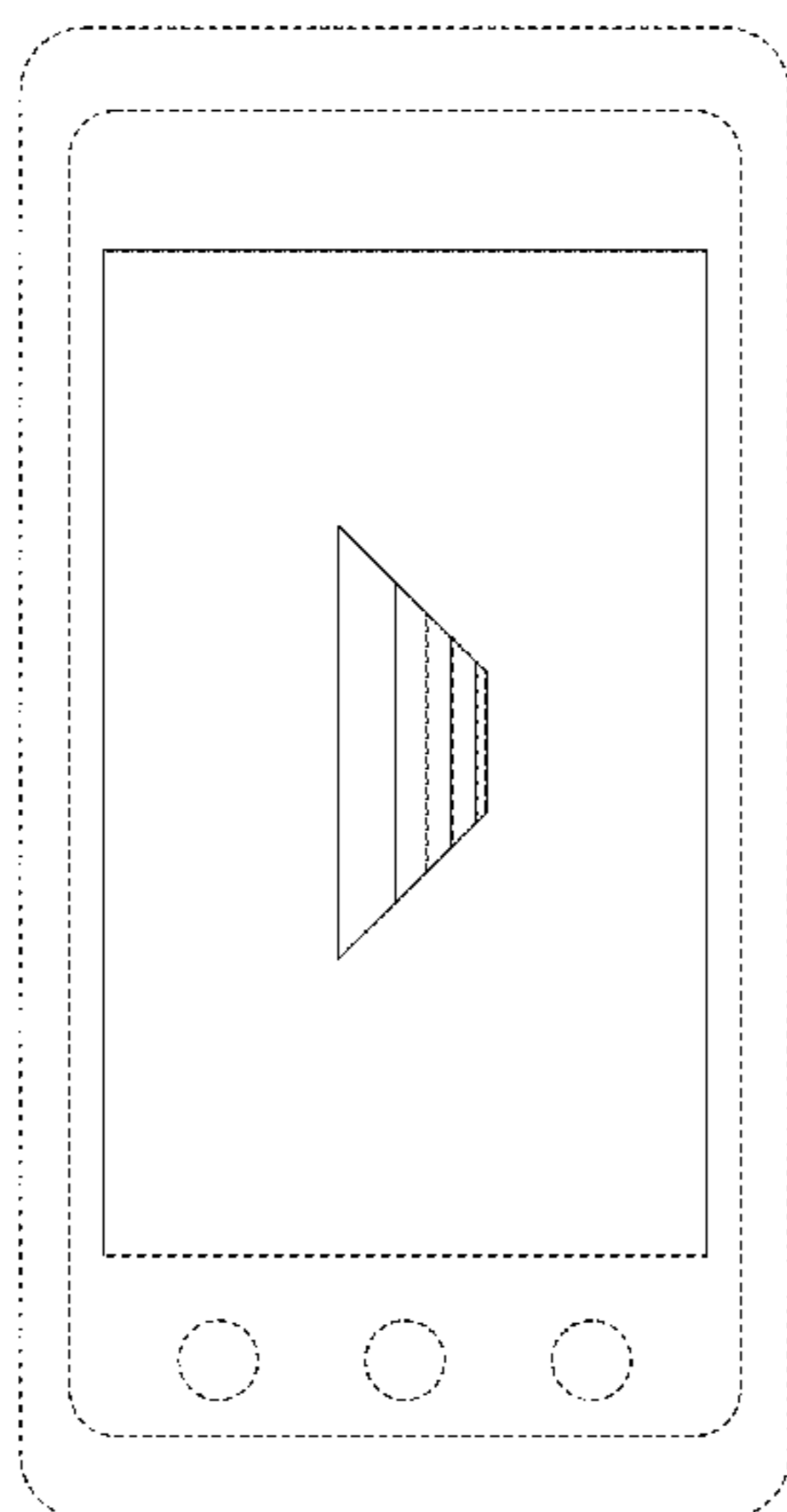

(56)

References Cited

U.S. PATENT DOCUMENTS

D693,356 S * 11/2013 Rodenhouse et al. D14/486
D695,755 S * 12/2013 Hwang et al. D14/485
D697,079 S * 1/2014 Yuk et al. D14/488
D701,527 S * 3/2014 Brinda et al. D14/488

D705,244 S * 5/2014 Arnold et al. D14/486
D711,405 S * 8/2014 Hurd et al. D14/486
D711,406 S * 8/2014 Hurd et al. D14/486
D711,902 S * 8/2014 Scott D14/486
D712,419 S * 9/2014 Song et al. D14/486

* cited by examiner

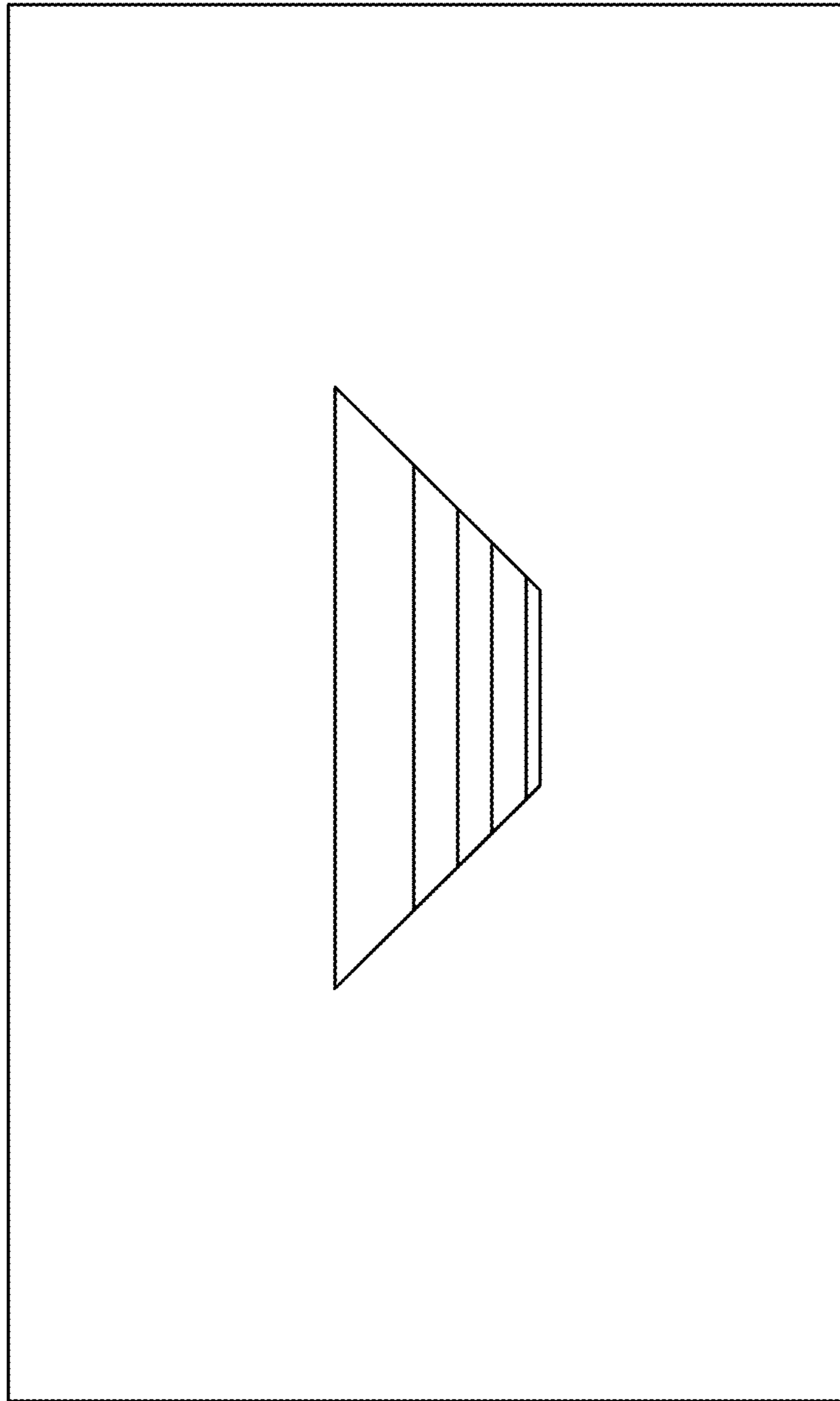

FIG. 1

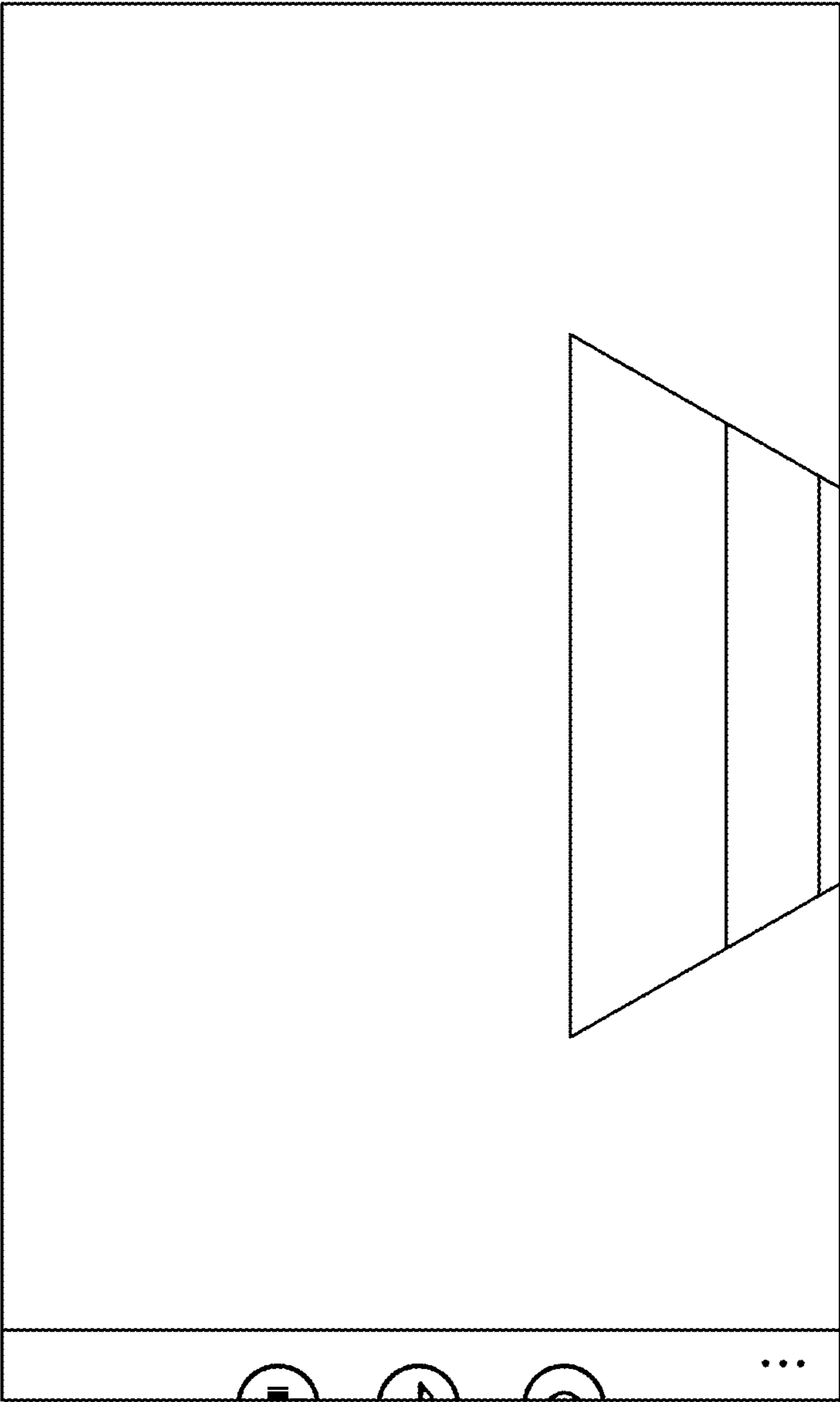

FIG. 2

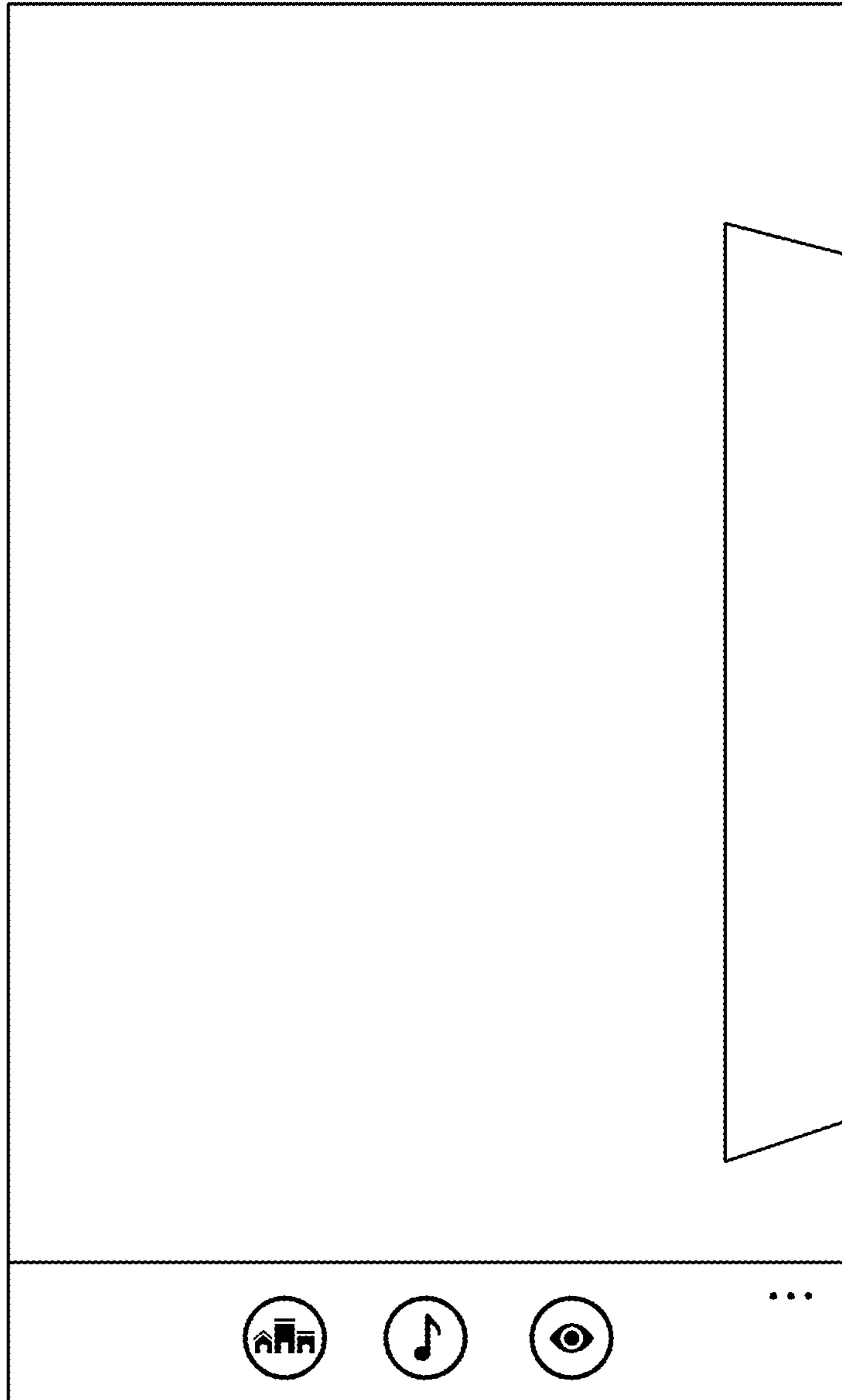

FIG. 3

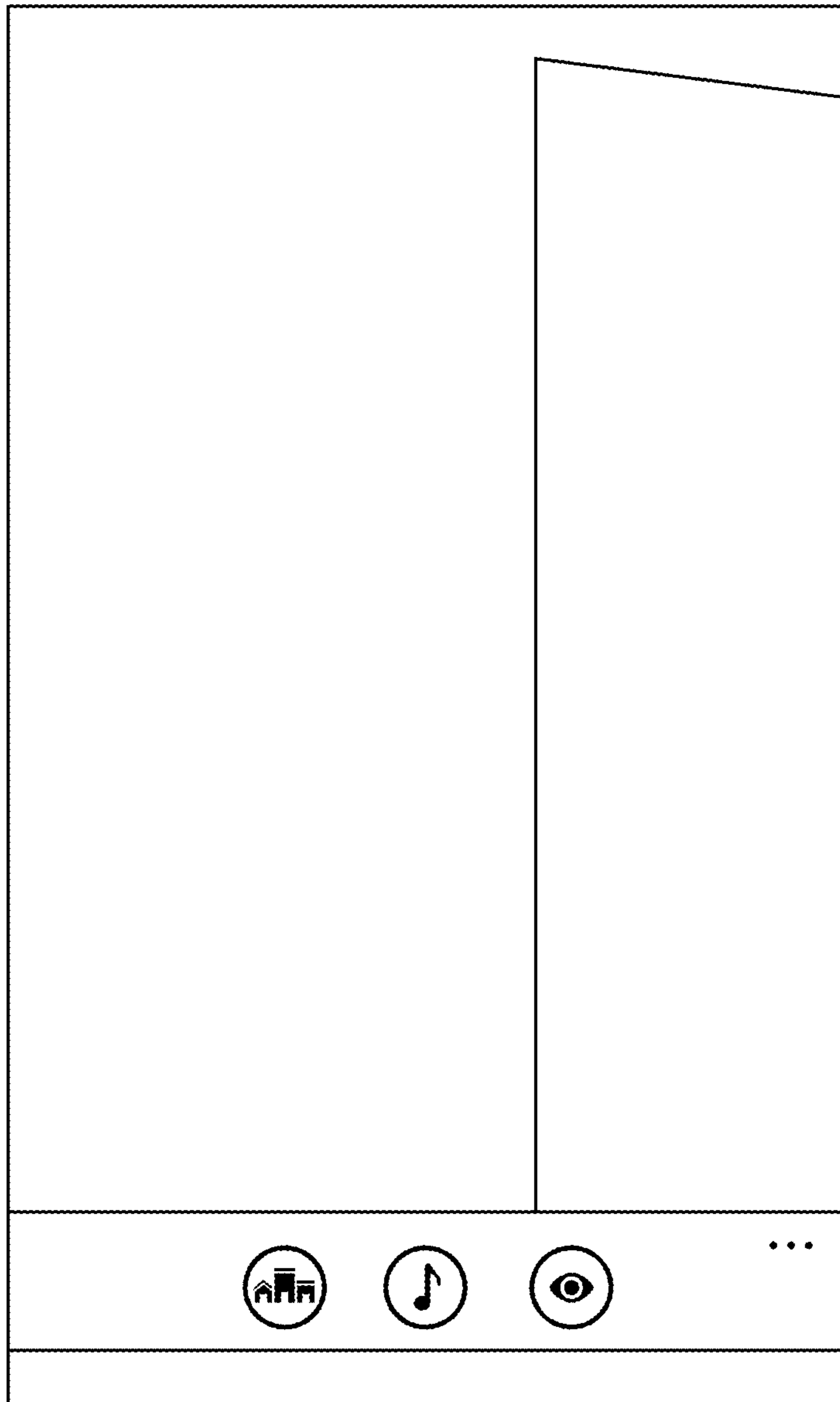

FIG. 4

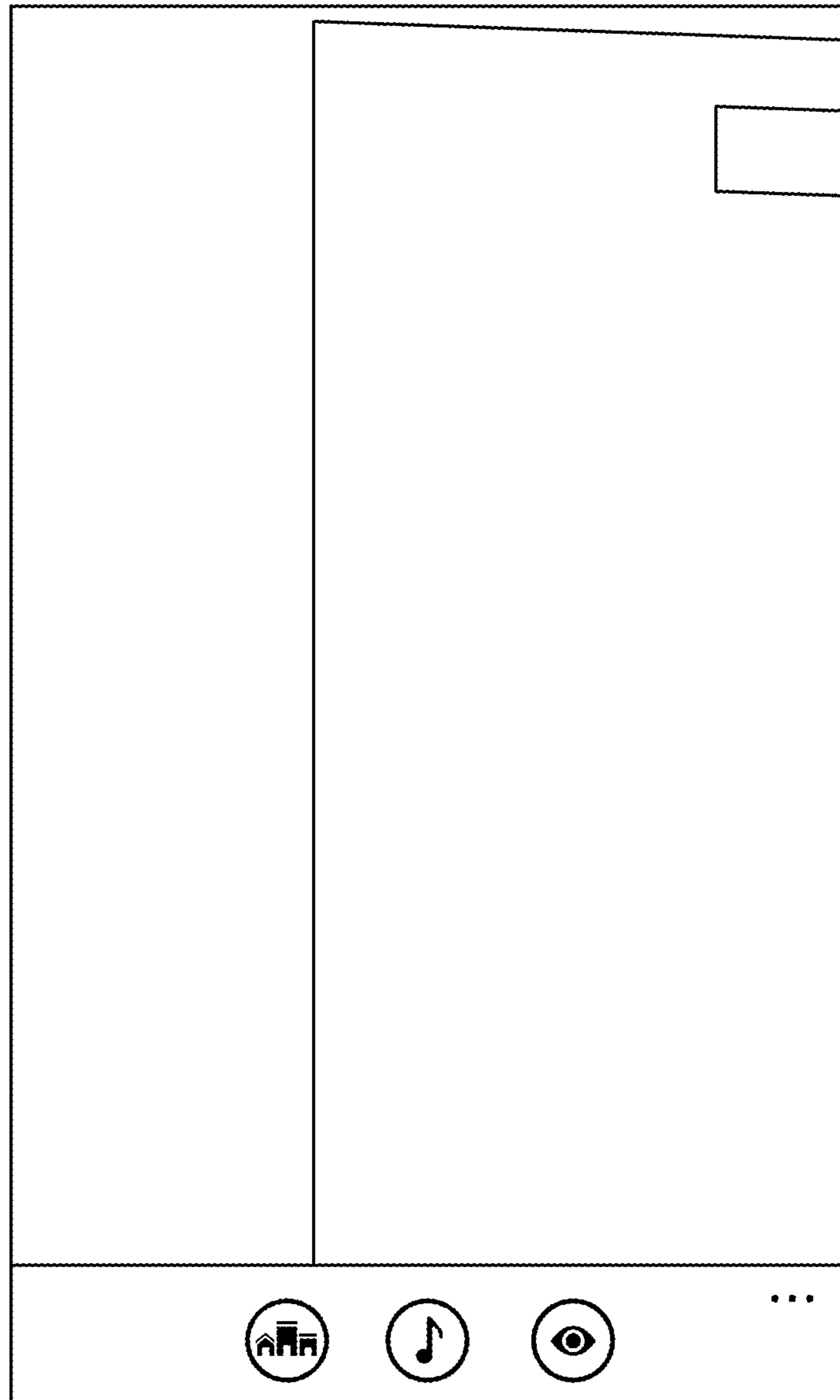

FIG. 5

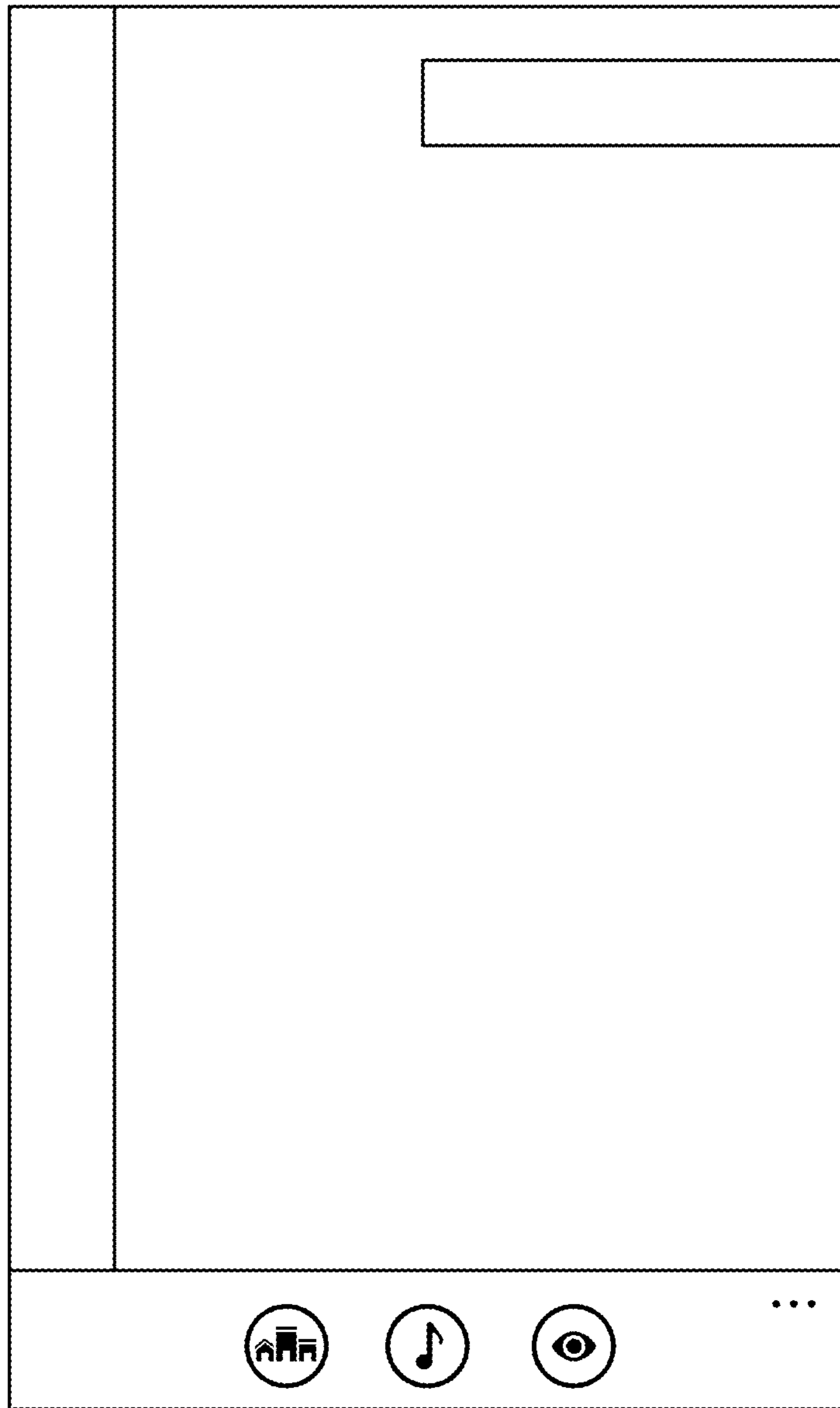

FIG. 6

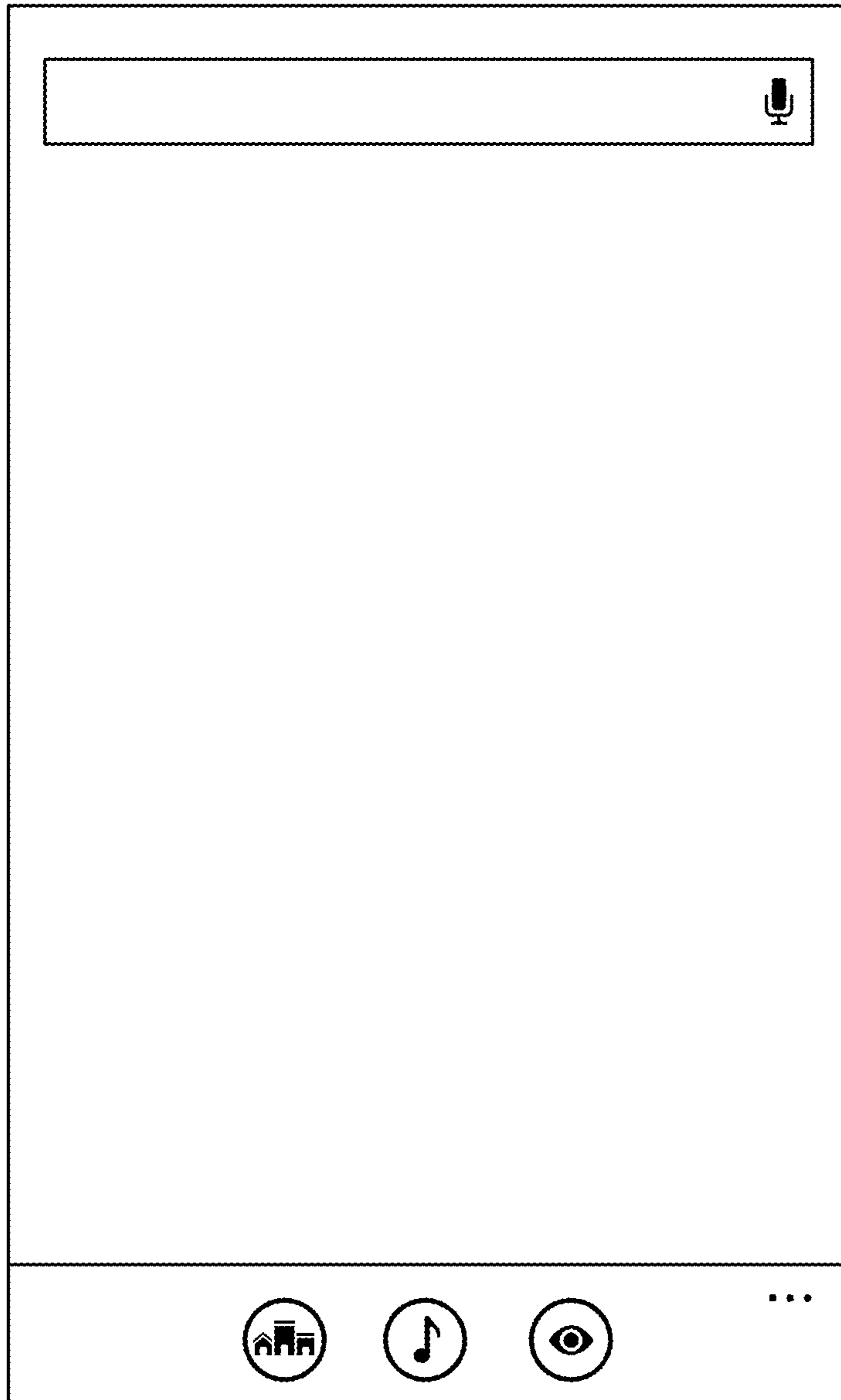

FIG. 7

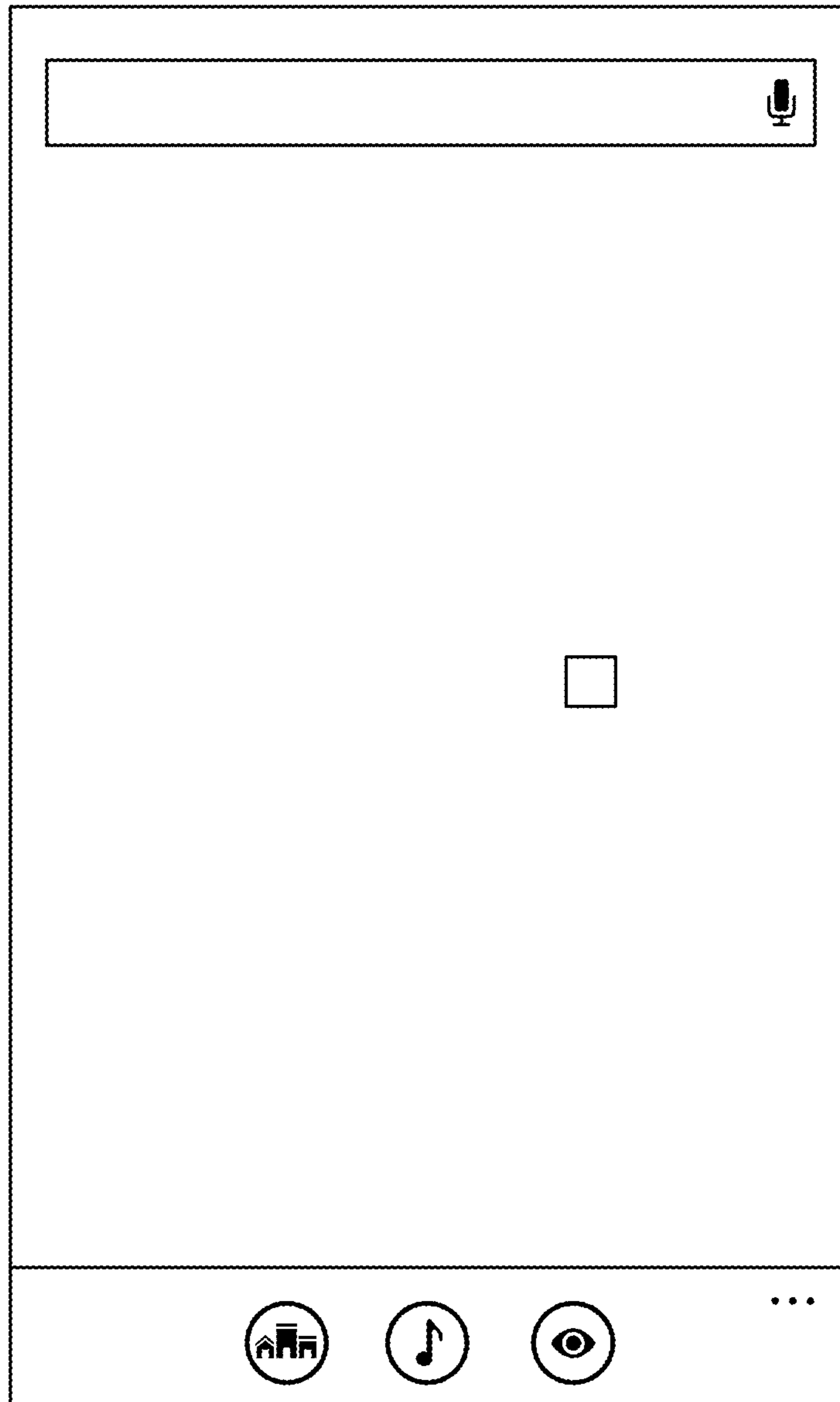

FIG. 8

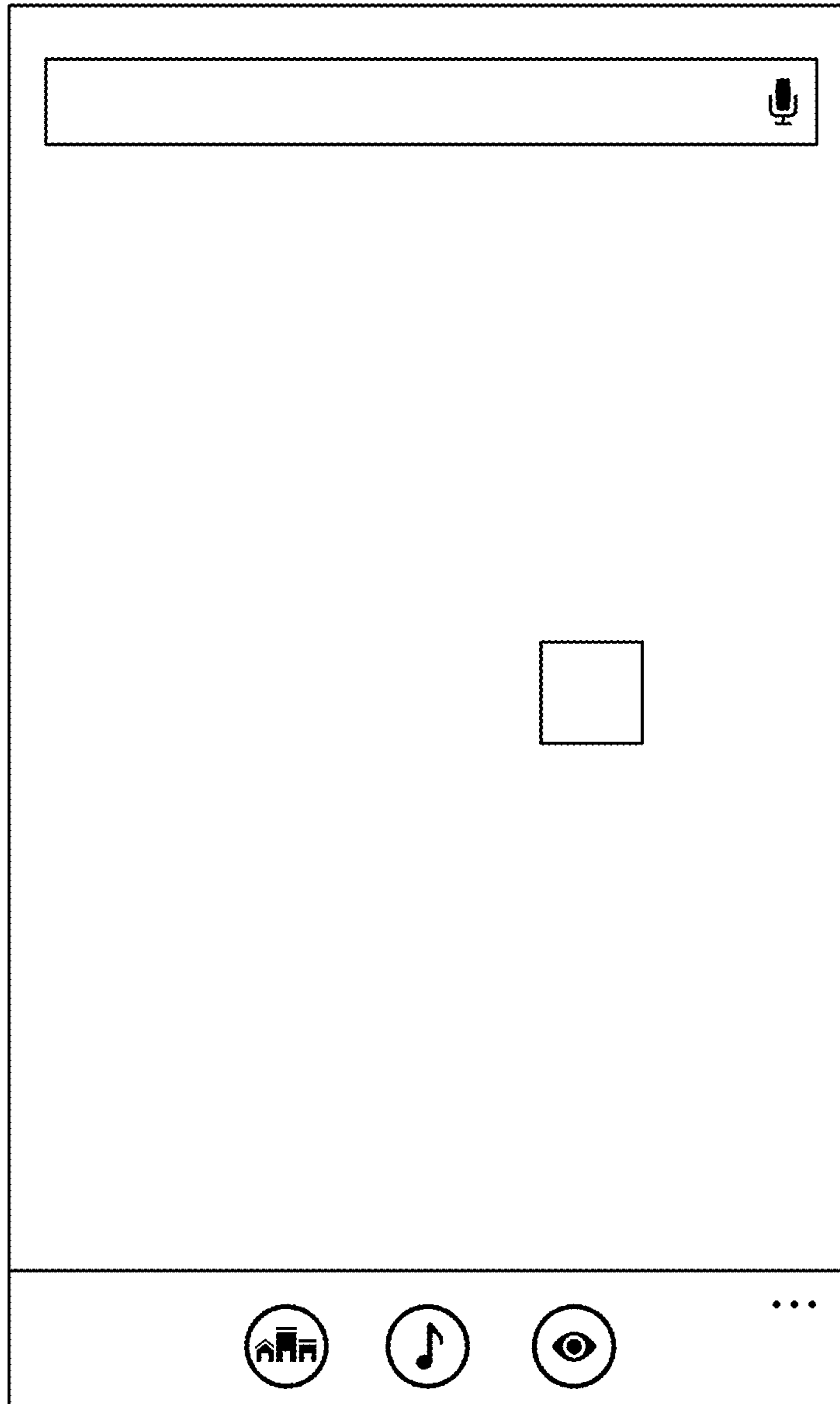

FIG. 9

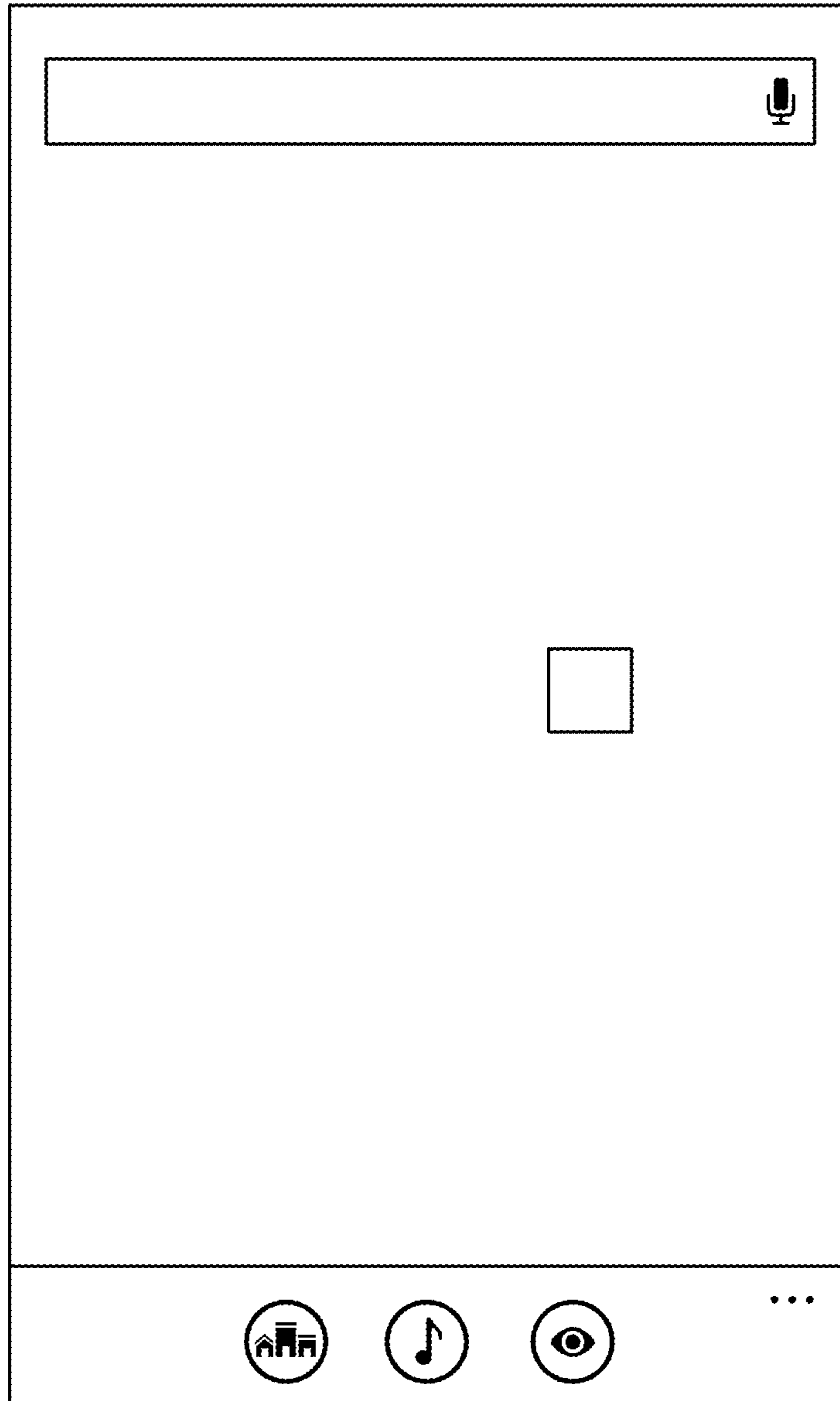

FIG. 10

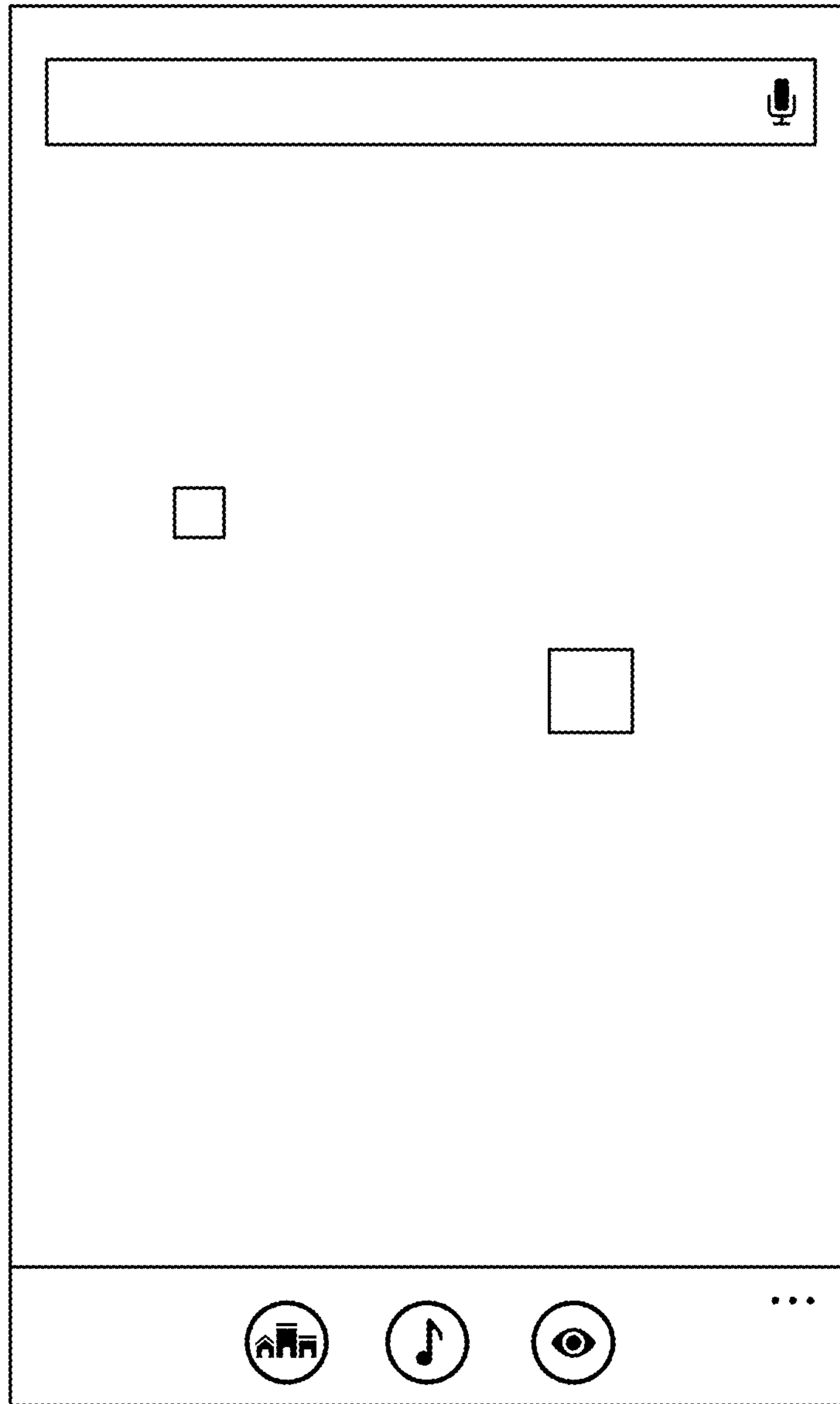

FIG. 11

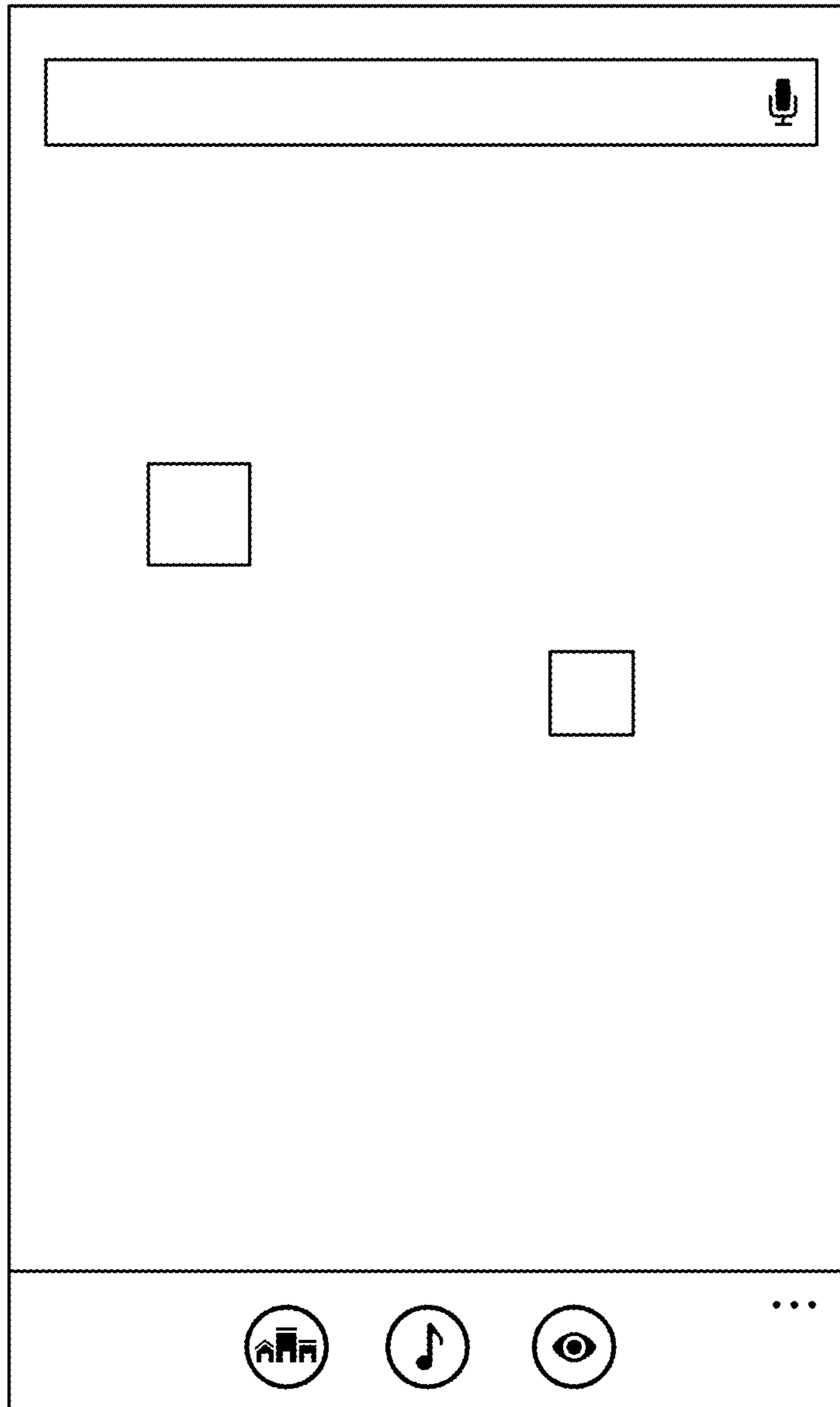

FIG. 12

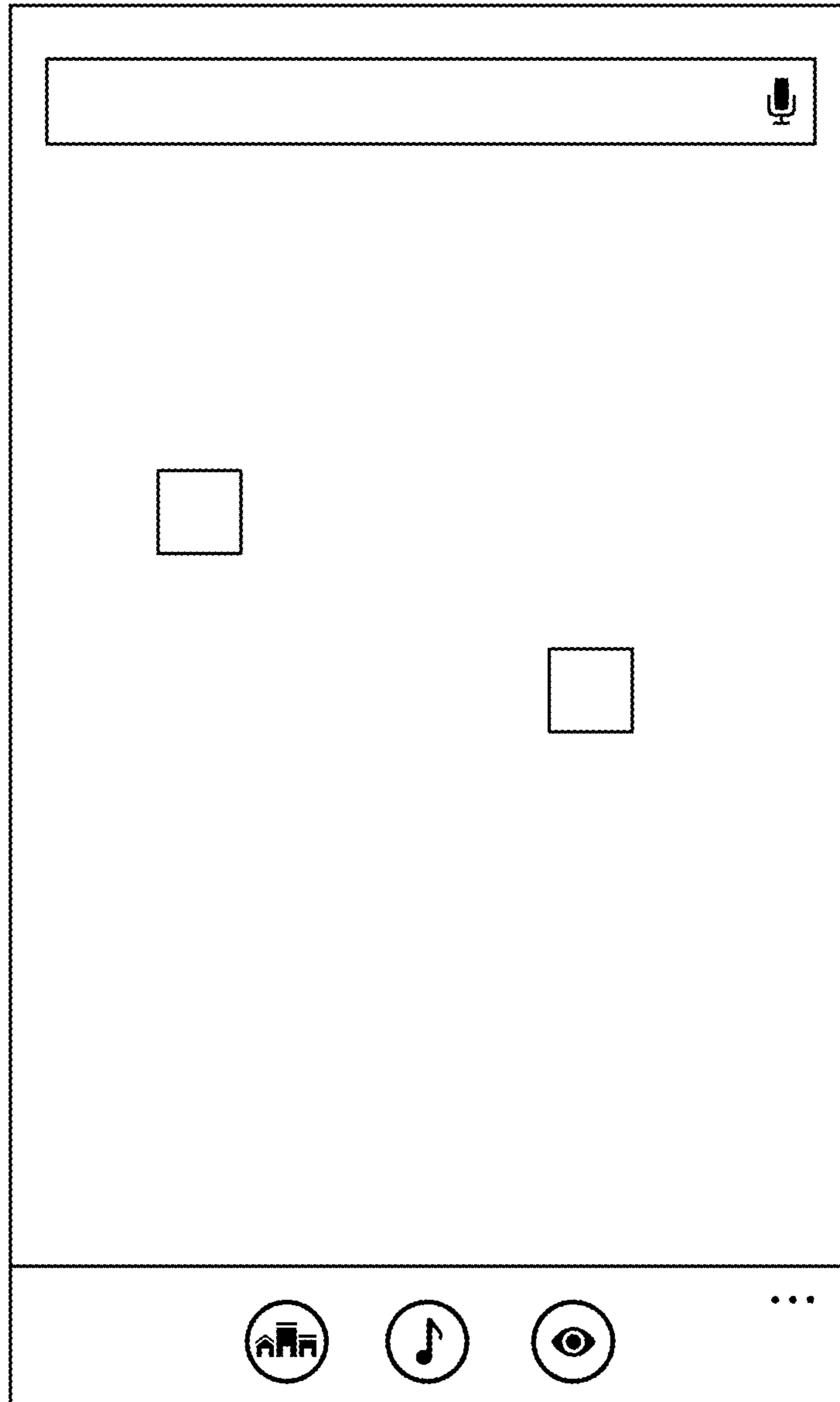

FIG. 13

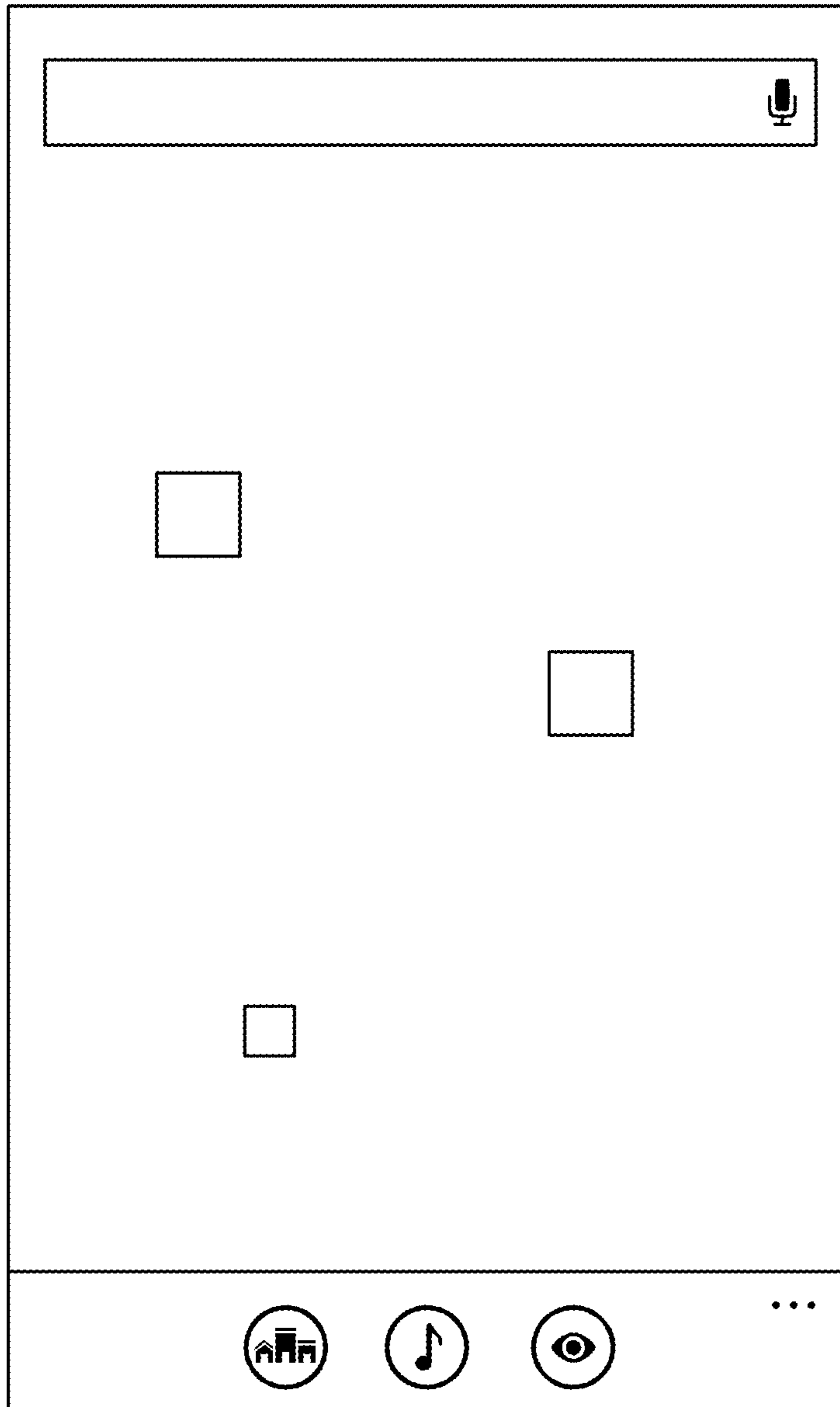

FIG. 14

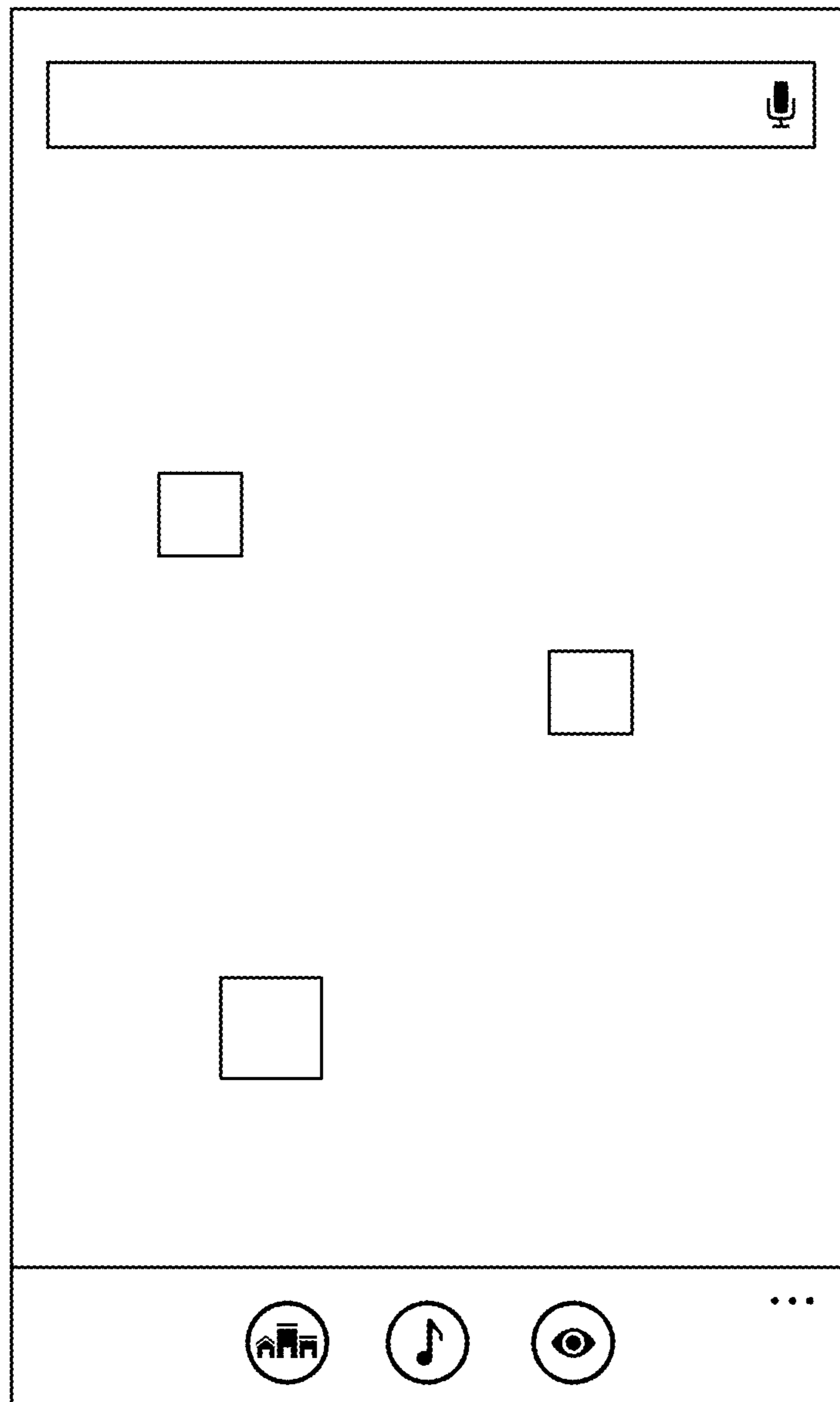

FIG. 15

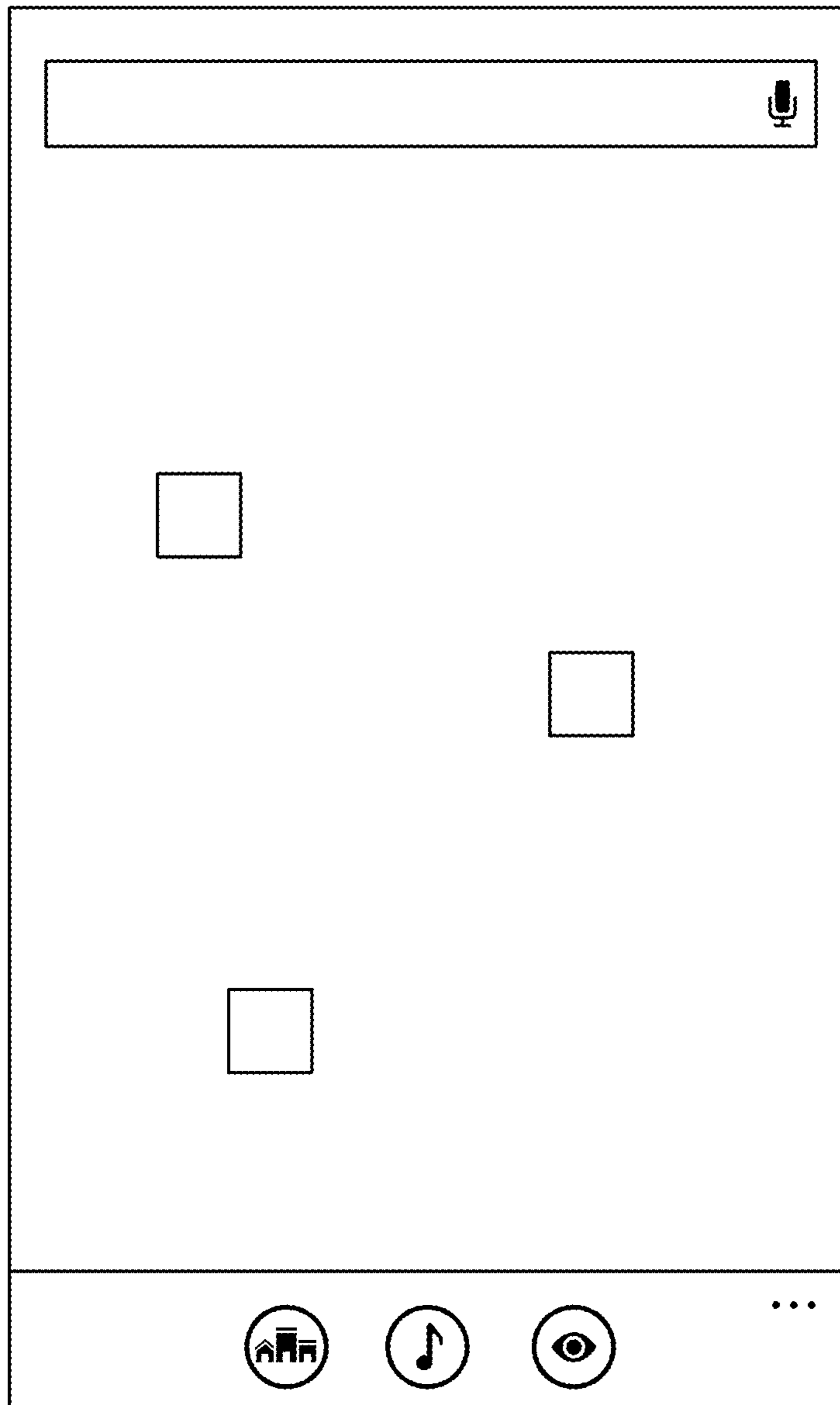

FIG. 16

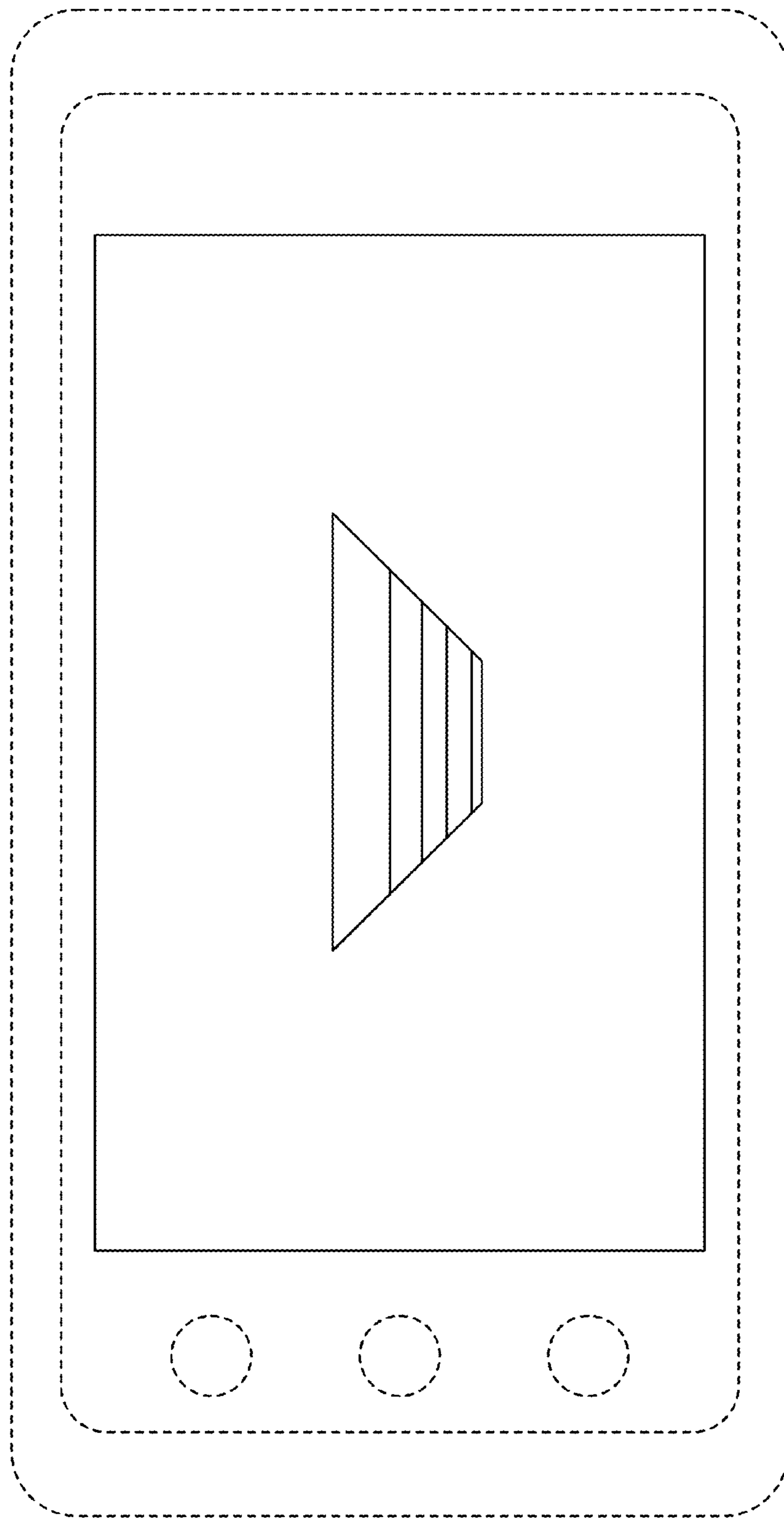

FIG. 17

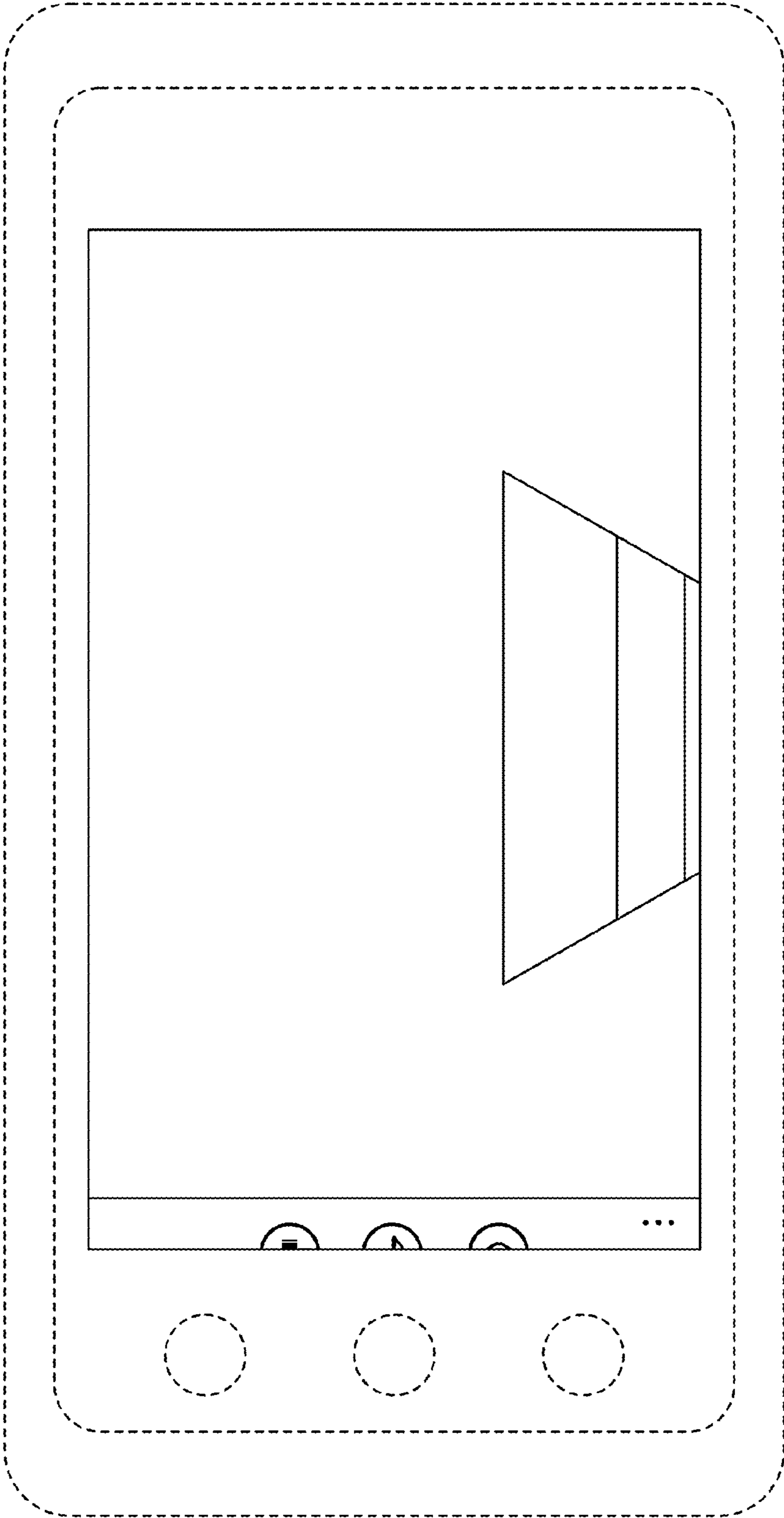

FIG. 18

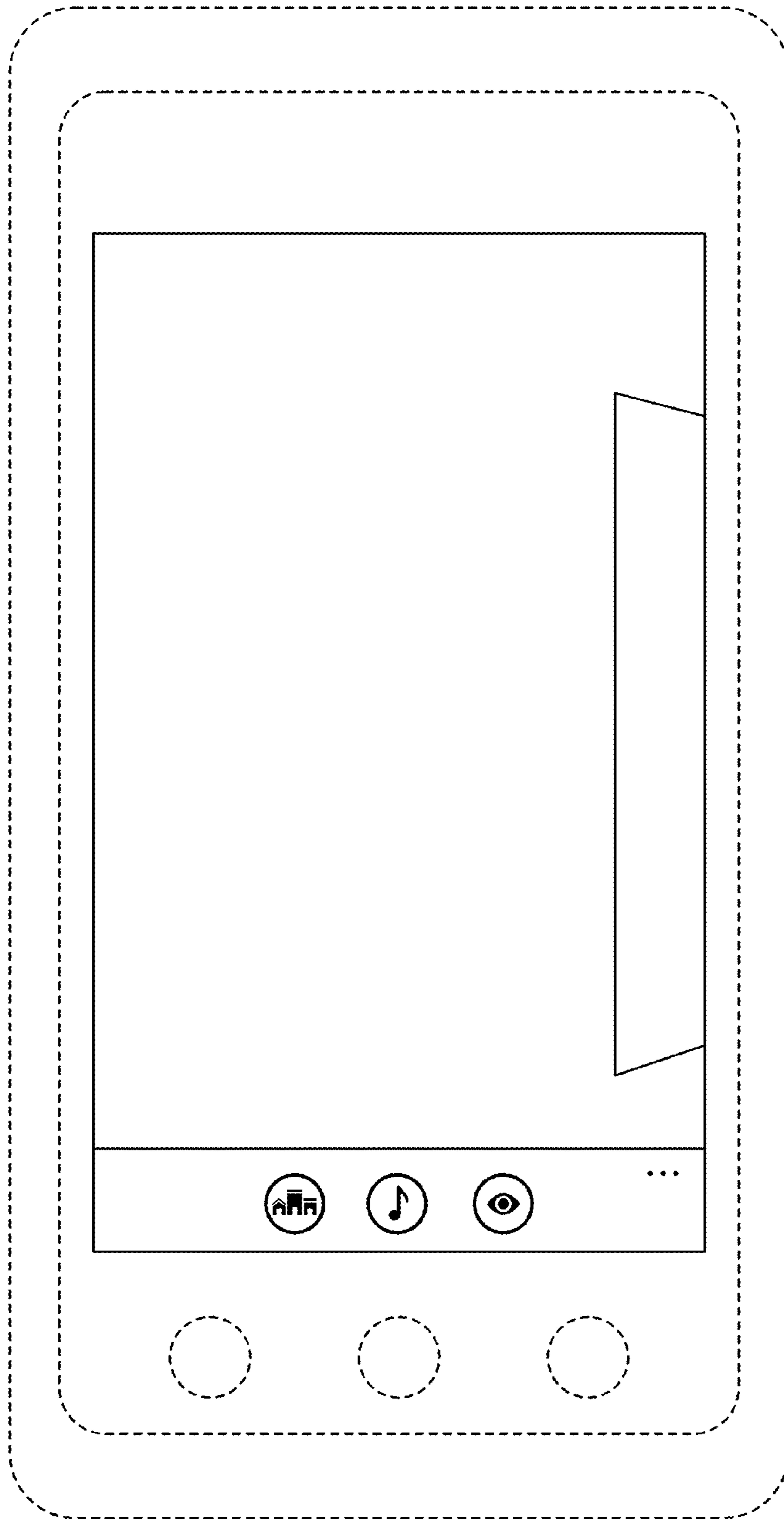

FIG. 19

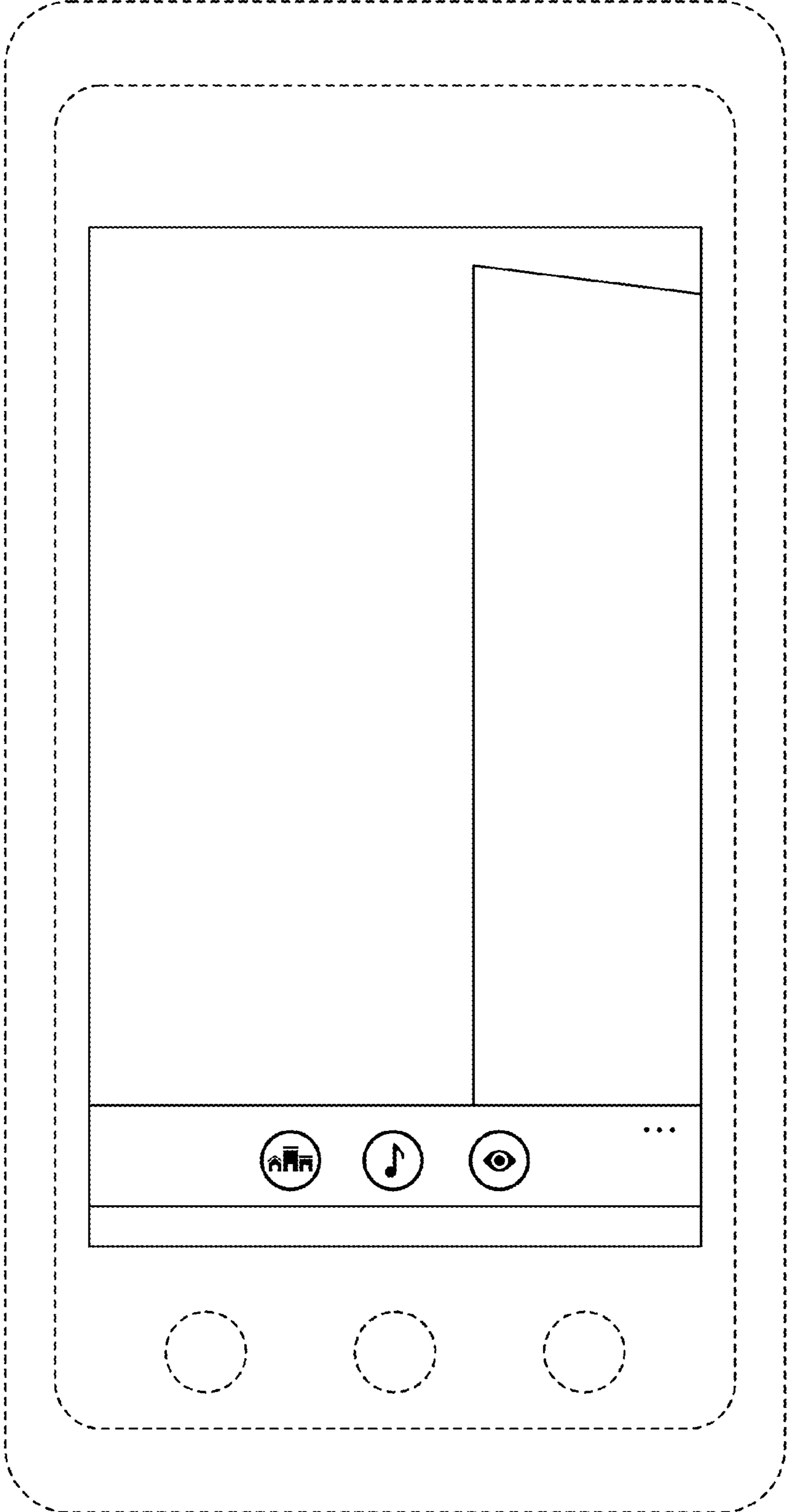

FIG. 20

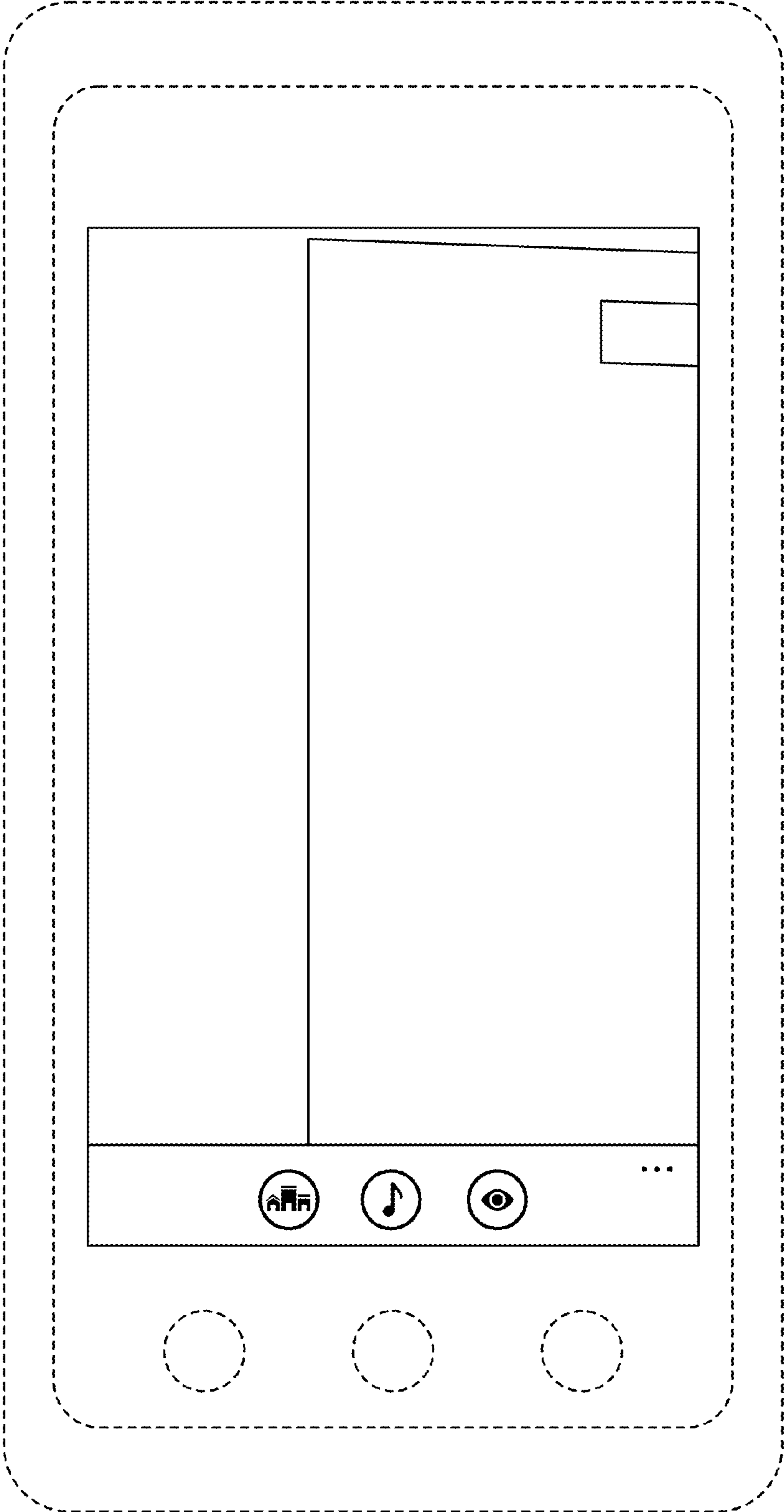

FIG. 21

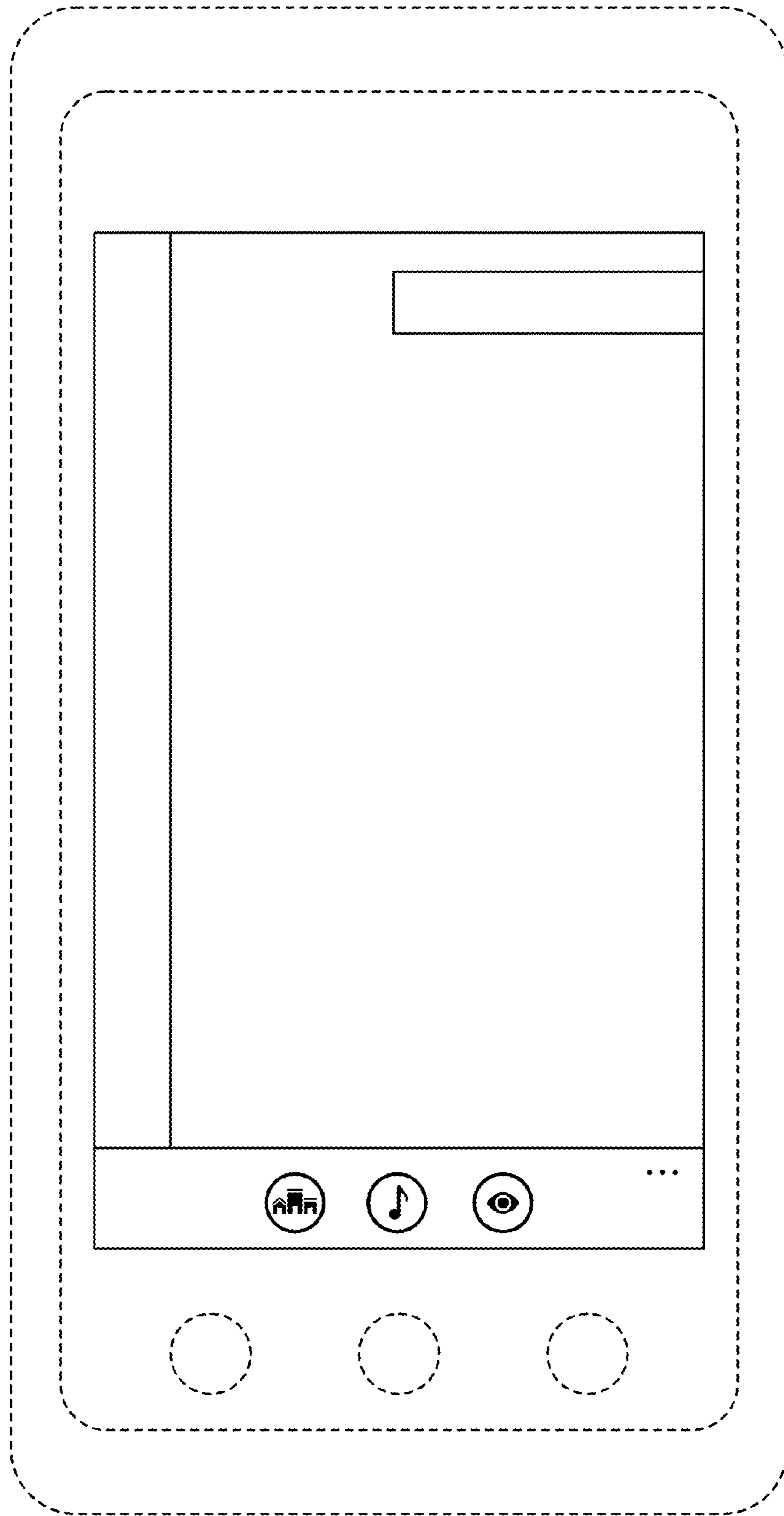

FIG. 22

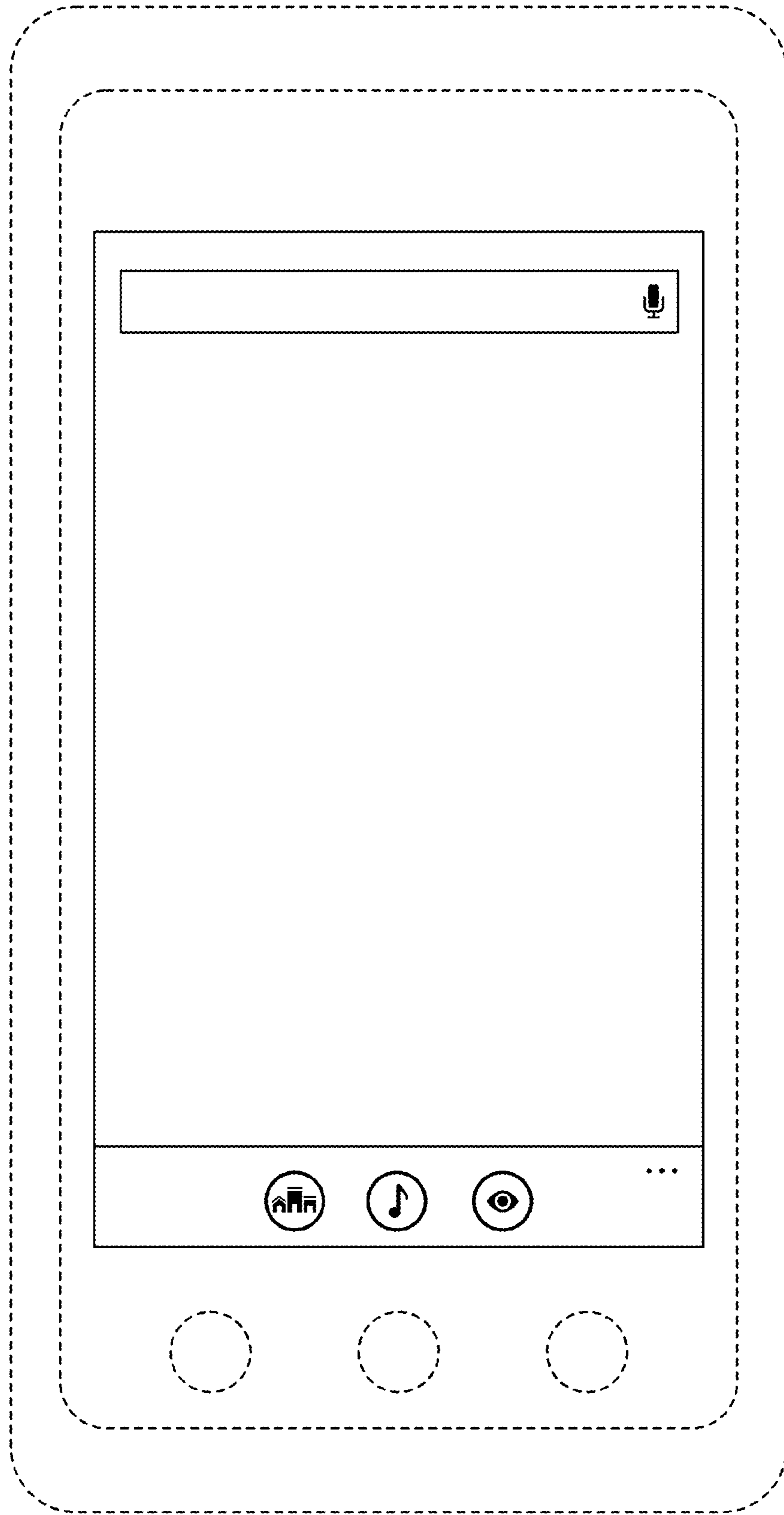

FIG. 23

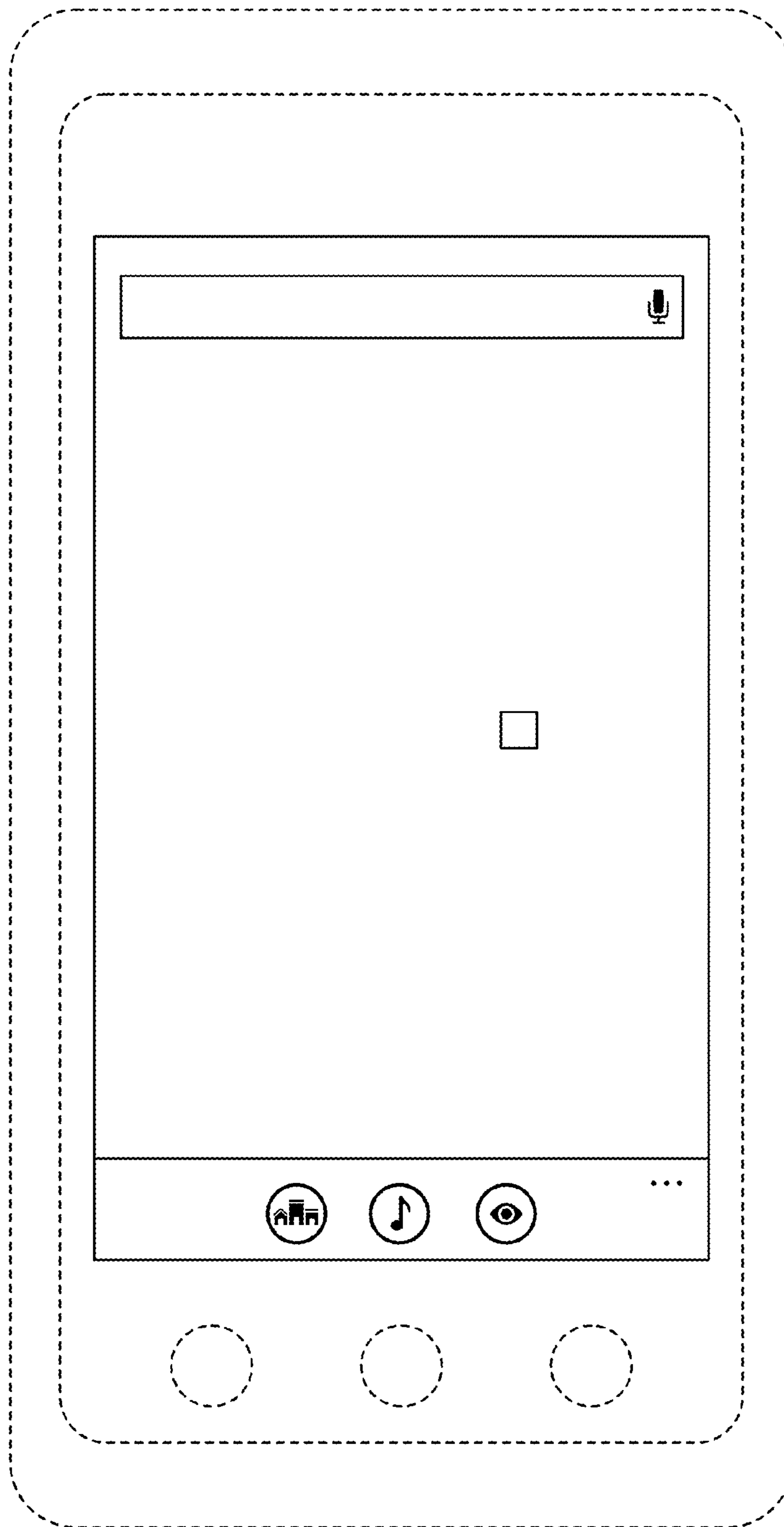

FIG. 24

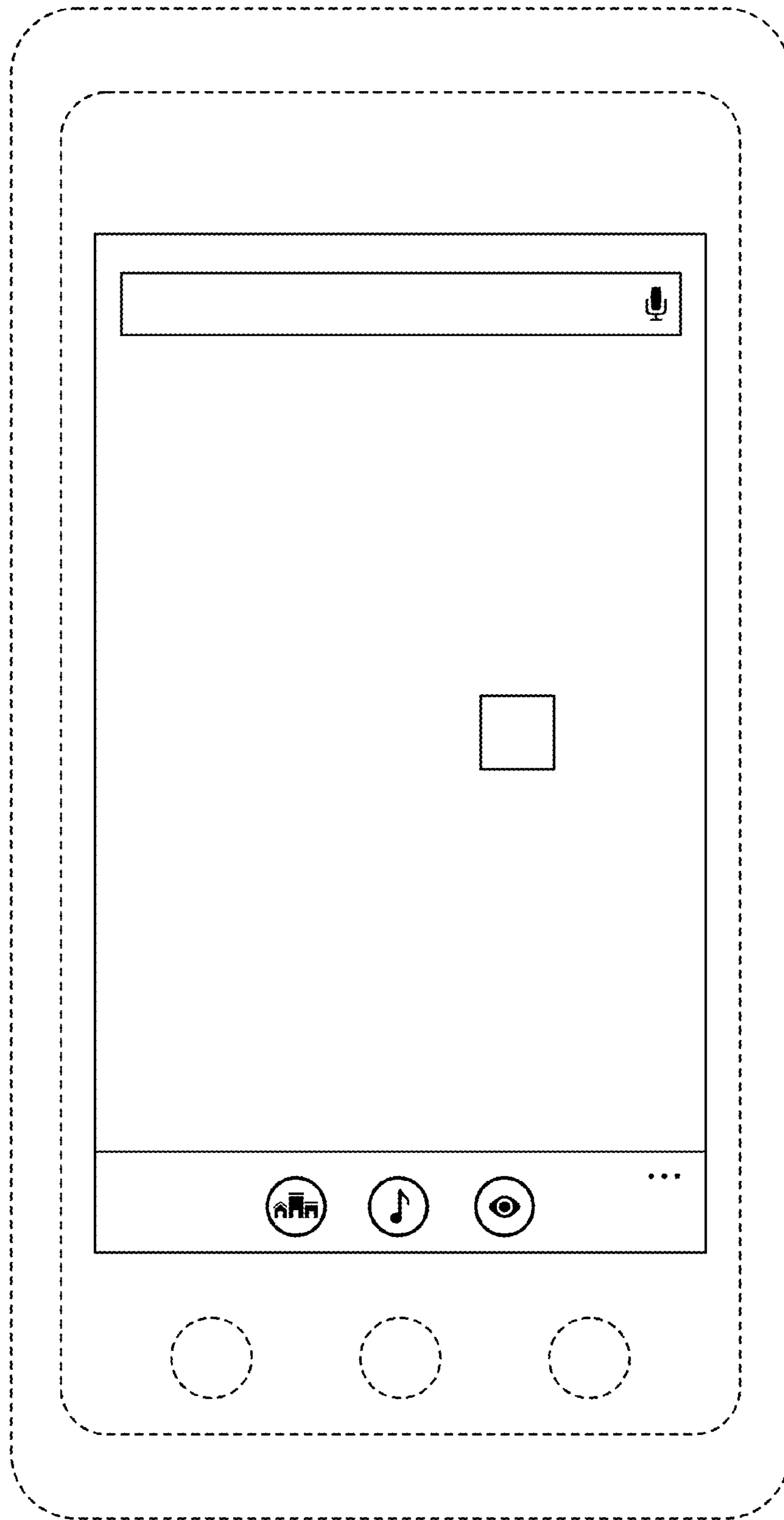

FIG. 25

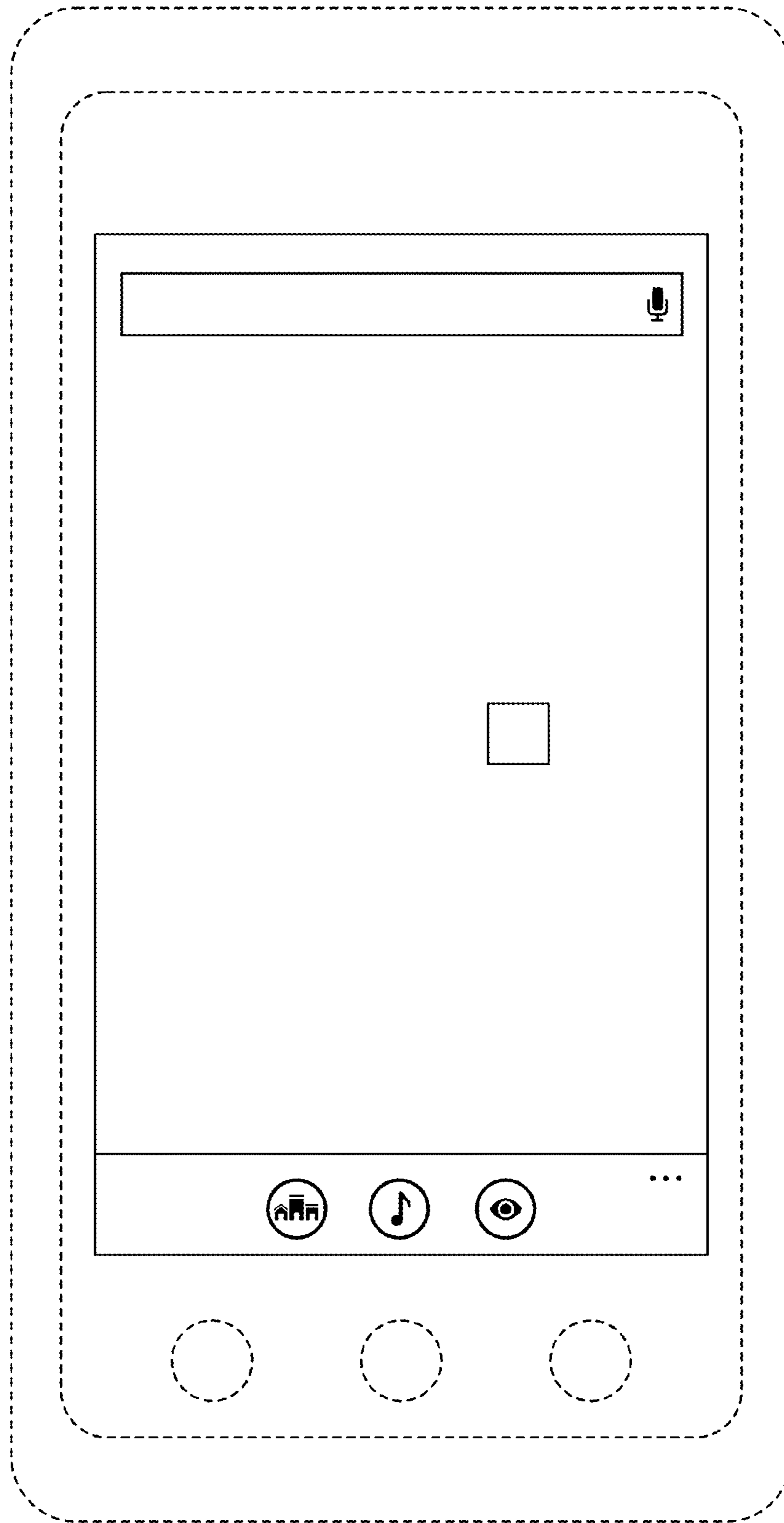

FIG. 26

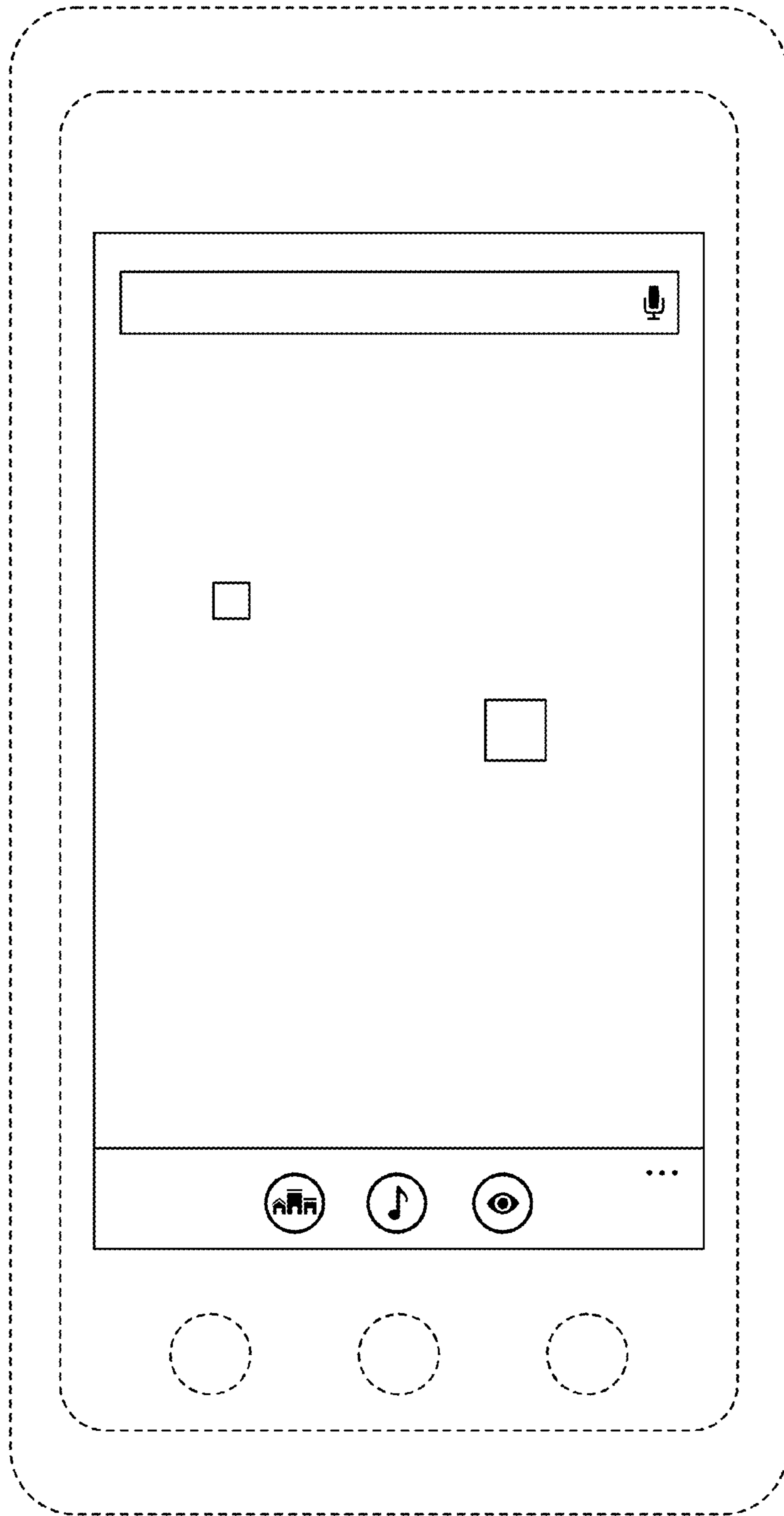

FIG. 27

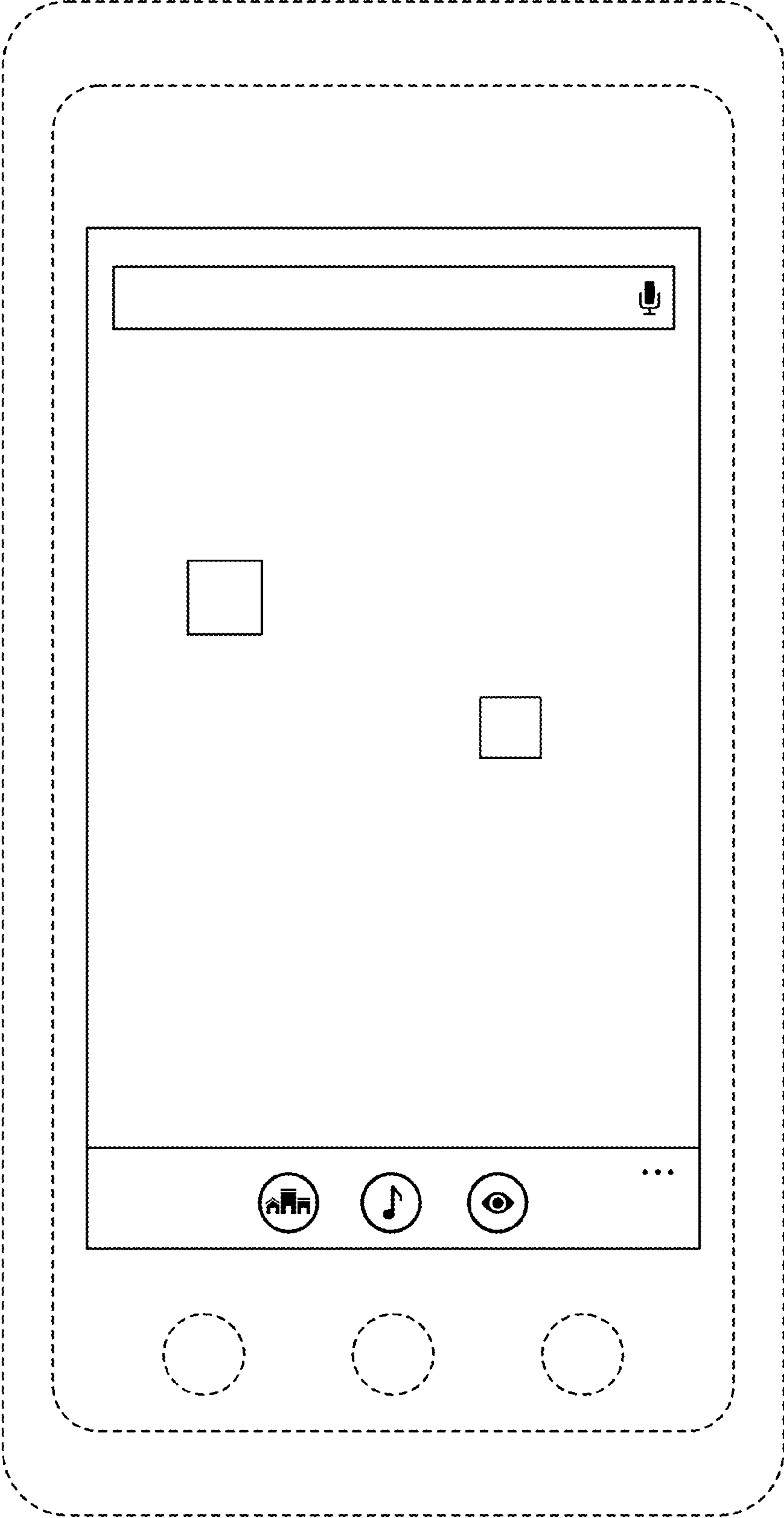

FIG. 28

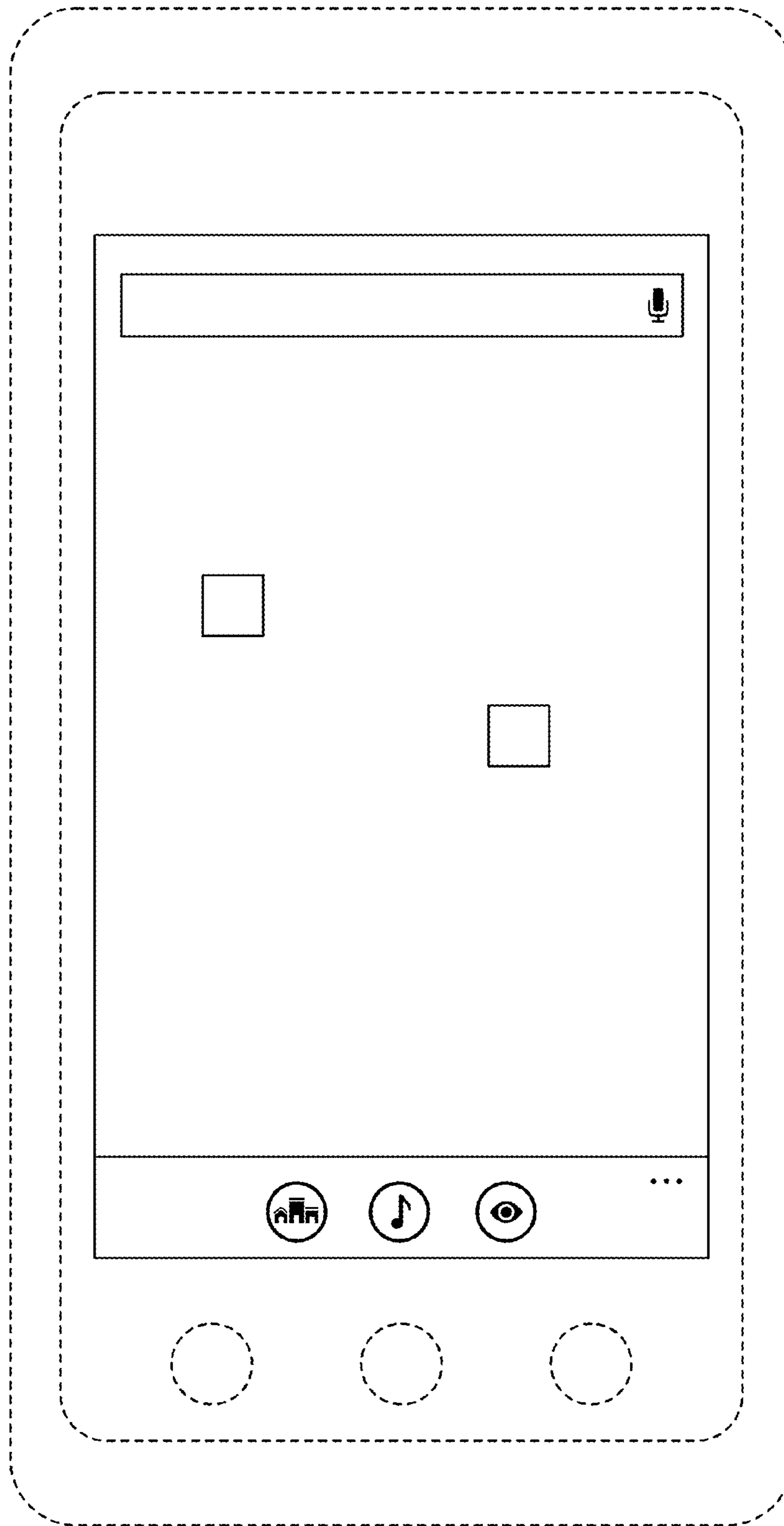

FIG. 29

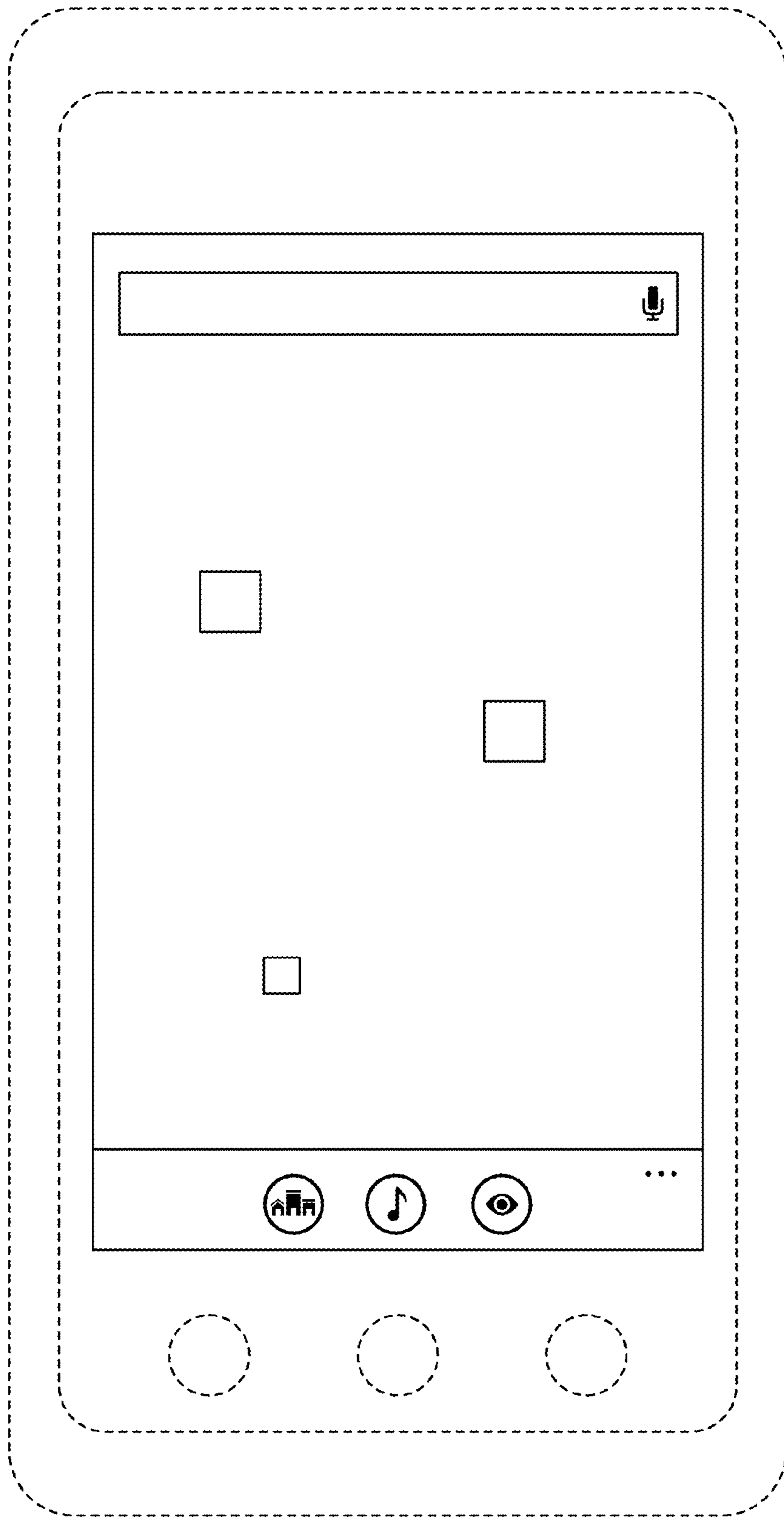

FIG. 30

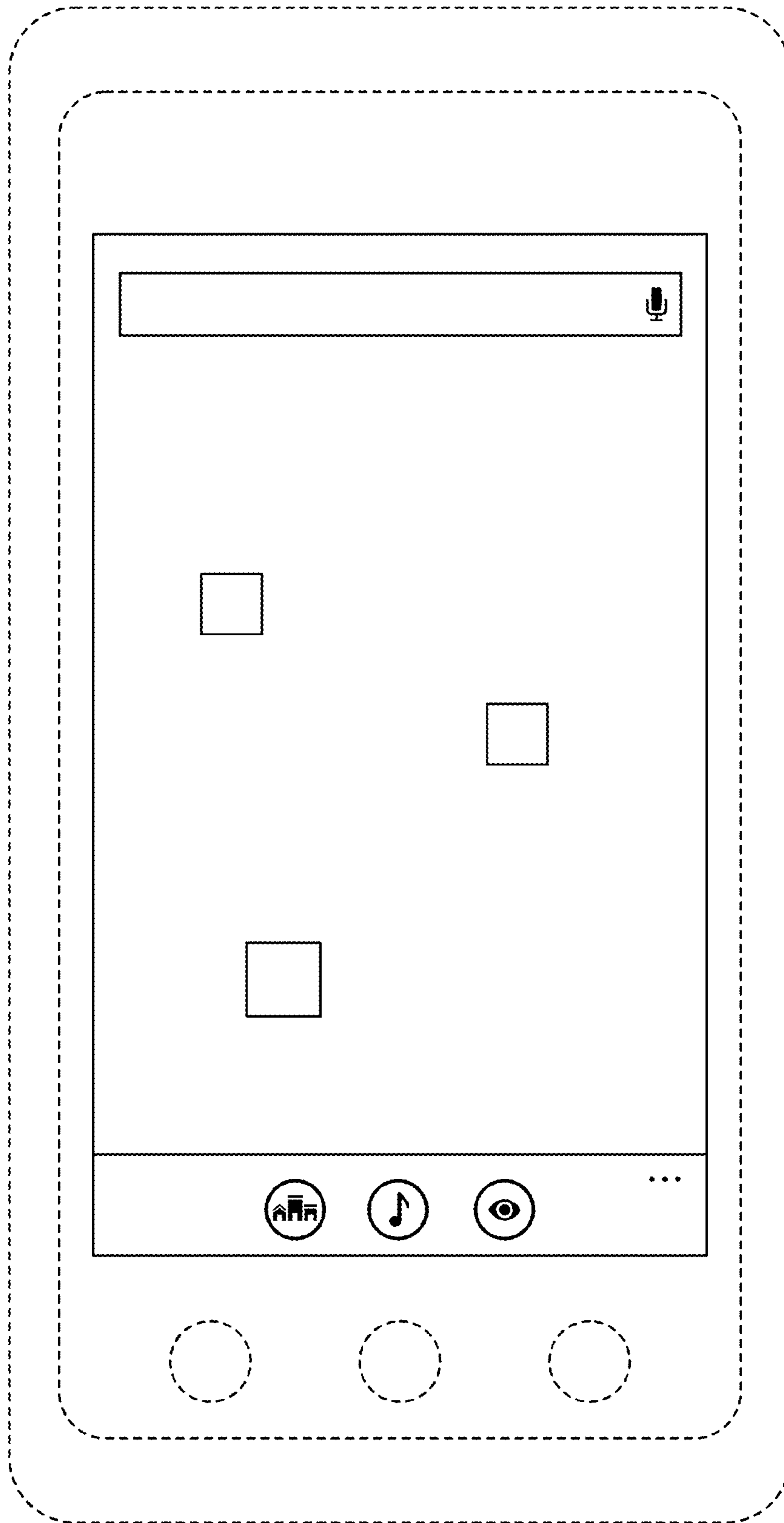

FIG. 31

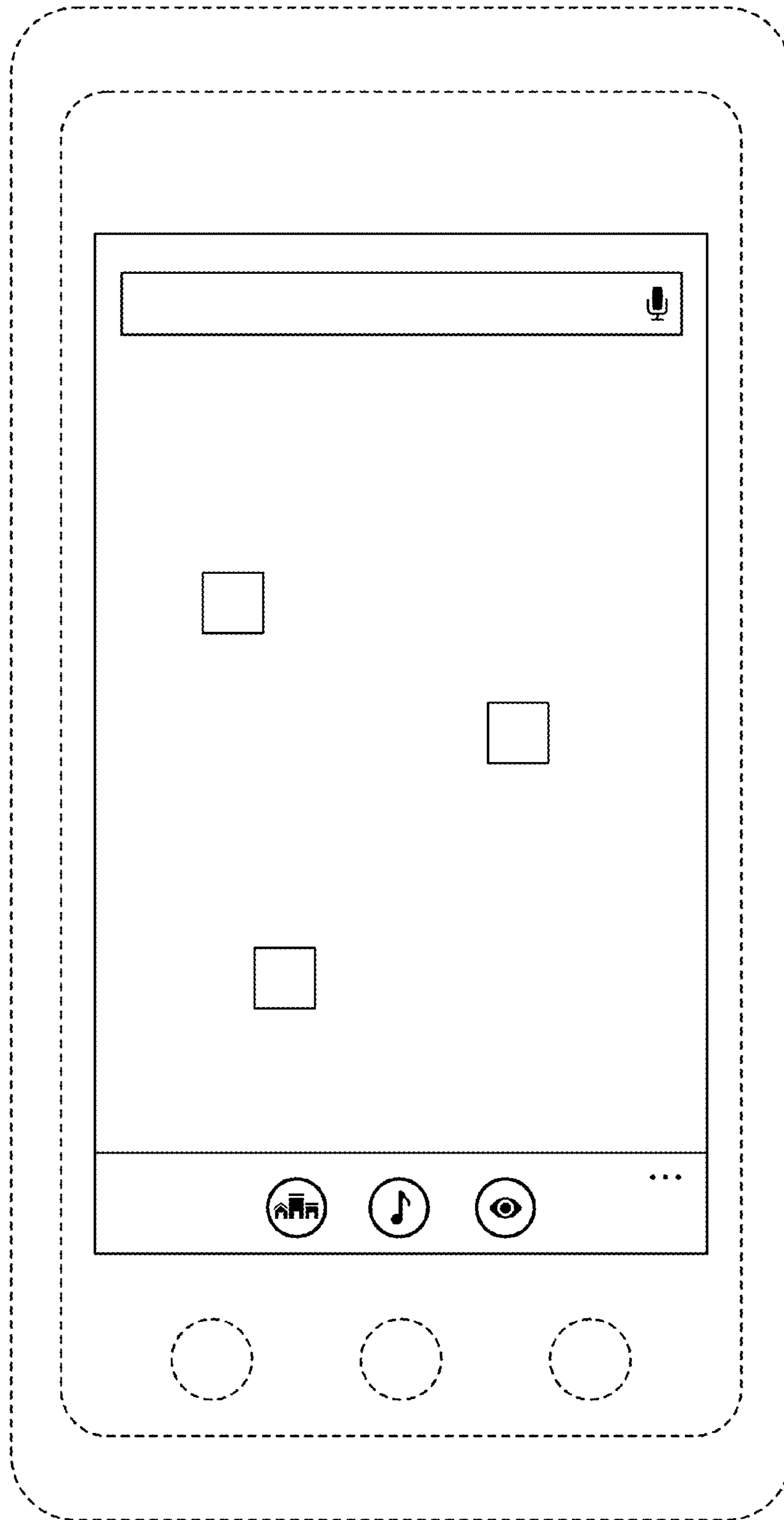

FIG. 32