



US00D718693S

(12) **United States Design Patent**
Lemen et al.

(10) **Patent No.:** **US D718,693 S**
(45) **Date of Patent:** **** Dec. 2, 2014**

(54) **TETHERING DEVICE**

(71) Applicants: **Scott Lemen**, Gallatin, TN (US);
Raymond L Ellison, Central City, KY (US)

(72) Inventors: **Scott Lemen**, Gallatin, TN (US);
Raymond L Ellison, Central City, KY (US)

(**) Term: **14 Years**

(21) Appl. No.: **29/469,771**

(22) Filed: **Oct. 15, 2013**

(51) **LOC (10) Cl.** **12-16**

(52) **U.S. Cl.**
USPC **D12/194**

(58) **Field of Classification Search**
CPC F01N 13/082; F01N 13/085; F01N 13/087
USPC D12/194; 29/525.01, 452, 450, 281.1,
29/281.4; 60/322; D23/265; D8/395
See application file for complete search history.

(56) **References Cited**

U.S. PATENT DOCUMENTS

867,814	A *	10/1907	Fornander	2/175.7
D353,477	S *	12/1994	Terry	D30/154
D369,959	S *	5/1996	Marsh et al.	D8/394
5,661,976	A *	9/1997	Clanton	60/322
7,273,413	B2 *	9/2007	Frink	454/63
D570,676	S *	6/2008	Hager	D8/396
D669,261	S *	10/2012	Tepper	D3/229
8,833,310	B2 *	9/2014	Konigsberg et al.	119/770

2013/0019592	A1 *	1/2013	Tkac	60/598
2014/0167403	A1 *	6/2014	Rakowicz et al.	285/18
2014/0175247	A1 *	6/2014	Churilla	248/317

* cited by examiner

Primary Examiner — Michael A Pratt

(74) *Attorney, Agent, or Firm* — Tanner Patent.com; Chris Tanner, Esq.

(57) **CLAIM**

The ornamental design for a tethering device, as shown and described.

DESCRIPTION

FIG. 1 is a perspective view of a tethering device; FIG. 2 is a side view of the tethering device of FIG. 1; FIG. 3 is a reversed side view of the tethering device of FIG. 1; FIG. 4 is a plan view of the tethering device of FIG. 1; FIG. 5 is an end view of the tethering device of FIG. 1; FIG. 6 is a flattened plan view of the tethering device of FIG. 1; FIG. 7 is another end view of the tethering device of FIG. 1; and, FIG. 8 is an additional perspective view of the tethering device of FIG. 1.

It is to be noted that the broken lines shown in FIG. 8 represent unclaimed environmental structure only and form no part of the claimed design.

1 Claim, 5 Drawing Sheets

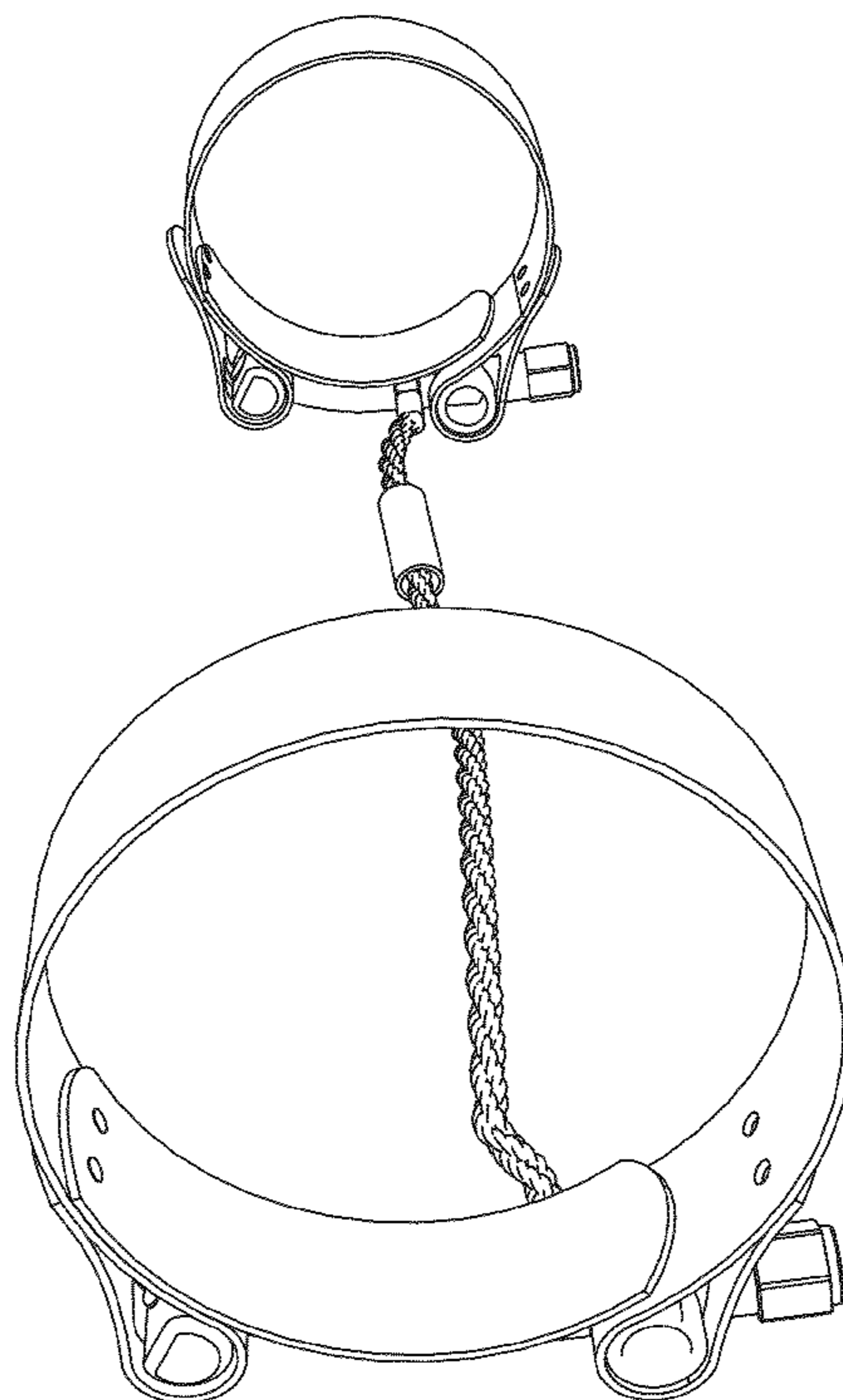

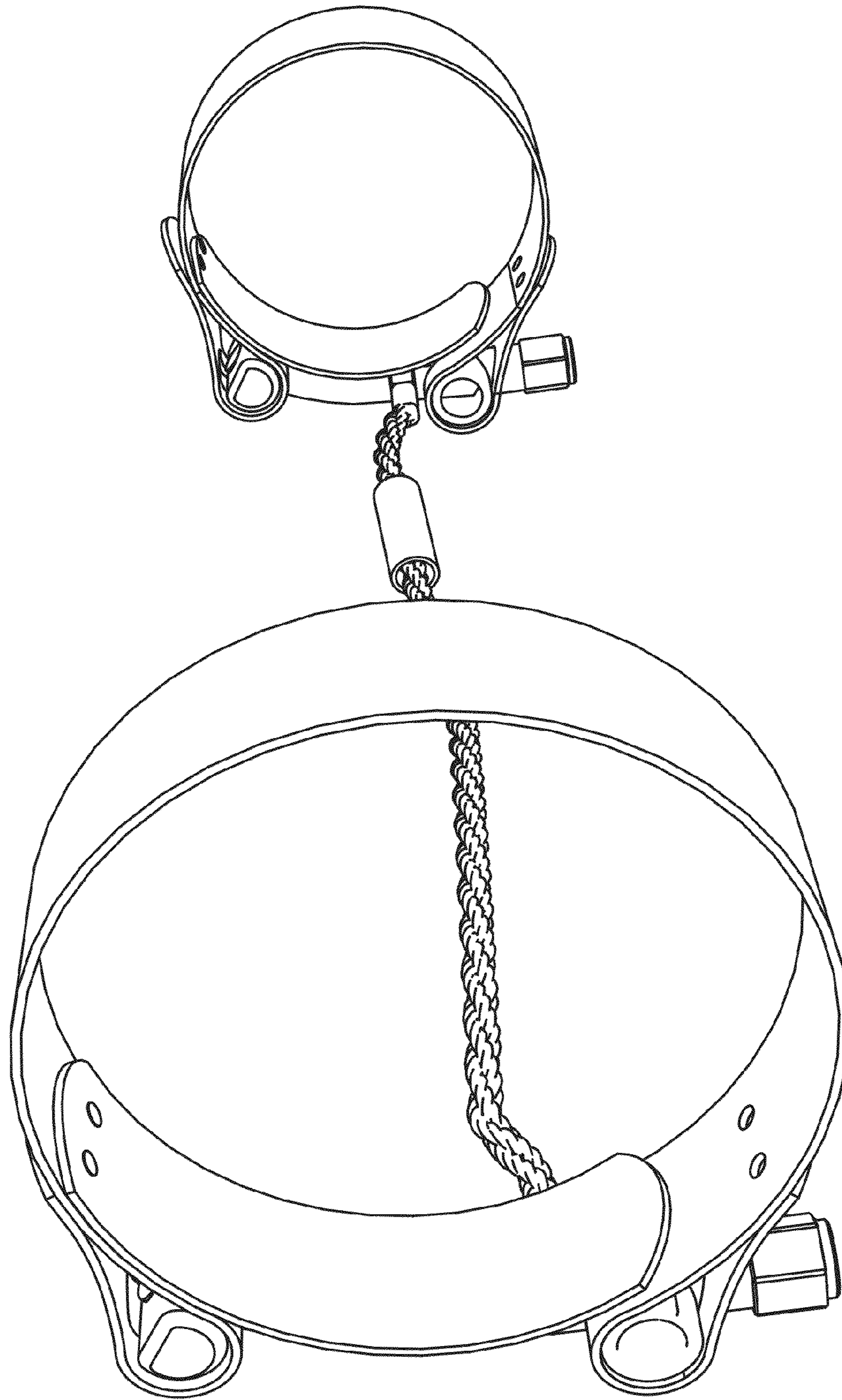

FIG. 1

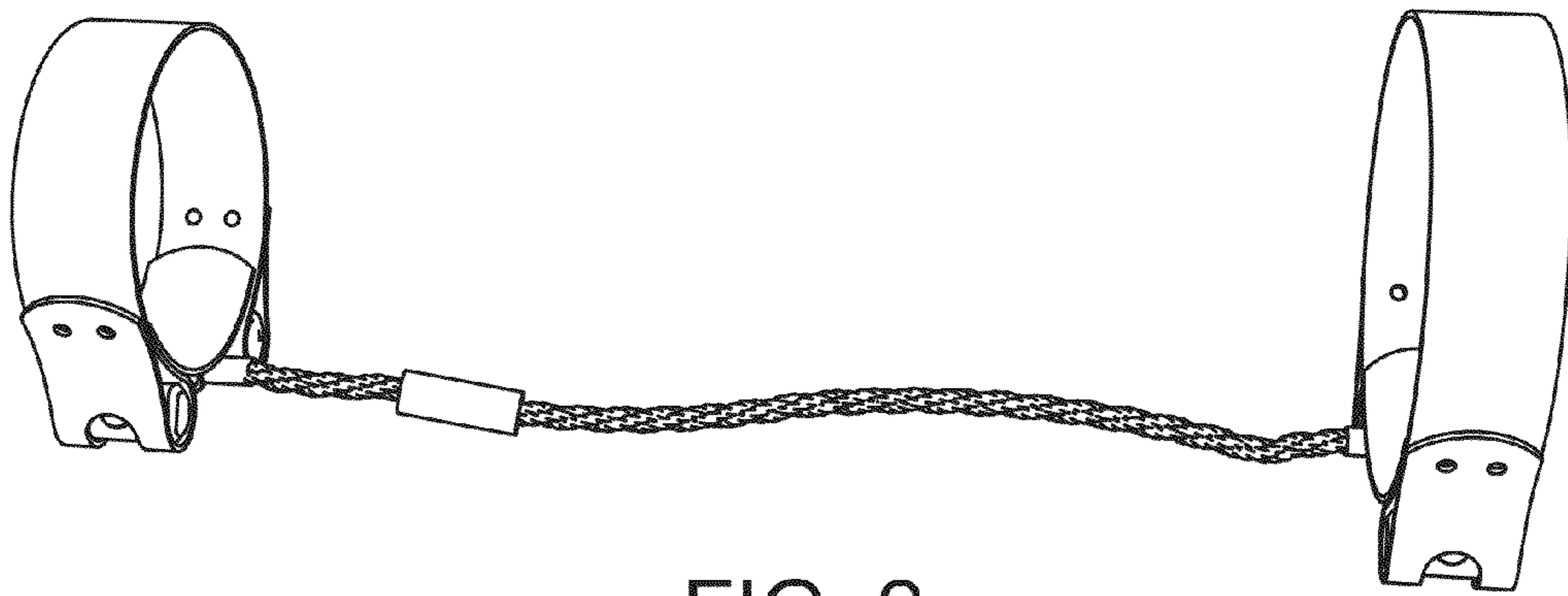

FIG. 2

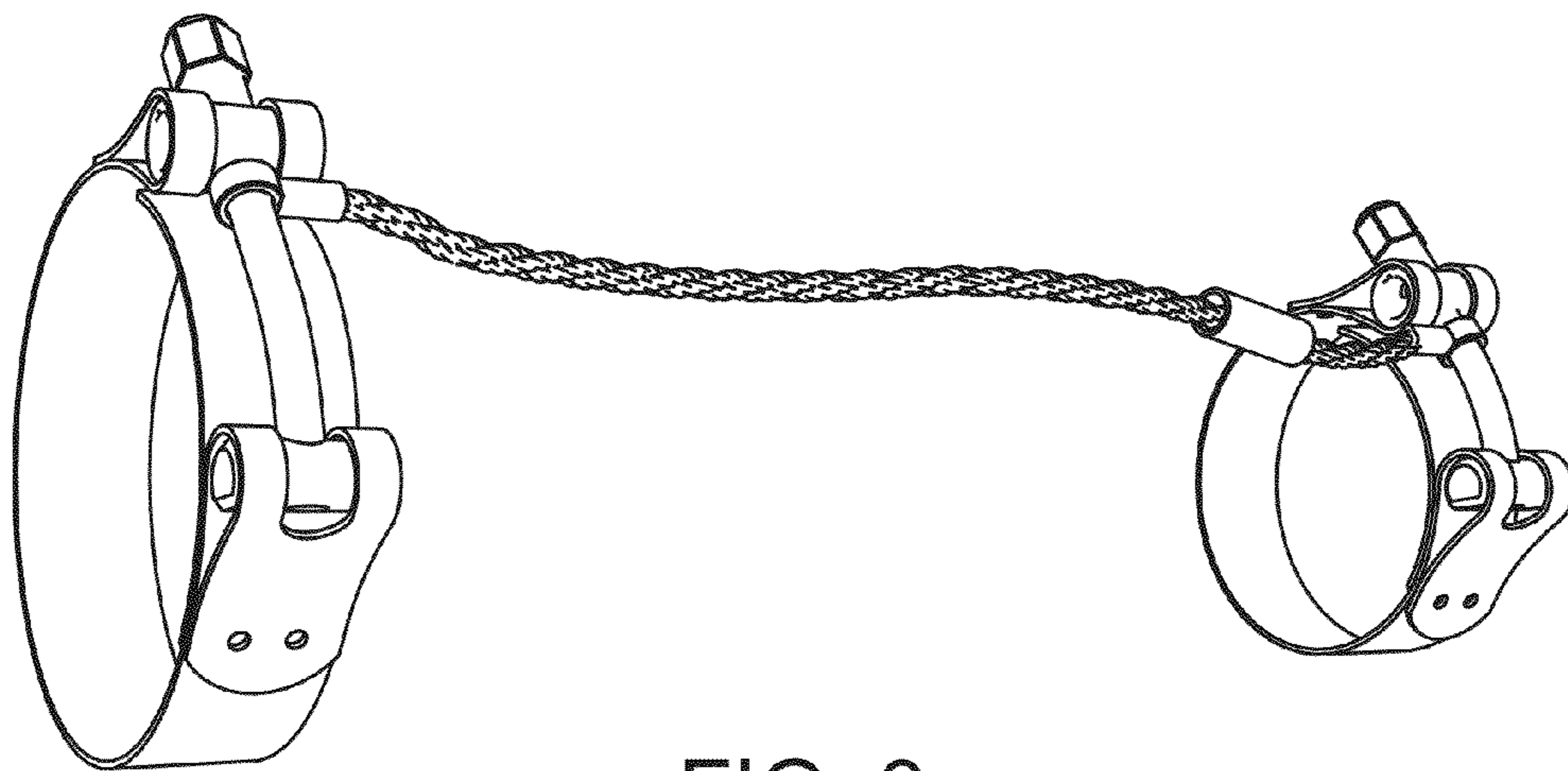

FIG. 3

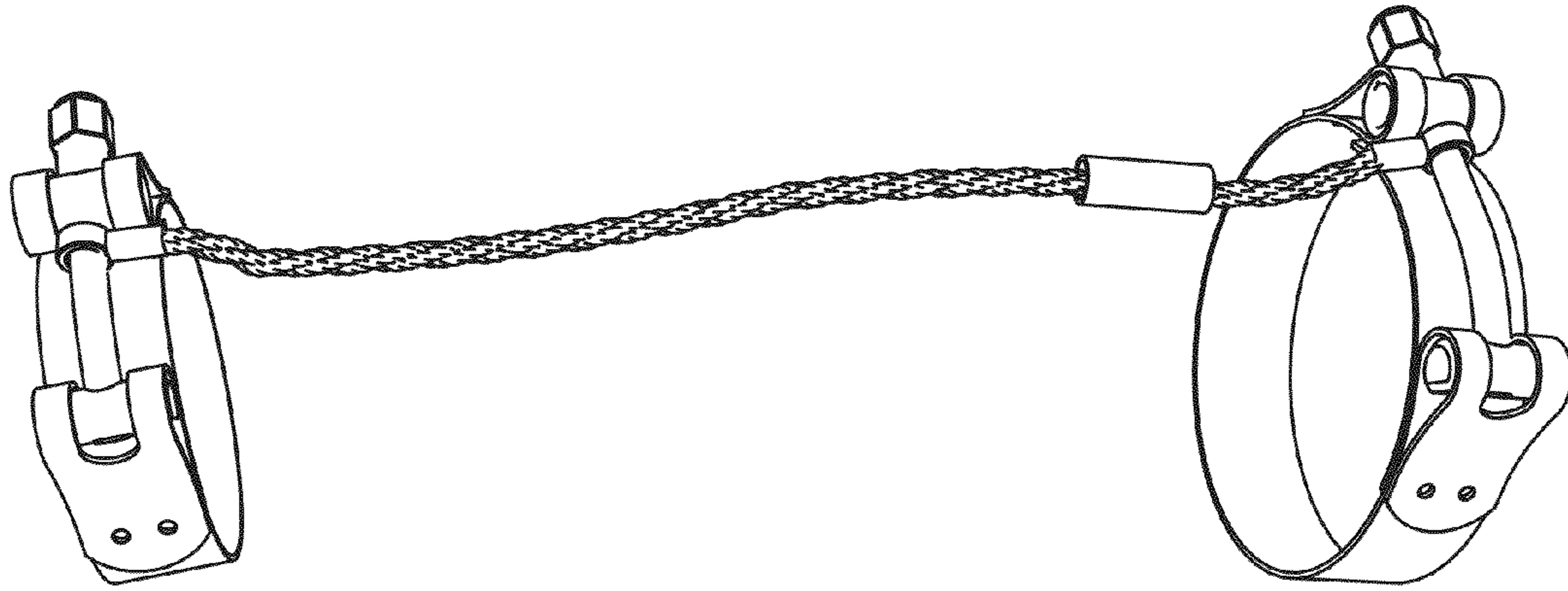

FIG. 4

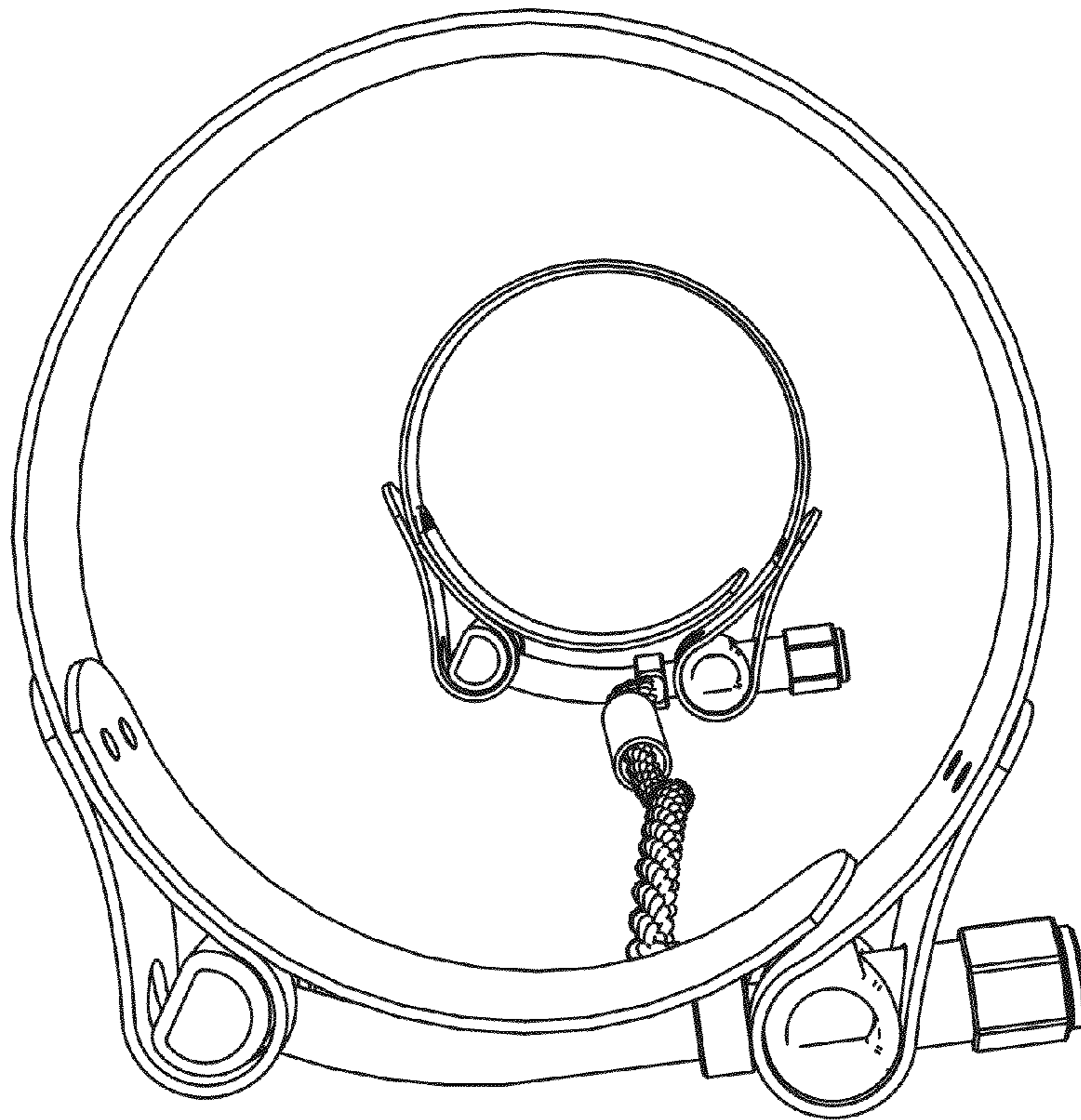

FIG. 5

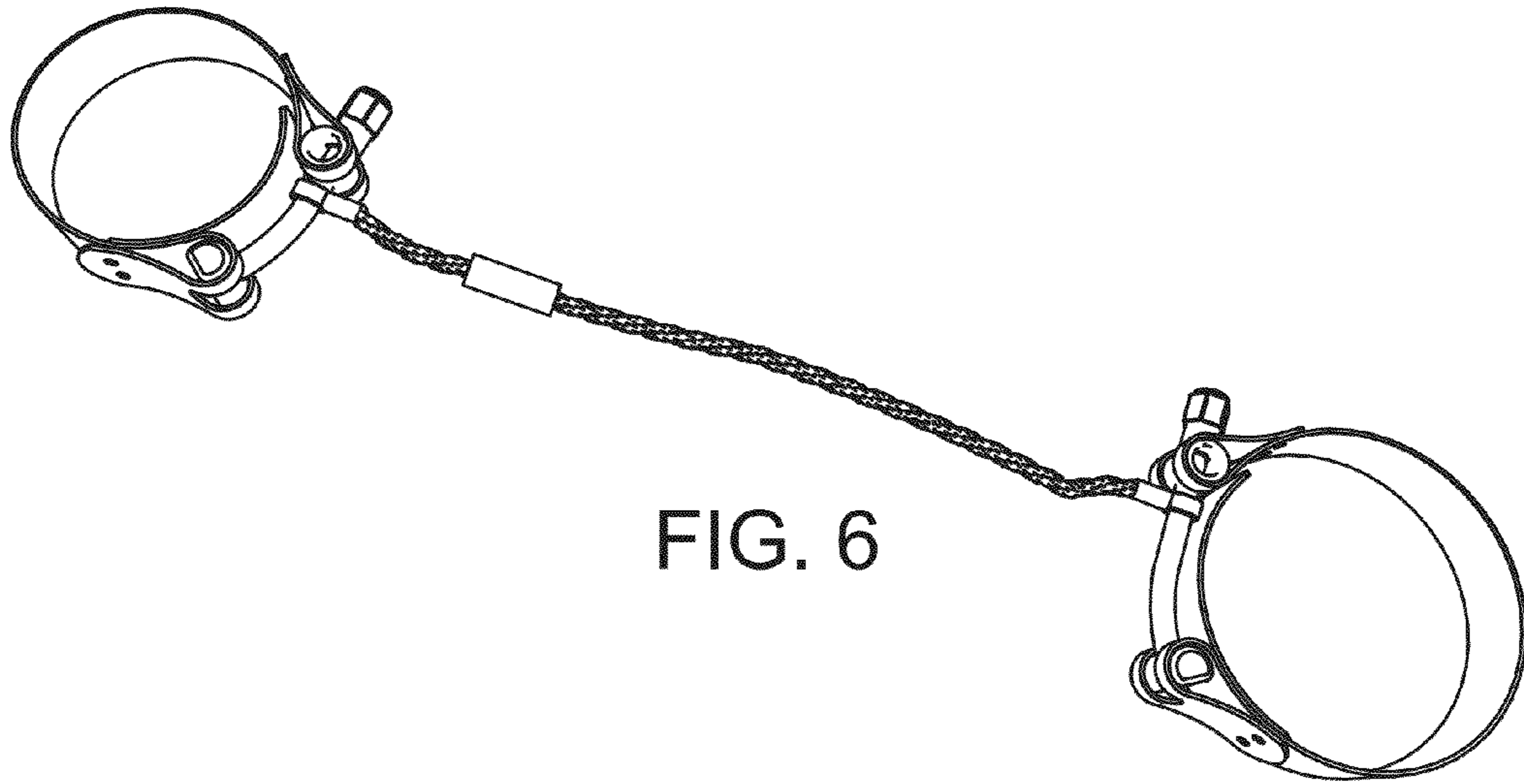

FIG. 6

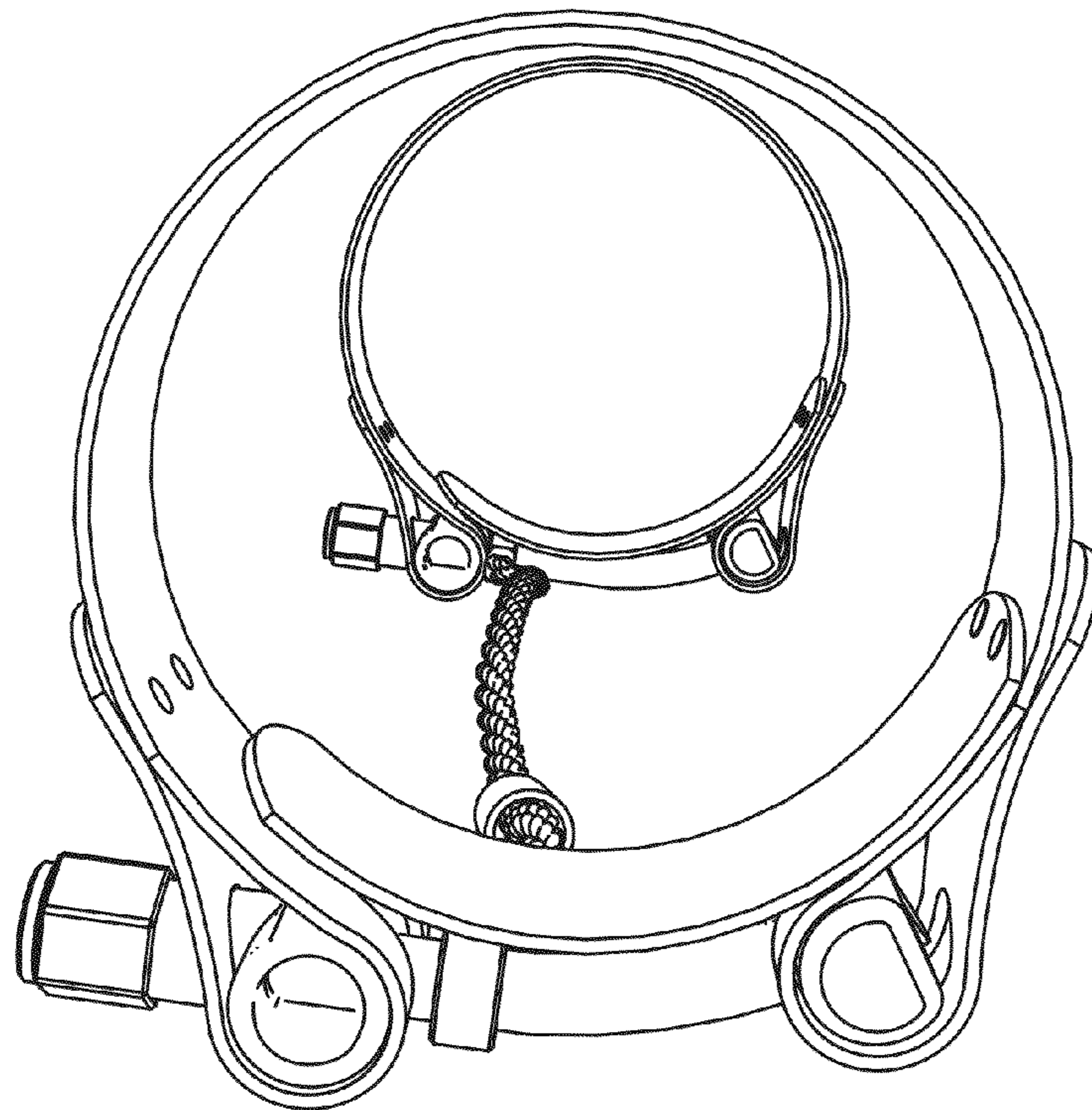

FIG. 7

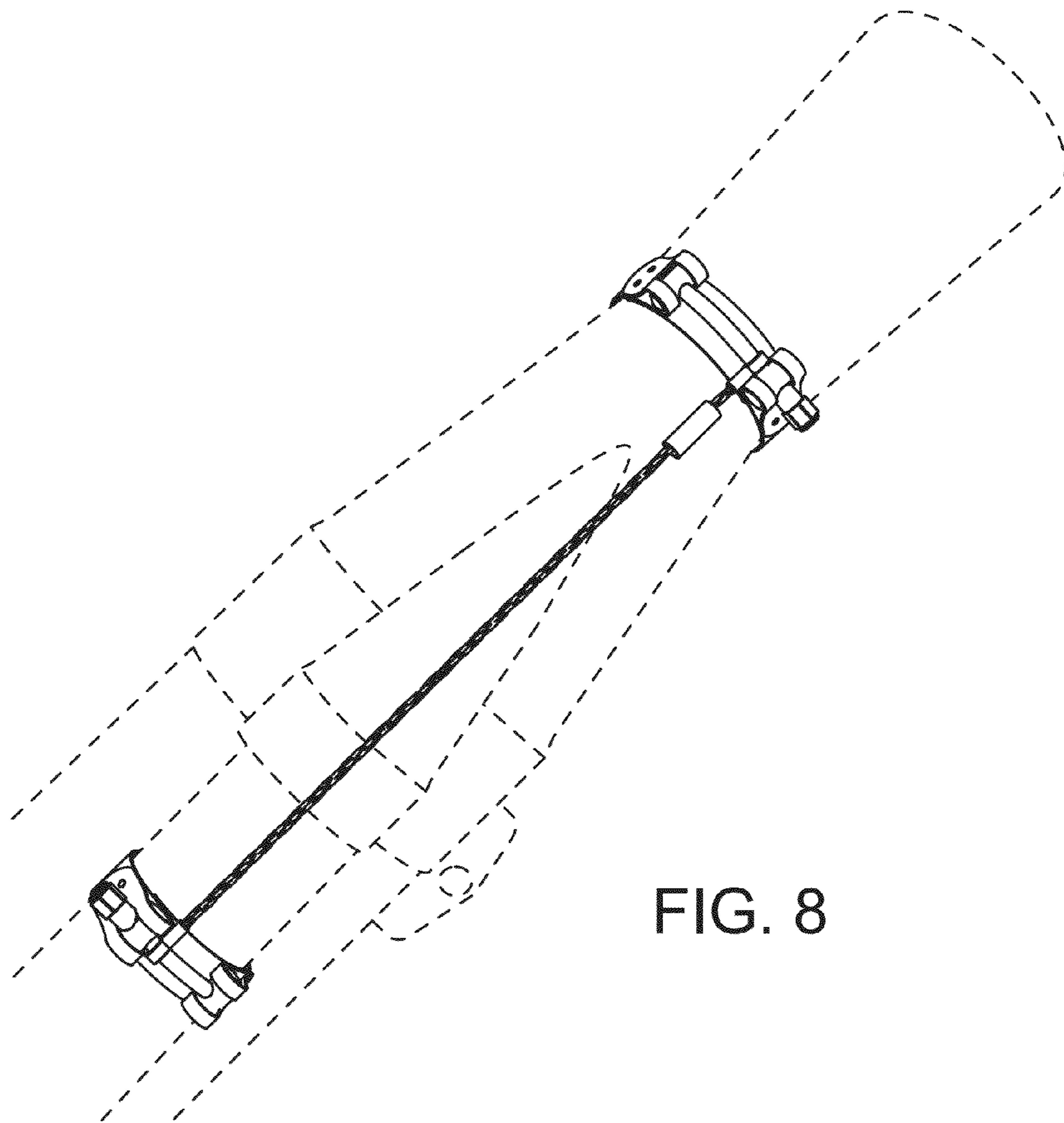

FIG. 8