



US00D718495S

(12) **United States Design Patent**  
**Okabe**

(10) **Patent No.:** **US D718,495 S**

(45) **Date of Patent:** **\*\* Nov. 25, 2014**

(54) **ELECTRIC SHAVER**

(71) Applicant: **Panasonic Corporation**, Osaka (JP)

(72) Inventor: **Kensaku Okabe**, Osaka (JP)

(73) Assignee: **Panasonic Corporation**, Osaka (JP)

(\*\*) Term: **14 Years**

(21) Appl. No.: **29/488,220**

(22) Filed: **Apr. 17, 2014**

(51) **LOC (10) Cl.** ..... **28-03**

(52) **U.S. Cl.**  
USPC ..... **D28/51**

(58) **Field of Classification Search**  
USPC ..... D28/49-54, 44-48; 30/34.05, 32, 34.1,  
30/34.2, 43-43.92, 29.5, 526-527, 44-45,  
30/341, 272.1, 226-227, 231, 233-233.5,  
30/537  
See application file for complete search history.

(56) **References Cited**

**U.S. PATENT DOCUMENTS**

D479,360 S *	9/2003	Nishizawa et al.	.....	D28/49
D481,491 S *	10/2003	Nishizawa et al.	.....	D28/49
D549,875 S *	8/2007	Akahori et al.	.....	D28/51
D571,956 S *	6/2008	Nishizawa	.....	D28/49
D571,957 S *	6/2008	Nishizawa	.....	D28/51
D587,849 S *	3/2009	Nishizawa	.....	D28/51
D621,097 S *	8/2010	Nishizawa	.....	D28/51
D623,353 S *	9/2010	Nishizawa	.....	D28/52
D648,482 S *	11/2011	Kim	.....	D28/50

D648,895 S *	11/2011	Ino	.....	D28/49
D674,143 S *	1/2013	Ino et al.	.....	D28/51
D695,963 S *	12/2013	Ino	.....	D28/51
D697,265 S *	1/2014	Bergese	.....	D28/53

**FOREIGN PATENT DOCUMENTS**

JP	D1207548	6/2004
JP	D1268231	4/2006
JP	D1421412	8/2011

\* cited by examiner

*Primary Examiner* — Jennifer Rivard

(74) *Attorney, Agent, or Firm* — Panasonic Patent Center

(57) **CLAIM**

I claim the ornamental design for an electric shaver, as shown and described.

**DESCRIPTION**

FIG. 1 is a front perspective of view an electric shaver of the present invention;  
FIG. 2 is a rear perspective view thereof;  
FIG. 3 is a front view thereof;  
FIG. 4 is a first side view thereof;  
FIG. 5 is a second side view thereof;  
FIG. 6 is a rear view thereof;  
FIG. 7 is a top view thereof; and,  
FIG. 8 is a bottom view thereof.

The broken line showing of electric shaver is included for the purpose of illustrating environment and forms no part of the claimed design. The dash-dot lines represent the bounds of the claim and form no part of the claimed design.

**1 Claim, 8 Drawing Sheets**

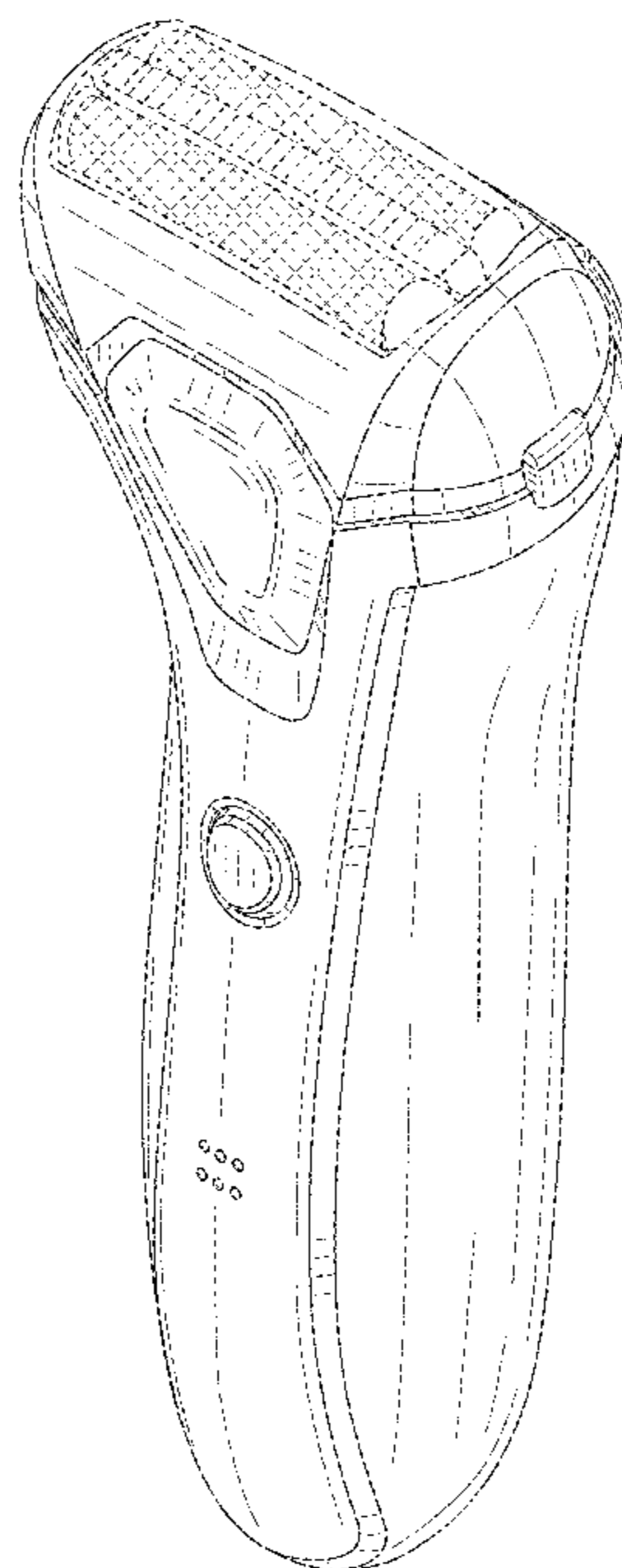

FIG. 1

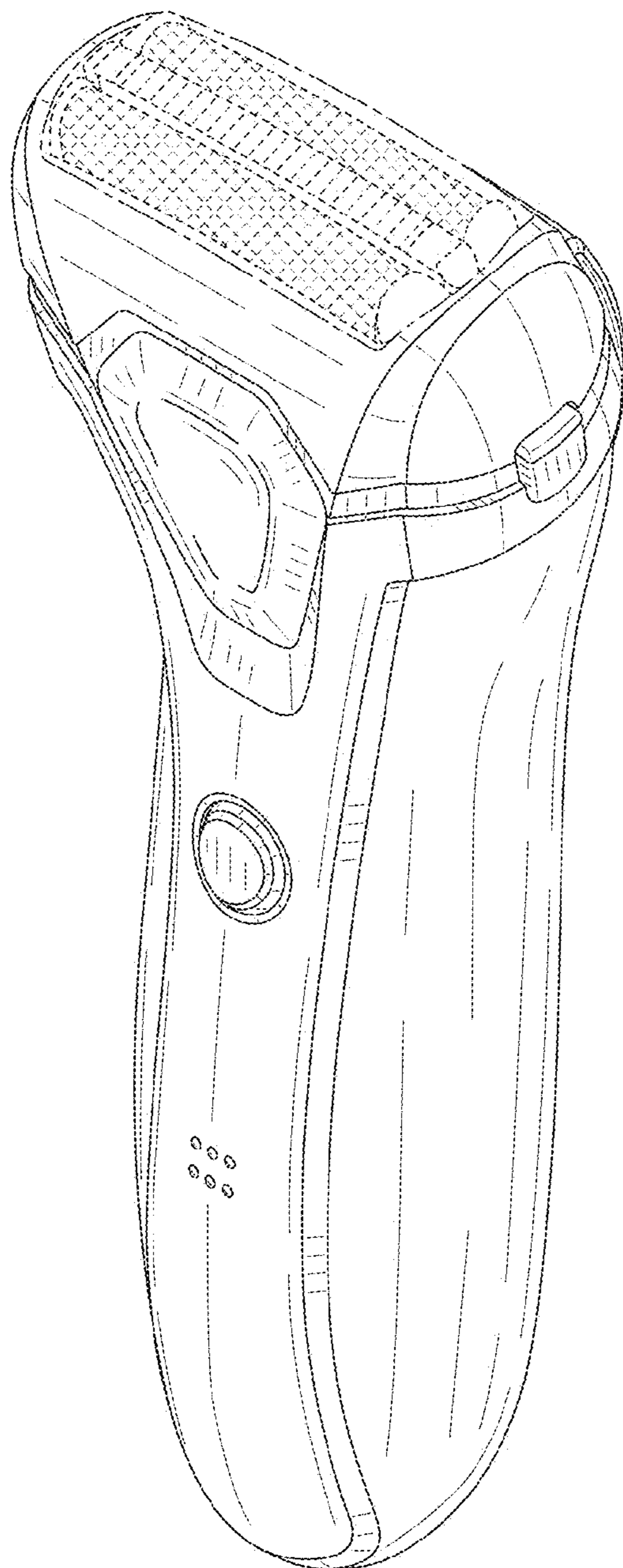

FIG. 2

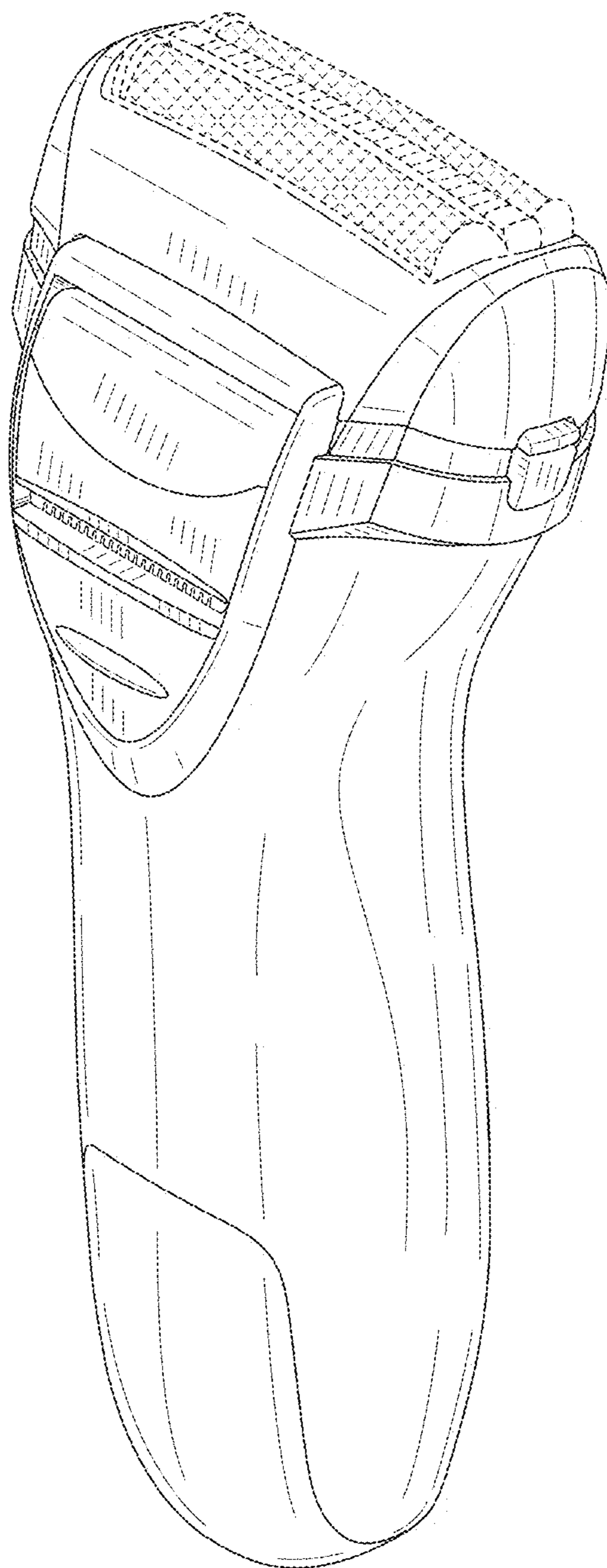

FIG. 3

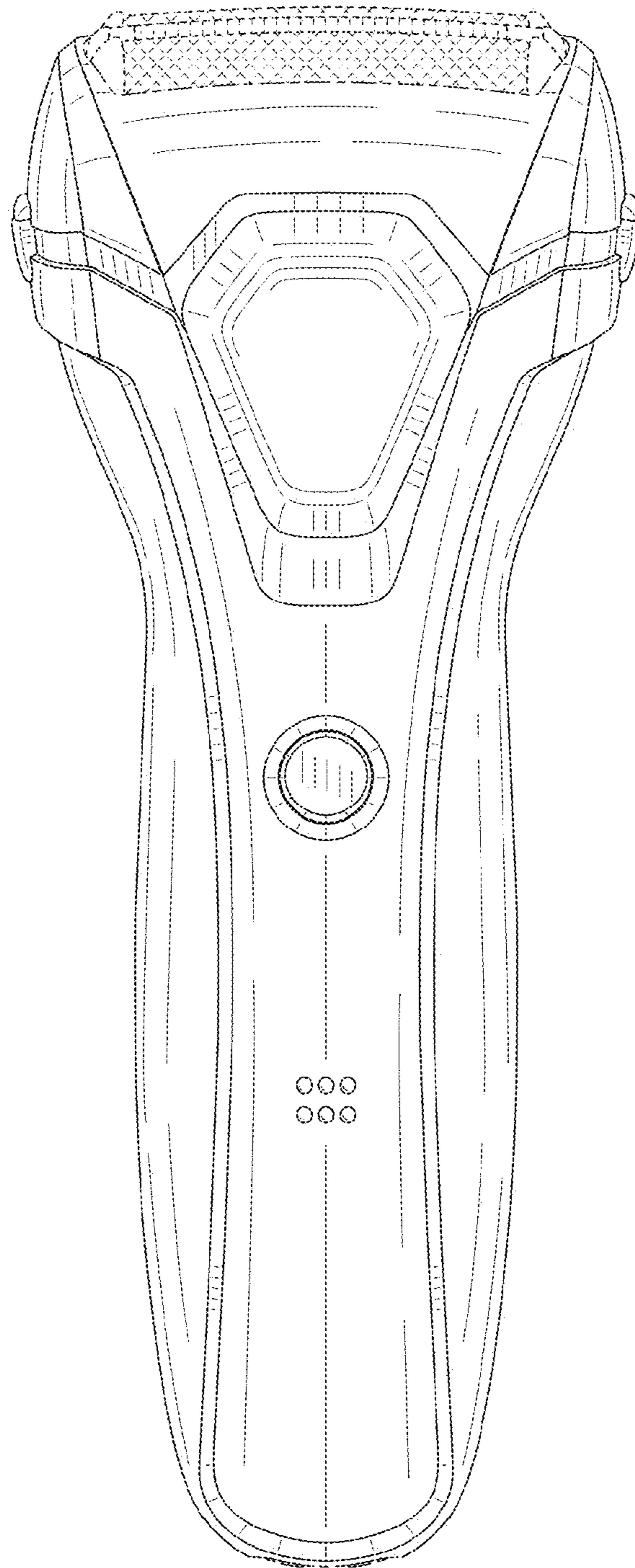

FIG. 4

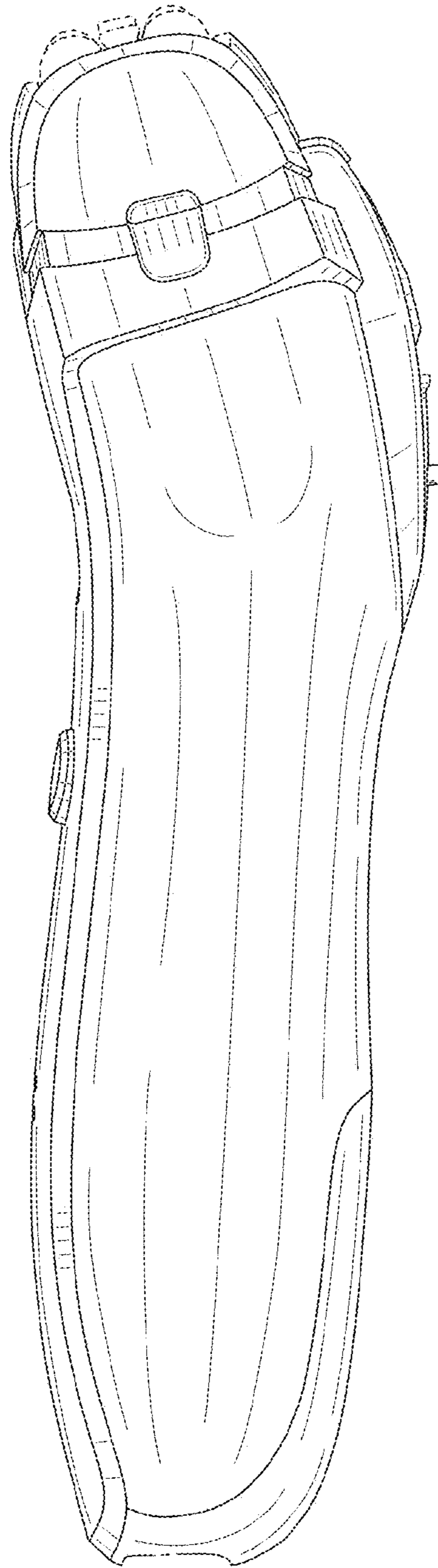

FIG. 5

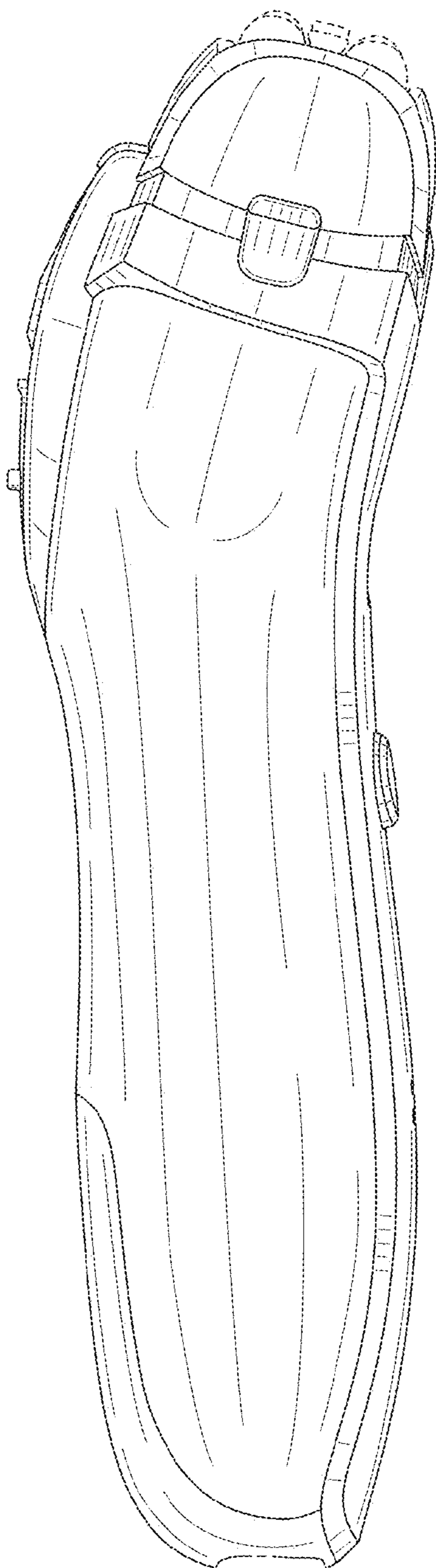

FIG. 6

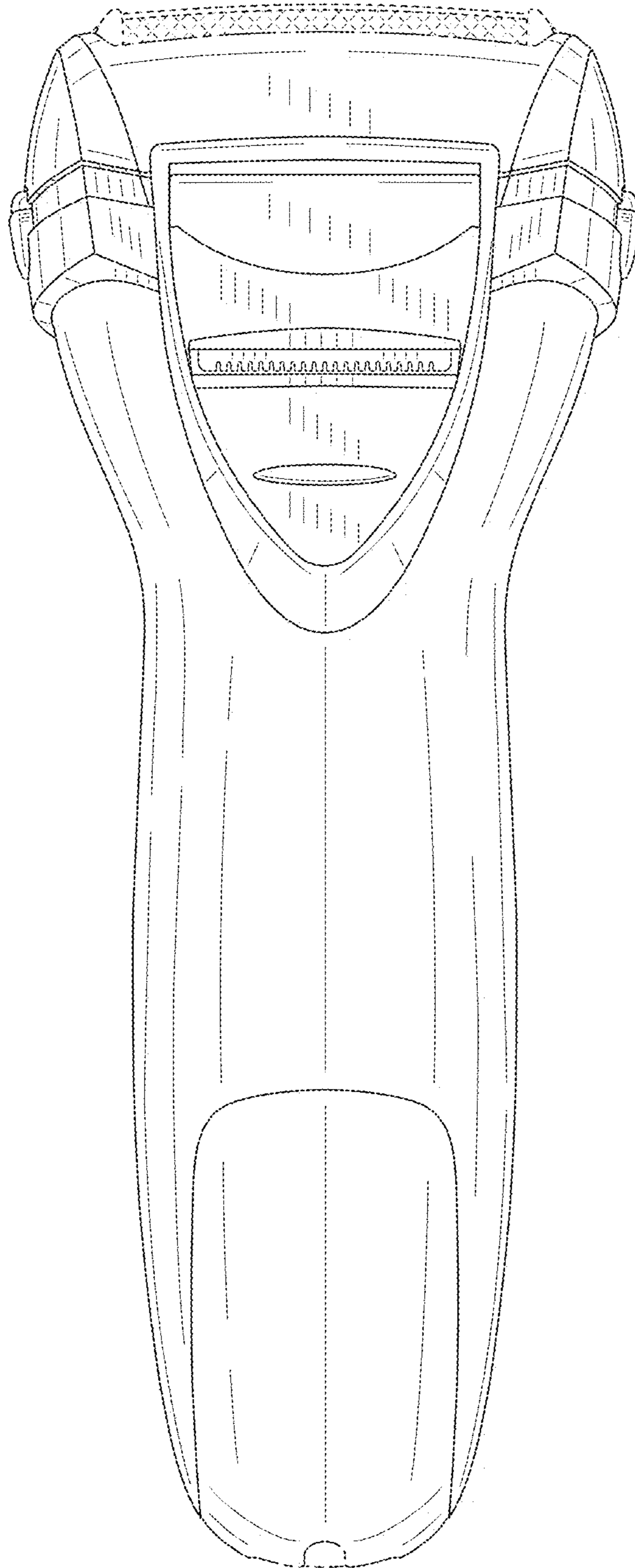

FIG. 7

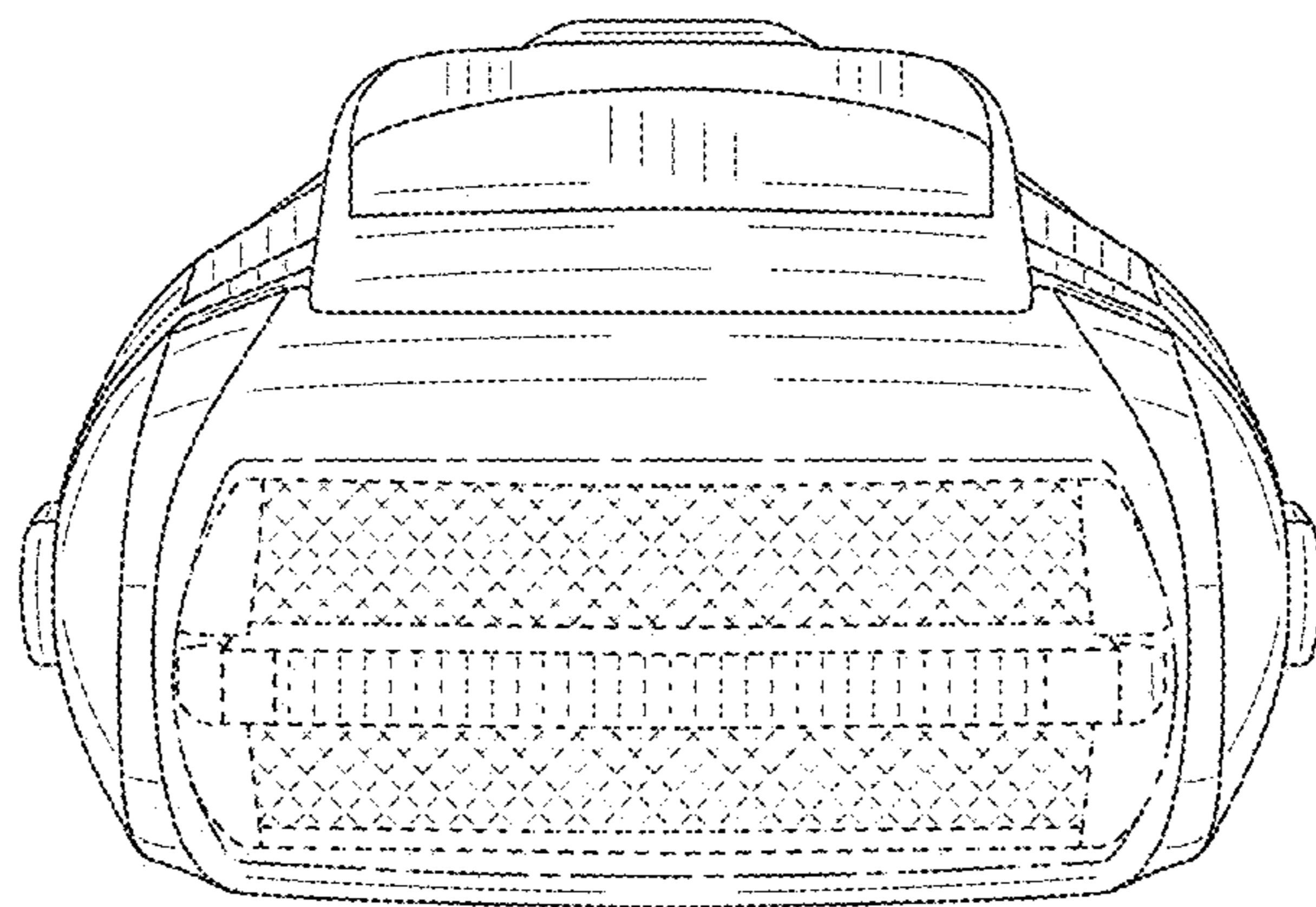



FIG. 8

