



US00D718493S

(12) **United States Design Patent**  
**Stern**

(10) **Patent No.:** **US D718,493 S**

(45) **Date of Patent:** **\*\* Nov. 25, 2014**

(54) **ELECTRONIC CIGARETTE HOLDER**

D656,094 S \* 3/2012 Wu ..... D13/108  
D700,994 S \* 3/2014 Alarcon et al. .... D27/189  
D706,976 S \* 6/2014 Wu ..... D27/189

(71) Applicant: **Steven Stern**, Carlsbad, CA (US)

\* cited by examiner

(72) Inventor: **Steven Stern**, Carlsbad, CA (US)

*Primary Examiner* — Catheri Oliver-Garcia

(73) Assignee: **Steven Stern**, Carlsbad, CA (US)

(74) *Attorney, Agent, or Firm* — Daniel Xu

(\*\*) Term: **14 Years**

(57) **CLAIM**

(21) Appl. No.: **29/481,347**

I claim the ornamental design for an electronic cigarette holder, as shown and described.

(22) Filed: **Feb. 5, 2014**

**DESCRIPTION**

(51) **LOC (10) Cl.** ..... **27-06**

(52) **U.S. Cl.**  
USPC ..... **D27/189**

(58) **Field of Classification Search**  
USPC ..... D27/189, 120–103, 105, 172; D9/423,  
D9/415, 420; D3/294, 293; 206/242, 259,  
206/260–261, 268, 273, 270, 256, 86, 89;  
224/666, 679, 681

See application file for complete search history.

FIG. 1 is a perspective view of an electronic cigarette holder showing my new design;  
FIG. 2 is a front view thereof;  
FIG. 3 is a rear view thereof;  
FIG. 4 a left side view thereof;  
FIG. 5 is a right side view thereof;  
FIG. 6 is a top view thereof;  
FIG. 7 is a bottom view thereof;  
FIG. 8 is a top view of the electronic cigarette holder with the cover opened;  
FIG. 9 is a perspective elevation view of the electronic cigarette holder with the cover opened; and,  
FIG. 10 is a front elevation view of the electronic cigarette holder with the cover opened.

The broken lines showing the contents of the electronic cigarette holder are for illustrative purposes only and form no part of the claimed design.

(56) **References Cited**

U.S. PATENT DOCUMENTS

5,277,315 A \* 1/1994 Plein ..... 206/270  
D355,275 S \* 2/1995 Focke ..... D27/189  
D386,001 S \* 11/1997 Saffran ..... D9/423  
D472,012 S \* 3/2003 South ..... D27/105  
D493,617 S \* 8/2004 Armato ..... D3/294  
D560,489 S \* 1/2008 Satnick ..... D9/415  
D569,720 S \* 5/2008 Lablaine ..... D9/420

**1 Claim, 8 Drawing Sheets**

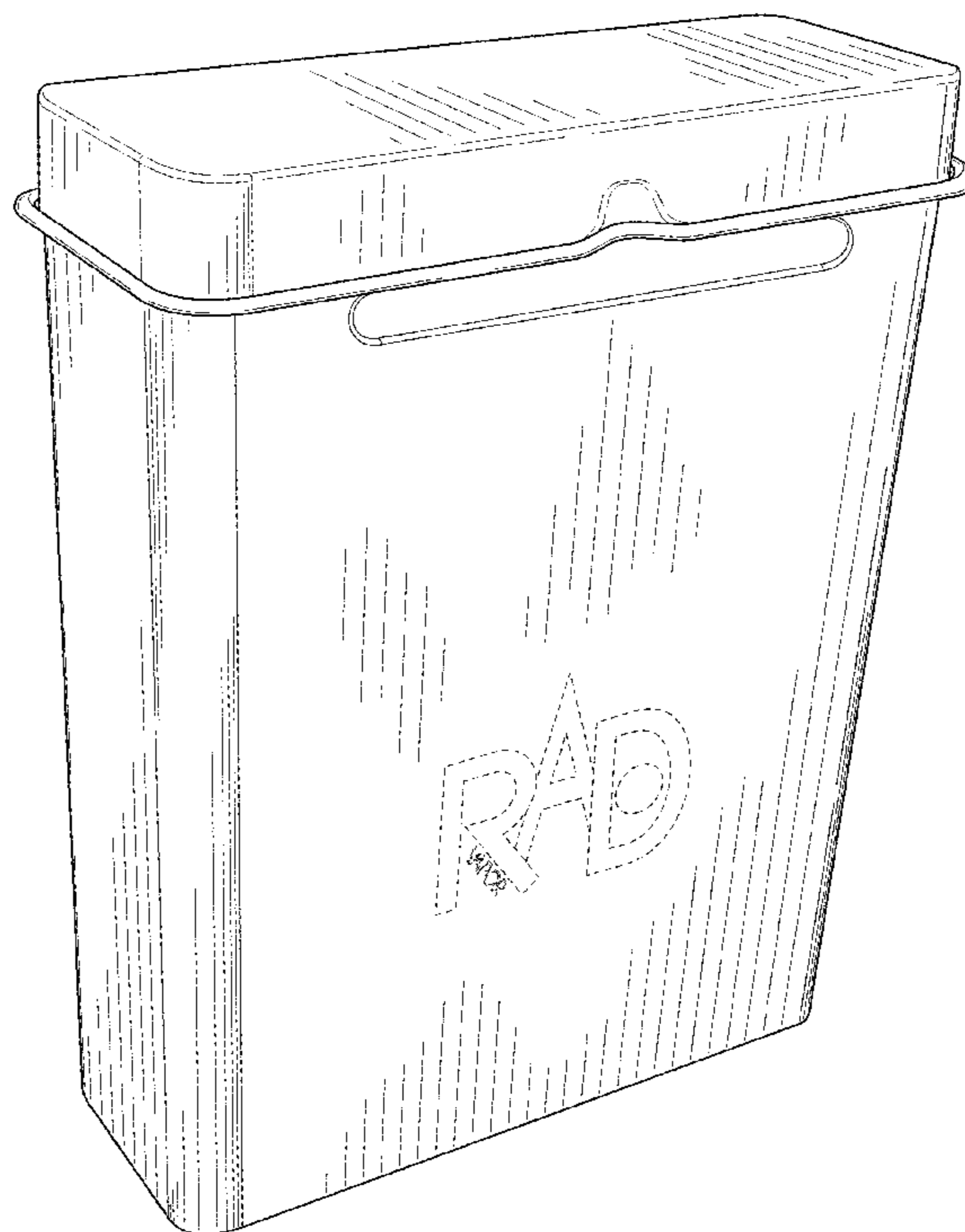

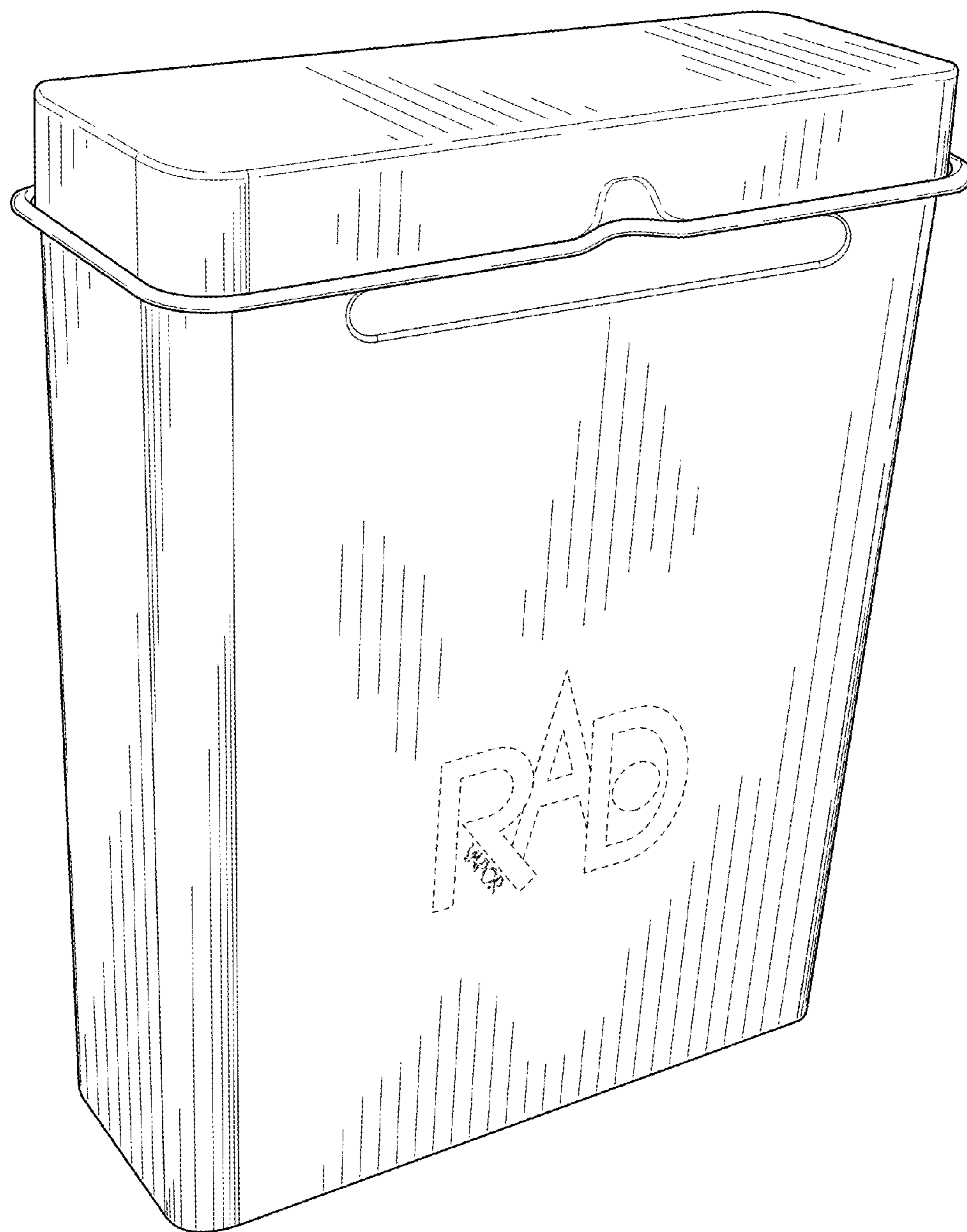

FIG. 1

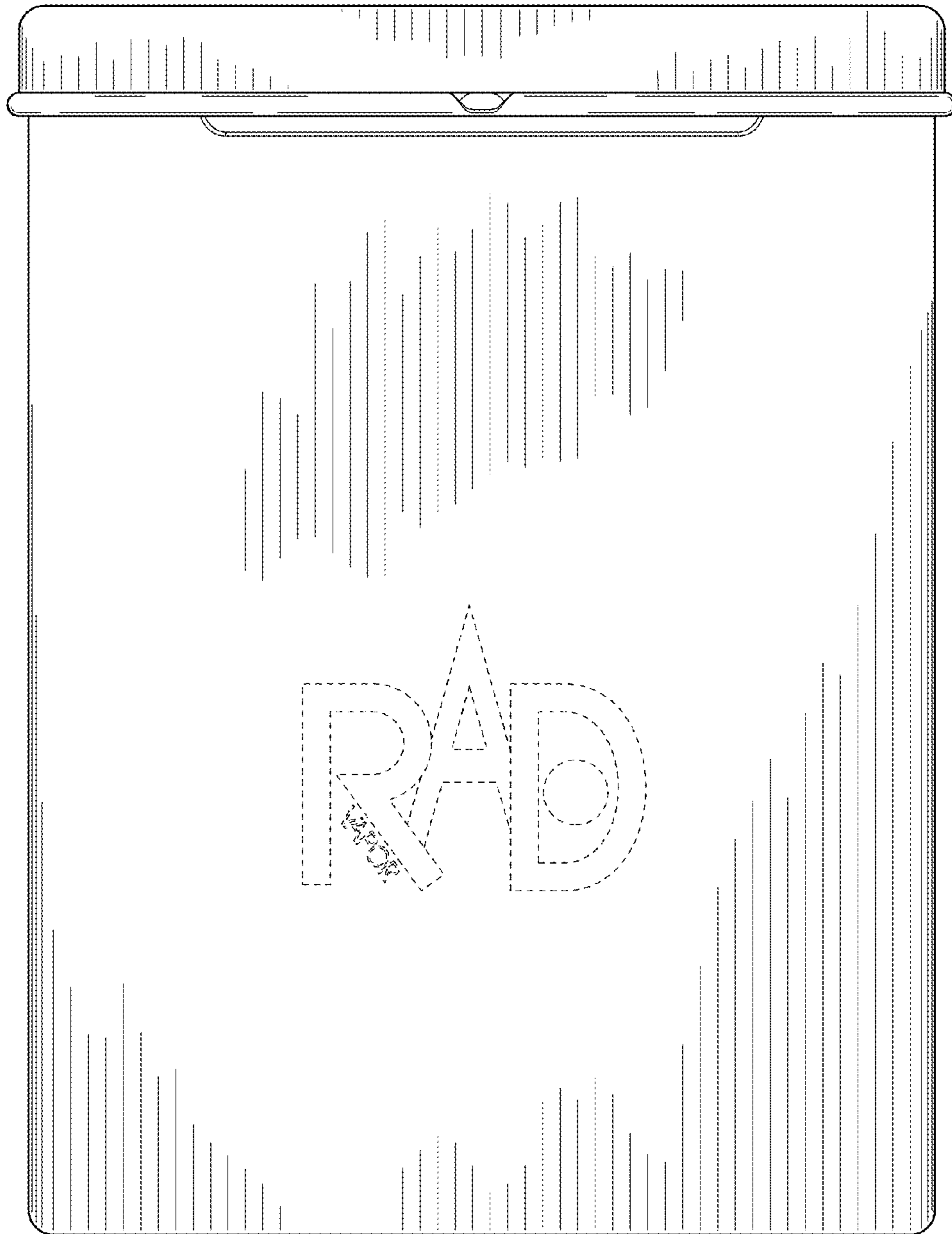

FIG. 2

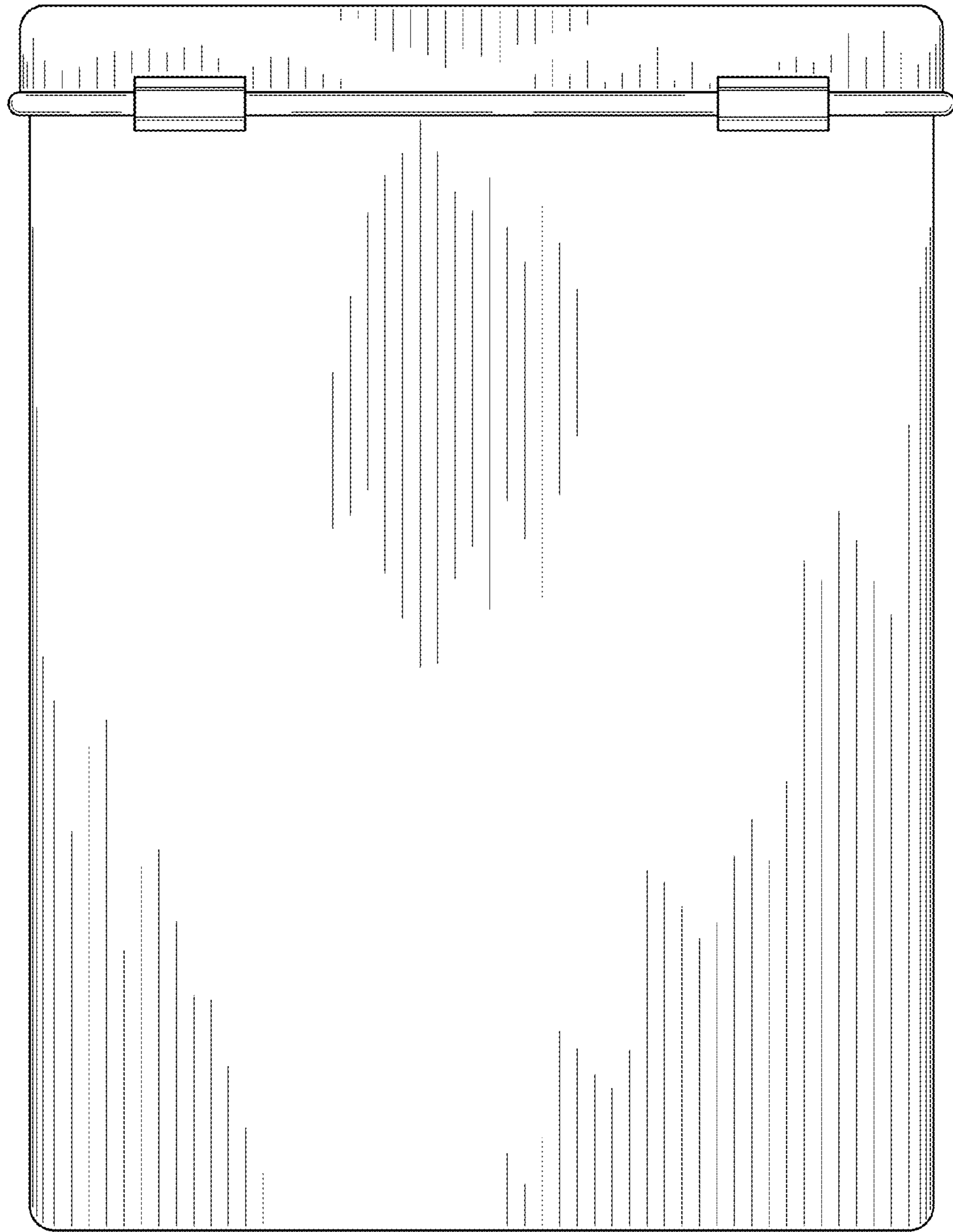

FIG. 3

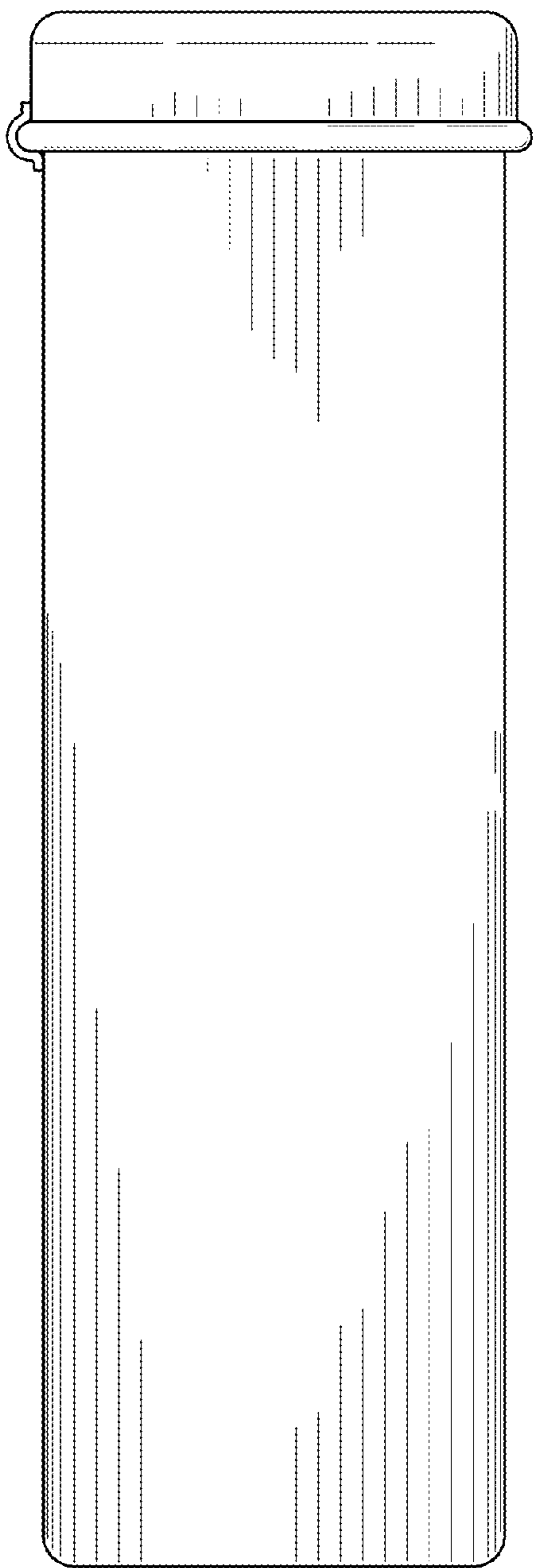

FIG. 4

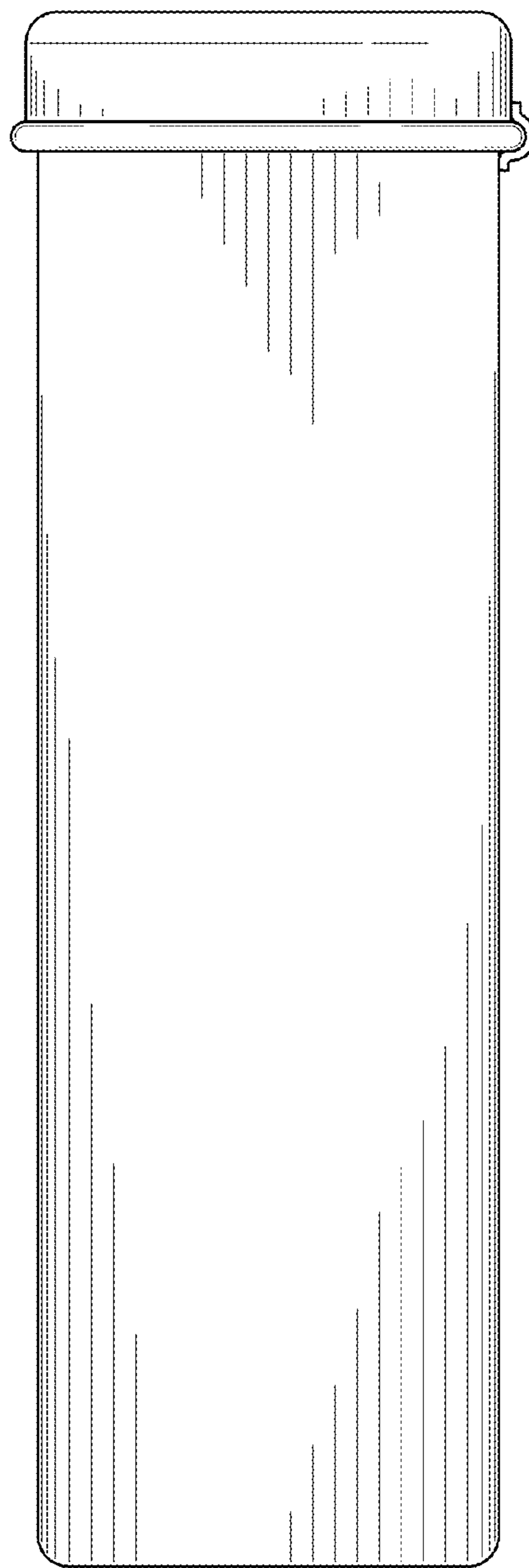

FIG. 5

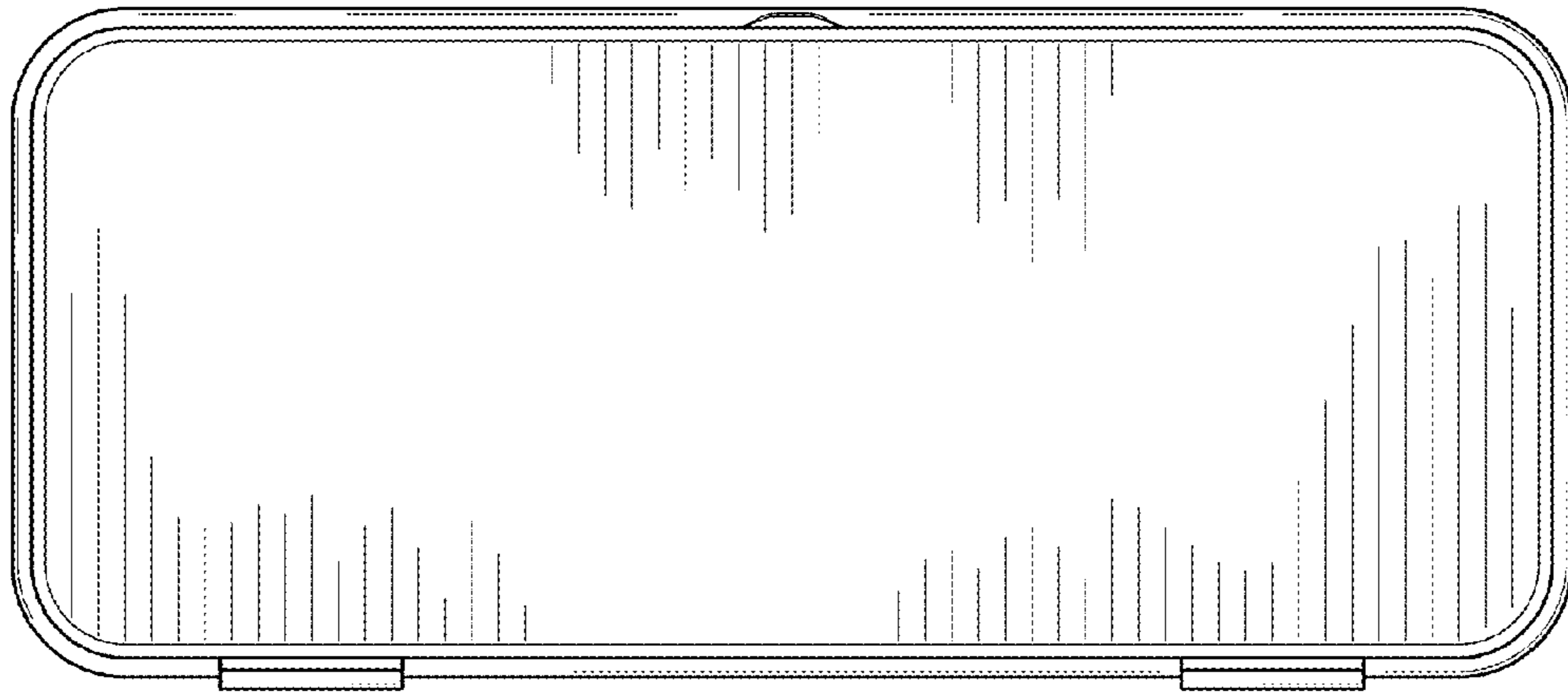

FIG. 6

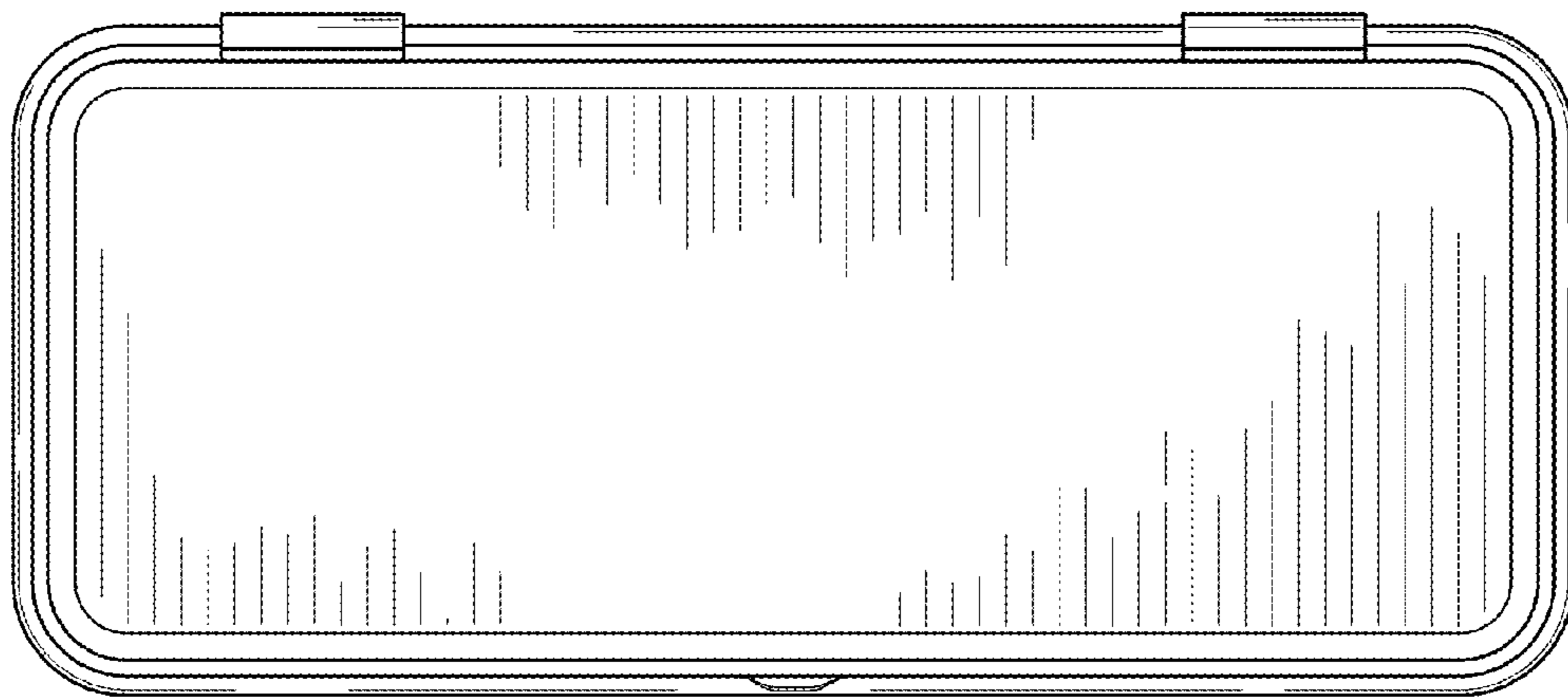

FIG. 7

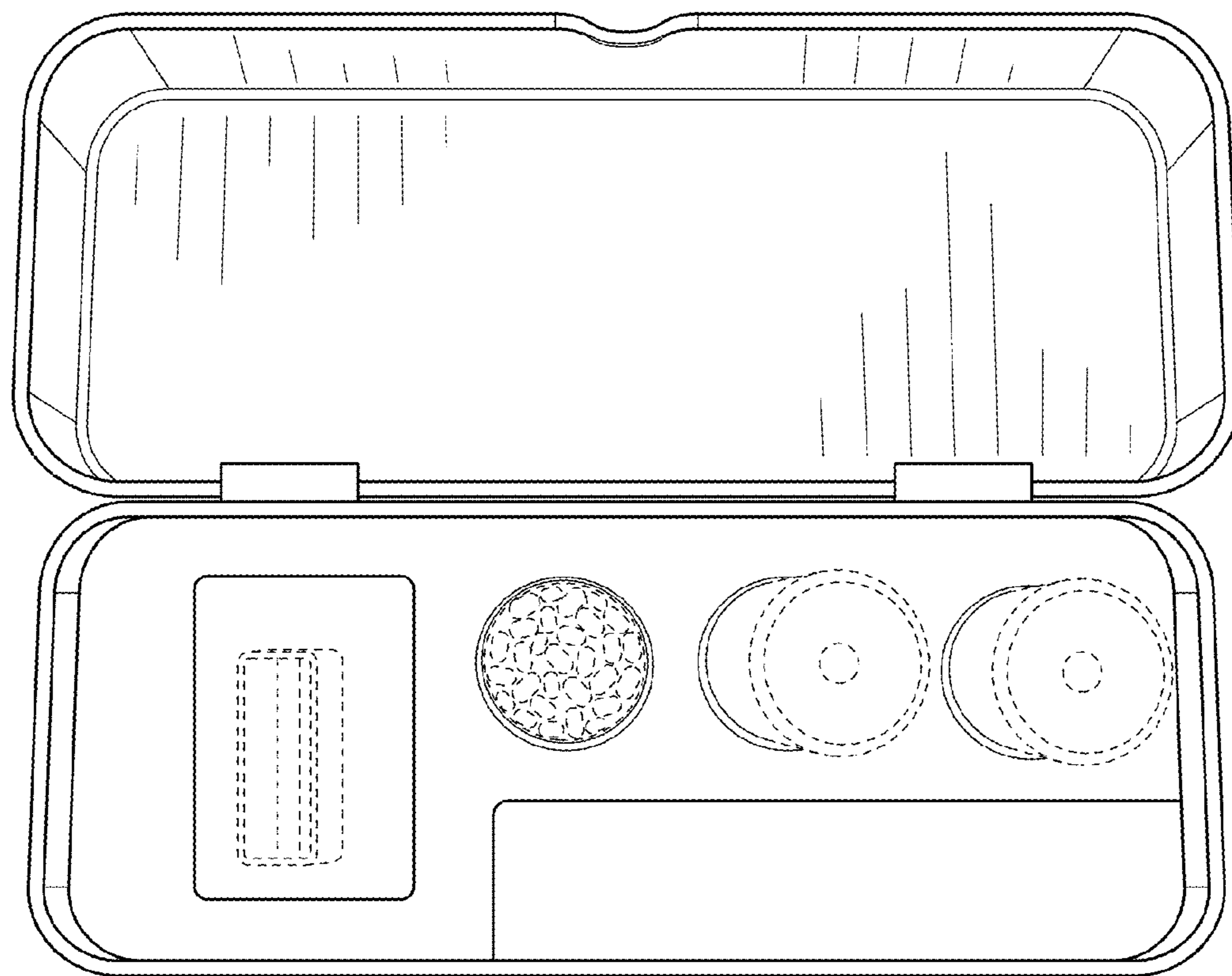

FIG. 8

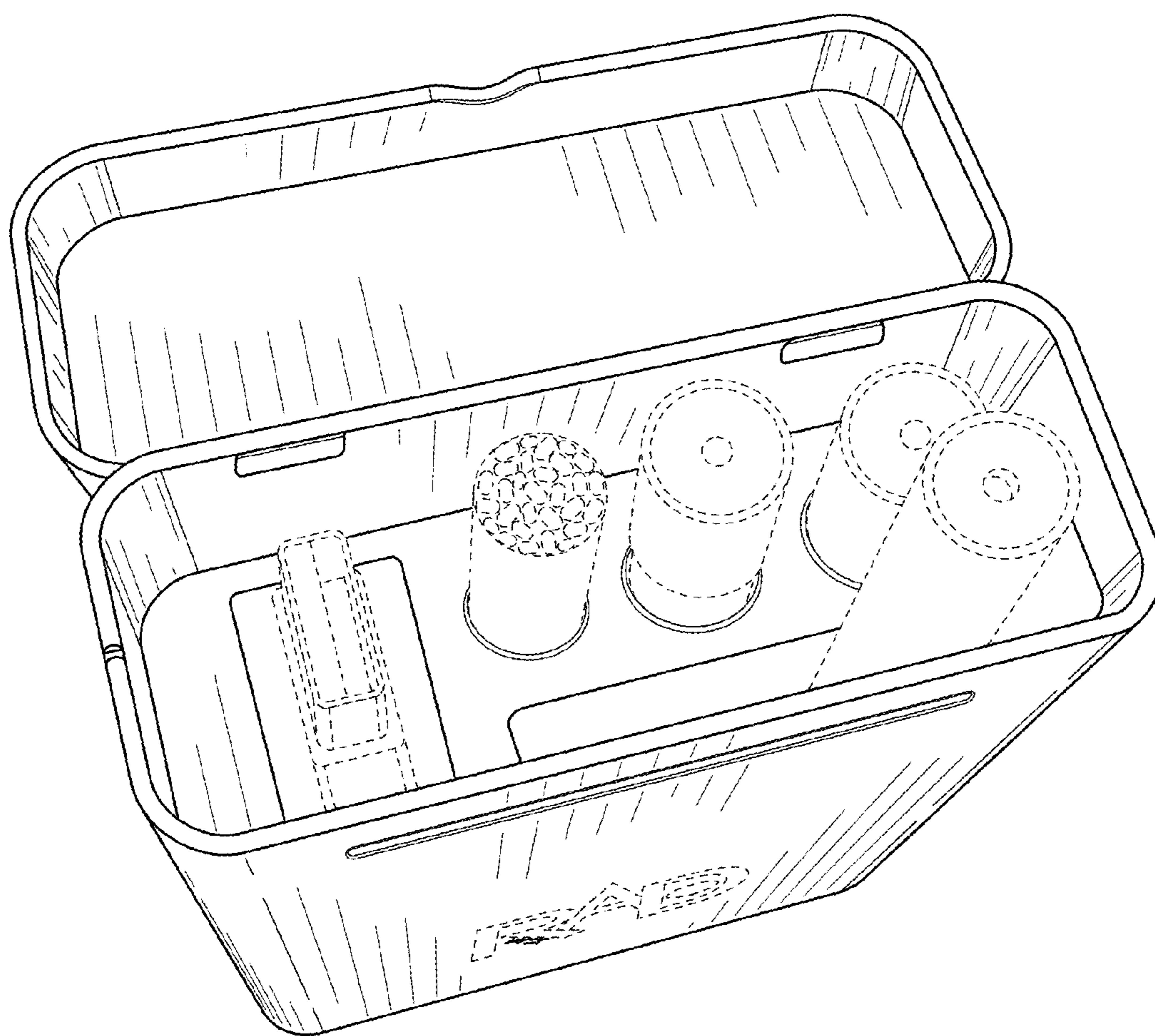

FIG. 9



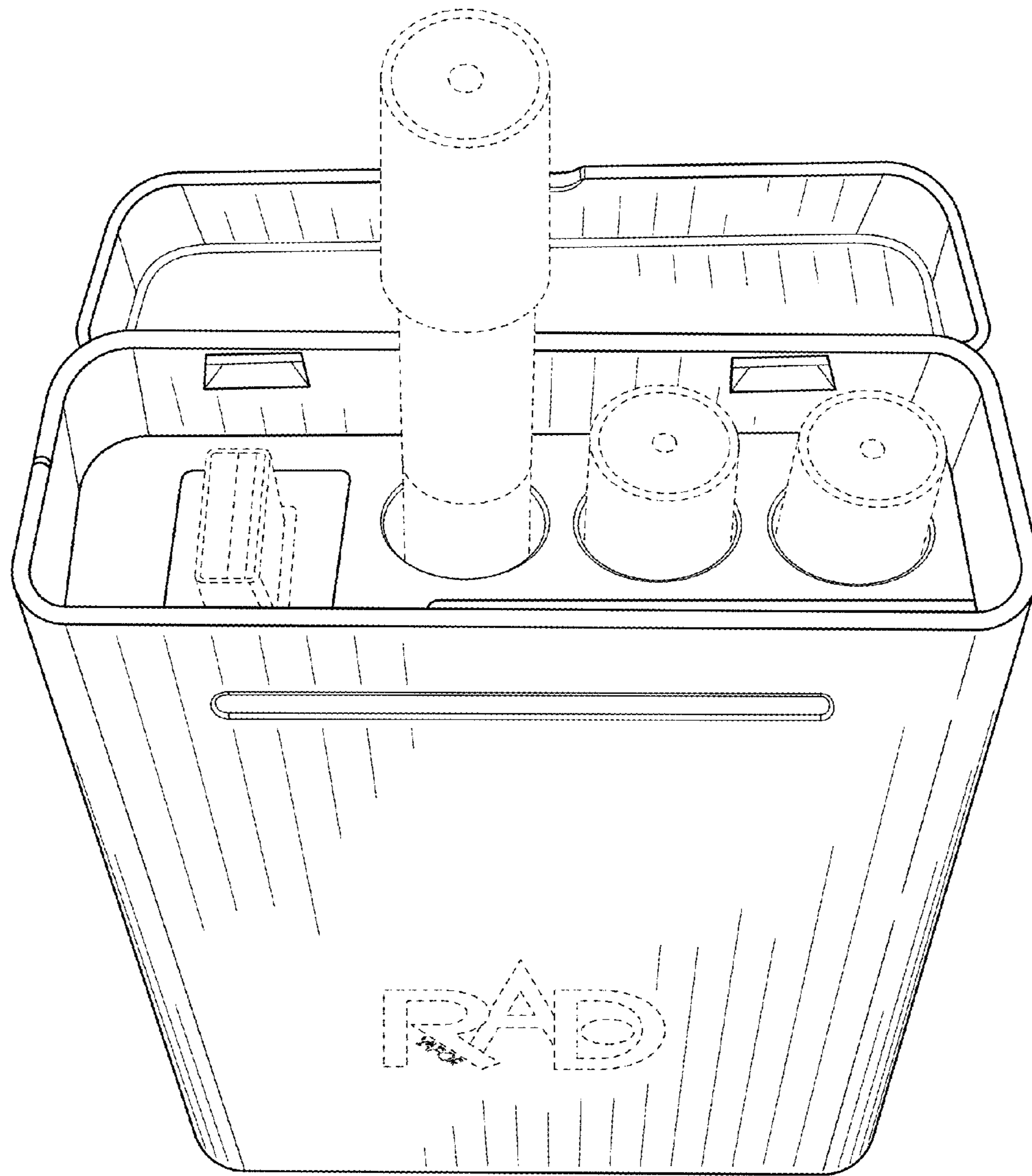

FIG. 10