



US00D718444S

(12) **United States Design Patent**
Yoshida et al.

(10) **Patent No.:** **US D718,444 S**

(45) **Date of Patent:** **** Nov. 25, 2014**

(54) **OPERATING GRIP FOR ENDOSCOPE**

(71) Applicant: **FUJIFILM Corporation**, Minato-ku,
Tokyo (JP)

(72) Inventors: **Koji Yoshida**, Ashigarakami-gun (JP);
Kunihiko Tanaka, Ashigarakami-gun
(JP)

(73) Assignee: **FUJIFILM Corporation**, Tokyo (JP)

(**) Term: **14 Years**

(21) Appl. No.: **29/448,251**

(22) Filed: **Mar. 11, 2013**

(30) **Foreign Application Priority Data**

Sep. 12, 2012 (JP) 2012-022110

(51) **LOC (10) Cl.** **24-02**

(52) **U.S. Cl.**
USPC **D24/138**

(58) **Field of Classification Search**

CPC .. A61B 1/00; A61B 1/00064; A61B 1/00066;
A61B 1/0669
USPC D24/138, 137, 133, 135, 140;
600/101-183

See application file for complete search history.

(56) **References Cited**

U.S. PATENT DOCUMENTS

D486,910	S	*	2/2004	Hayamizu et al.	D24/138
D493,529	S	*	7/2004	Hayamizu et al.	D24/138
D498,846	S	*	11/2004	Hayamizu et al.	D24/138
D638,937	S	*	5/2011	Tanaka	D24/138
D648,023	S	*	11/2011	Nohara et al.	D24/138
D649,244	S	*	11/2011	Nohara et al.	D24/138
D668,762	S	*	10/2012	Makowski et al.	D24/138
D669,174	S	*	10/2012	Makowski et al.	D24/138
D669,175	S	*	10/2012	Makowski et al.	D24/138
2013/0012780	A1	*	1/2013	Nakamura et al.	600/122
2014/0187864	A1	*	7/2014	Kubo	600/139

* cited by examiner

Primary Examiner — Bridget L Eland

(74) *Attorney, Agent, or Firm* — Sughrue Mion, PLLC

(57) **CLAIM**

The ornamental design for an operating grip for endoscope, as shown and described.

DESCRIPTION

FIG. 1 is a top, rear and side perspective view of an operating grip for endoscope showing our new design; FIG. 2 is a front elevational view thereof; FIG. 3 is a rear elevational view thereof; FIG. 4 is a top plan view thereof; FIG. 5 is a bottom plan view thereof; FIG. 6 is a left side elevational view thereof; and, FIG. 7 is a right side elevational view thereof. The broken lines in the drawings are included for the purpose of illustrating portions of the operating grip for endoscope that form no part of the claimed design.

1 Claim, 7 Drawing Sheets

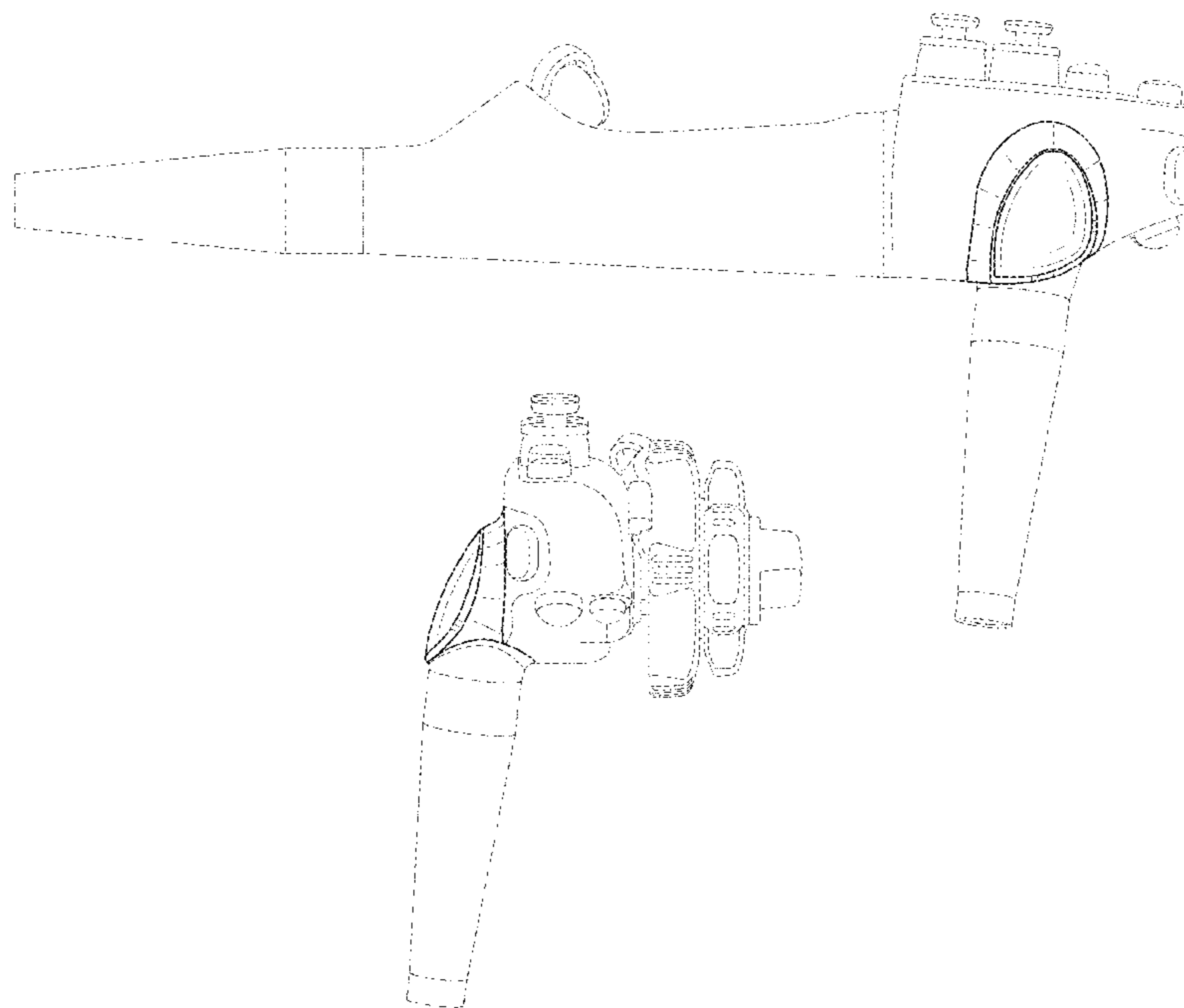

FIG.1

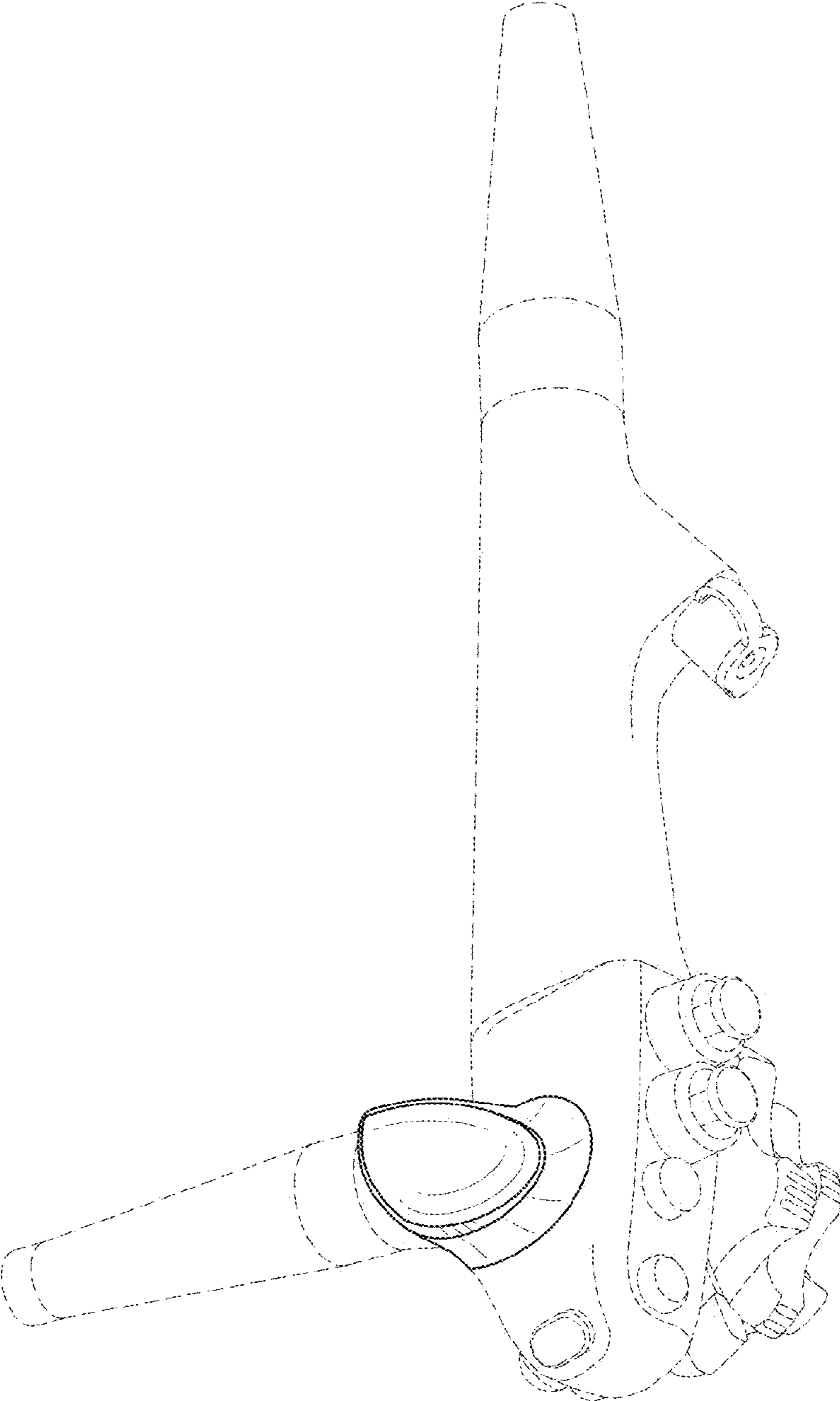

FIG. 2

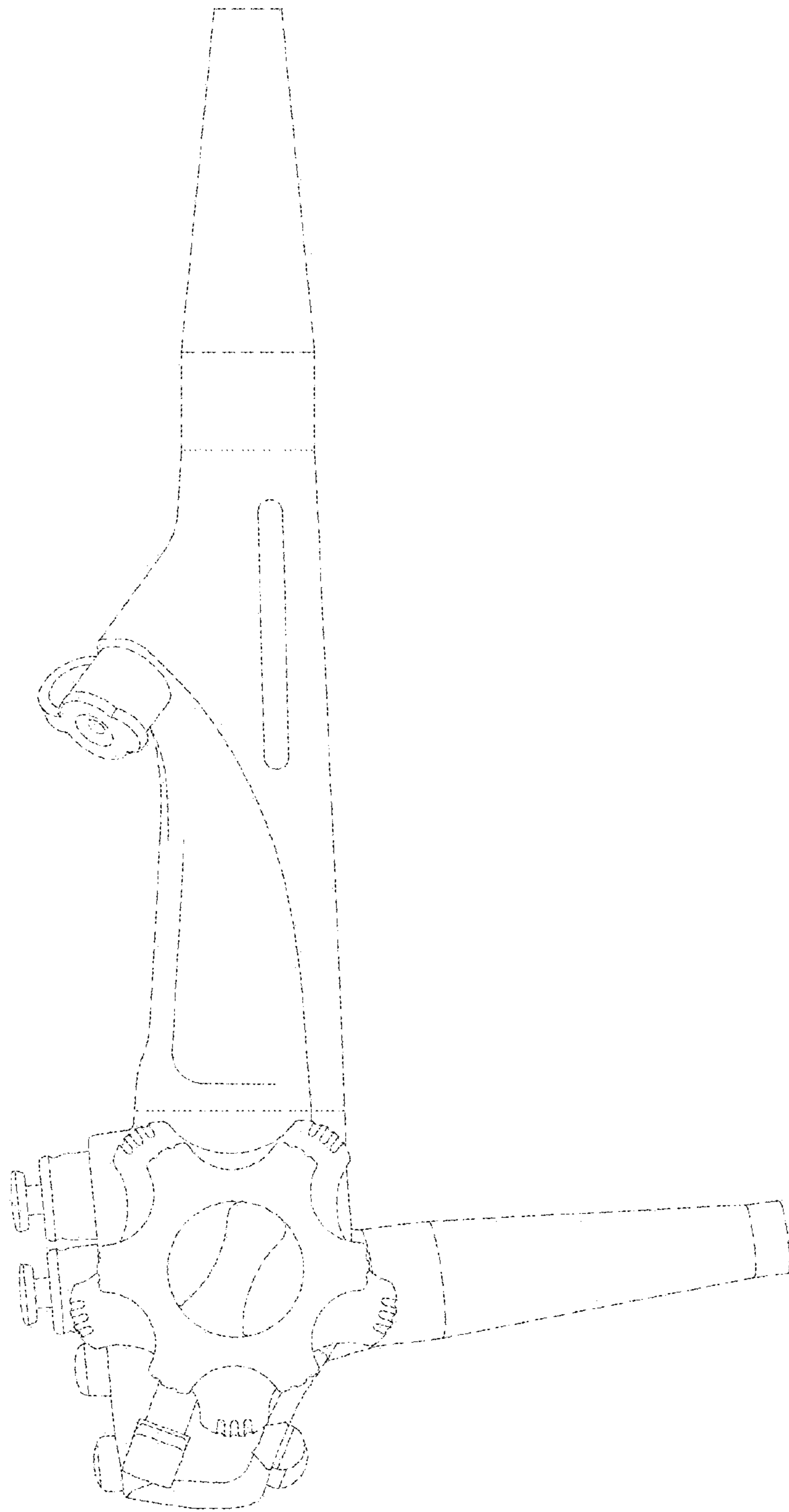

FIG. 3

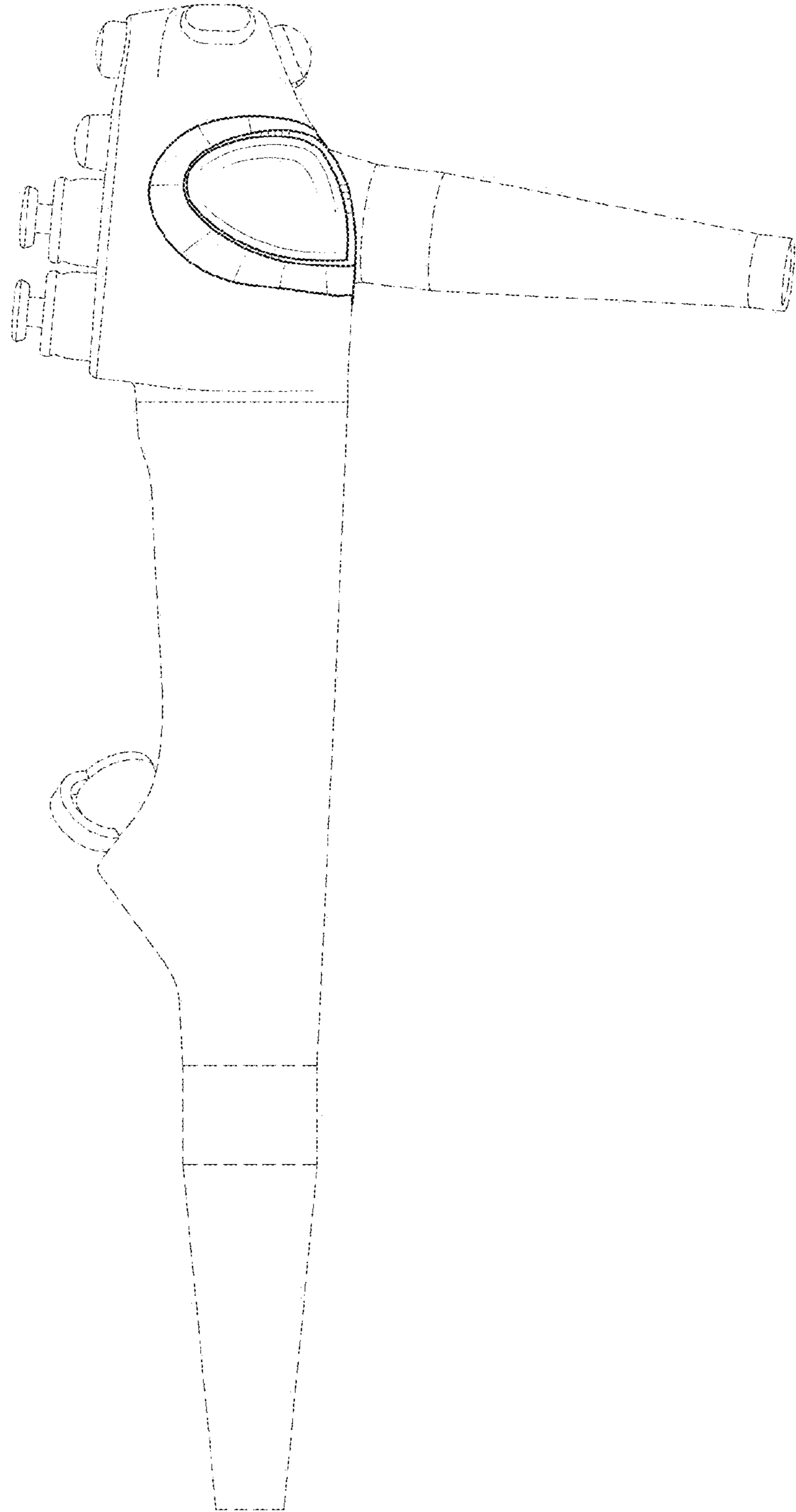

FIG. 4

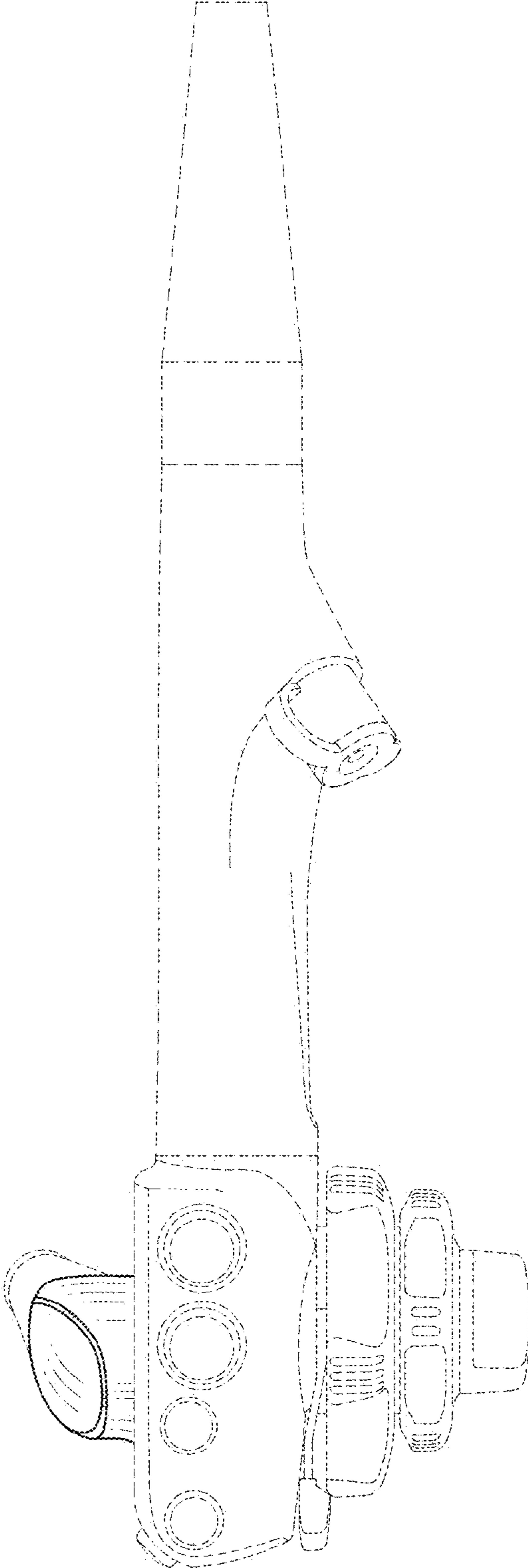

FIG. 5

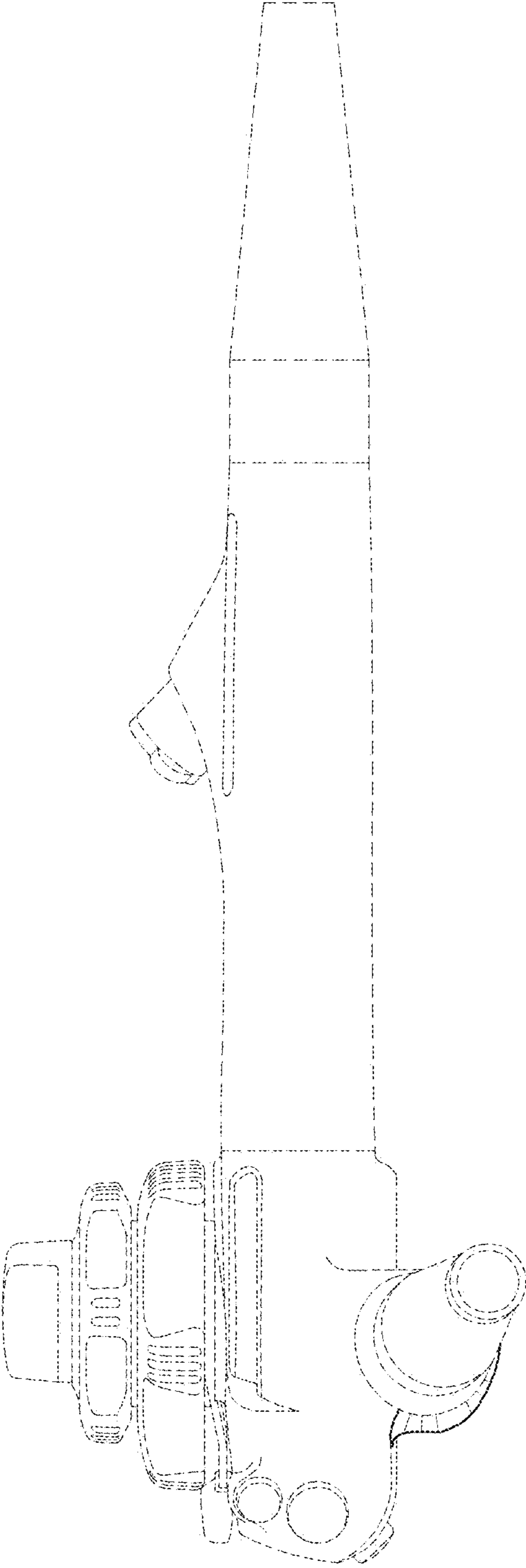

FIG. 6

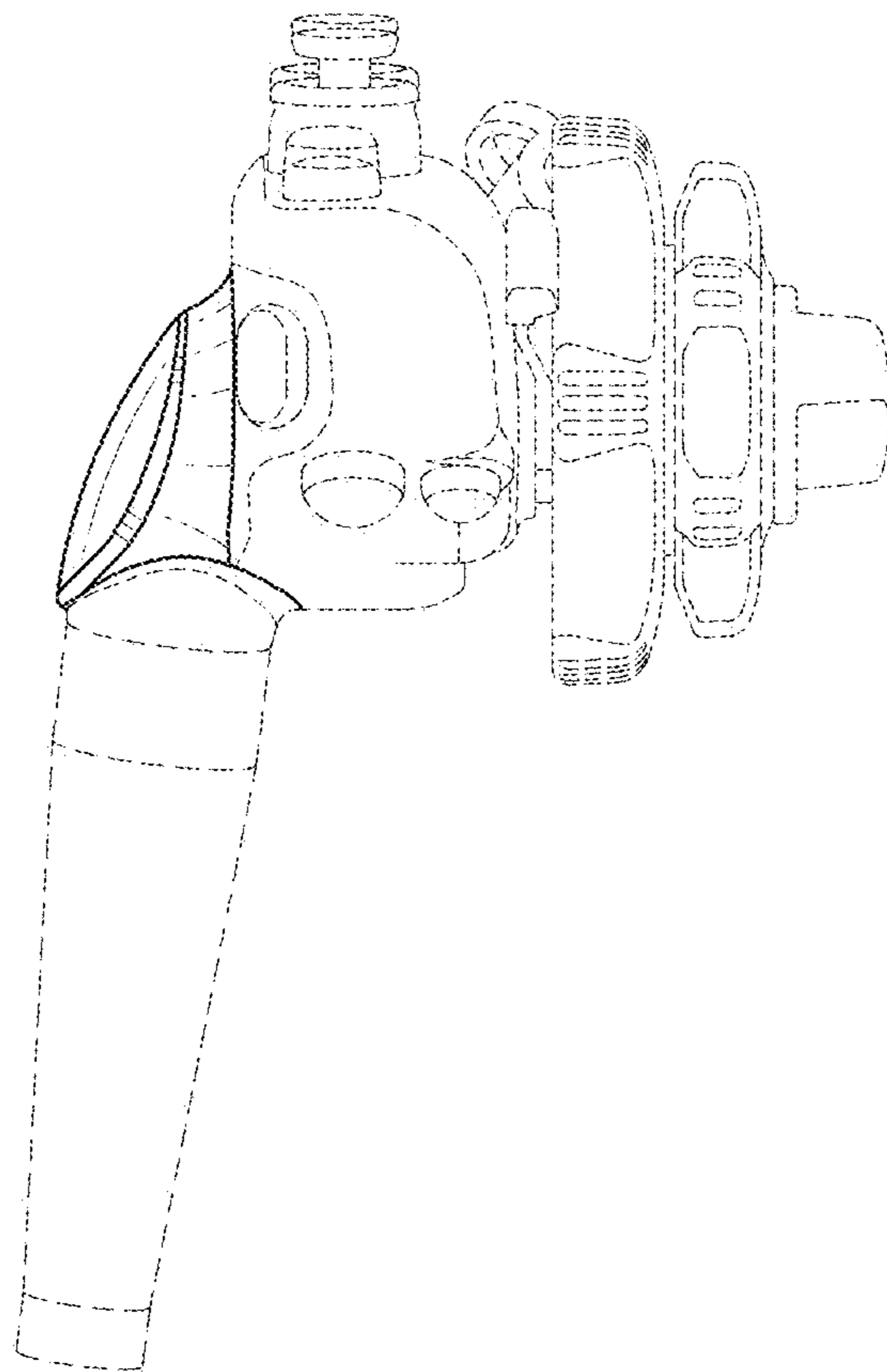

FIG. 7

