



US00D718273S

(12) **United States Design Patent**  
**Harata et al.**

(10) **Patent No.:** **US D718,273 S**  
(45) **Date of Patent:** **\*\* Nov. 25, 2014**

(54) **REMOTE CONTROL FOR EARPHONE**

(71) Applicant: **Samsung Electronics Co., Ltd.**,  
Suwon-si (KR)

(72) Inventors: **Tomohiro Harata**, Seoul (KR);  
**Hyun-Keun Son**, Seoul (KR)

(73) Assignee: **Samsung Electronics Co., Ltd.** (KR)

(\*\*) Term: **14 Years**

(21) Appl. No.: **29/467,050**

(22) Filed: **Sep. 13, 2013**

(30) **Foreign Application Priority Data**

Mar. 14, 2013 (KR) ..... 30-2013-0013124

(51) **LOC (10) Cl.** ..... **14-01**

(52) **U.S. Cl.**  
USPC ..... **D14/205**; D14/218

(58) **Field of Classification Search**  
CPC ..... H04R 25/558  
USPC ..... D14/205, 218, 188, 192, 217, 225, 240;  
D13/168, 169, 173; D16/237;  
D21/566; D10/104.1; 379/428.01,  
379/433.01-433.04, 420.01-420.04;  
340/12.22, 426.13; 348/734; 381/380,  
381/381; 455/352, 355  
See application file for complete search history.

(56) **References Cited**

**U.S. PATENT DOCUMENTS**

D220,723 S \* 5/1971 Abbo ..... D14/197  
D322,609 S \* 12/1991 Patton ..... D14/218  
D326,655 S \* 6/1992 Iribe ..... D14/192  
D344,524 S \* 2/1994 Taniguchi ..... D14/218  
5,481,251 A \* 1/1996 Buys et al. .... 340/12.22

D392,979 S \* 3/1998 Inukai ..... D14/228  
D411,998 S \* 7/1999 Hakoda et al. .... D14/218  
D417,869 S \* 12/1999 Yasutomi ..... D14/168  
D450,337 S \* 11/2001 Hamamura ..... D16/237  
D472,885 S \* 4/2003 Kataoka ..... D14/167  
D578,508 S \* 10/2008 Wang ..... D14/206  
D593,999 S \* 6/2009 Mauritzsson ..... D14/225  
D597,071 S \* 7/2009 Andre et al. .... D14/206  
D603,837 S \* 11/2009 Martin ..... D14/206  
D614,166 S \* 4/2010 Brickstad ..... D14/205  
D614,168 S \* 4/2010 Rogers et al. .... D14/206  
D614,604 S \* 4/2010 Hoehn et al. .... D14/218  
D624,058 S \* 9/2010 Kolton ..... D14/225  
D646,232 S \* 10/2011 Felegy et al. .... D13/168  
D681,001 S \* 4/2013 Murchison et al. .... D14/205  
D685,750 S \* 7/2013 Nakagawa ..... D13/168

\* cited by examiner

*Primary Examiner* — Paula Greene

(74) *Attorney, Agent, or Firm* — Cantor Colburn LLP

(57) **CLAIM**

The ornamental design for a remote control for earphone, as shown and described.

**DESCRIPTION**

FIG. 1 is a top front perspective view of a remote control for earphone showing our new design;  
FIG. 2 is a front view thereof;  
FIG. 3 is a rear view thereof  
FIG. 4 is a left side view thereof;  
FIG. 5 is a right side view thereof;  
FIG. 6 is a top view thereof;  
FIG. 7 is a bottom view thereof; and,  
FIG. 8 is another front view thereof, as shown in a user environment.

The broken lines illustrating portions of the remote control for earphone are for environmental purposes only and form no part of the claimed design.

**1 Claim, 3 Drawing Sheets**

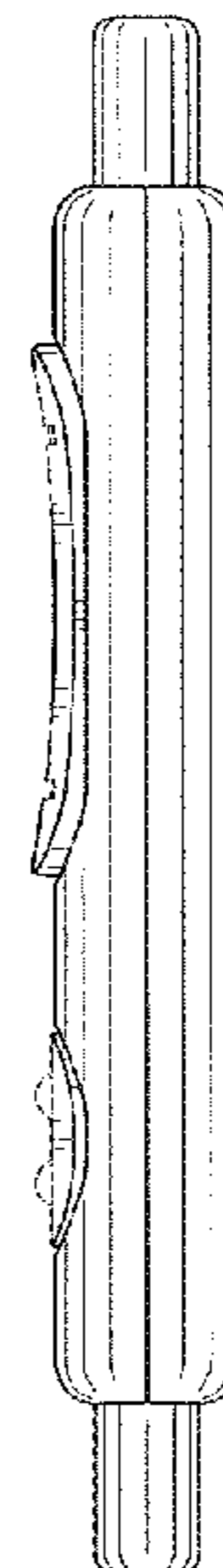
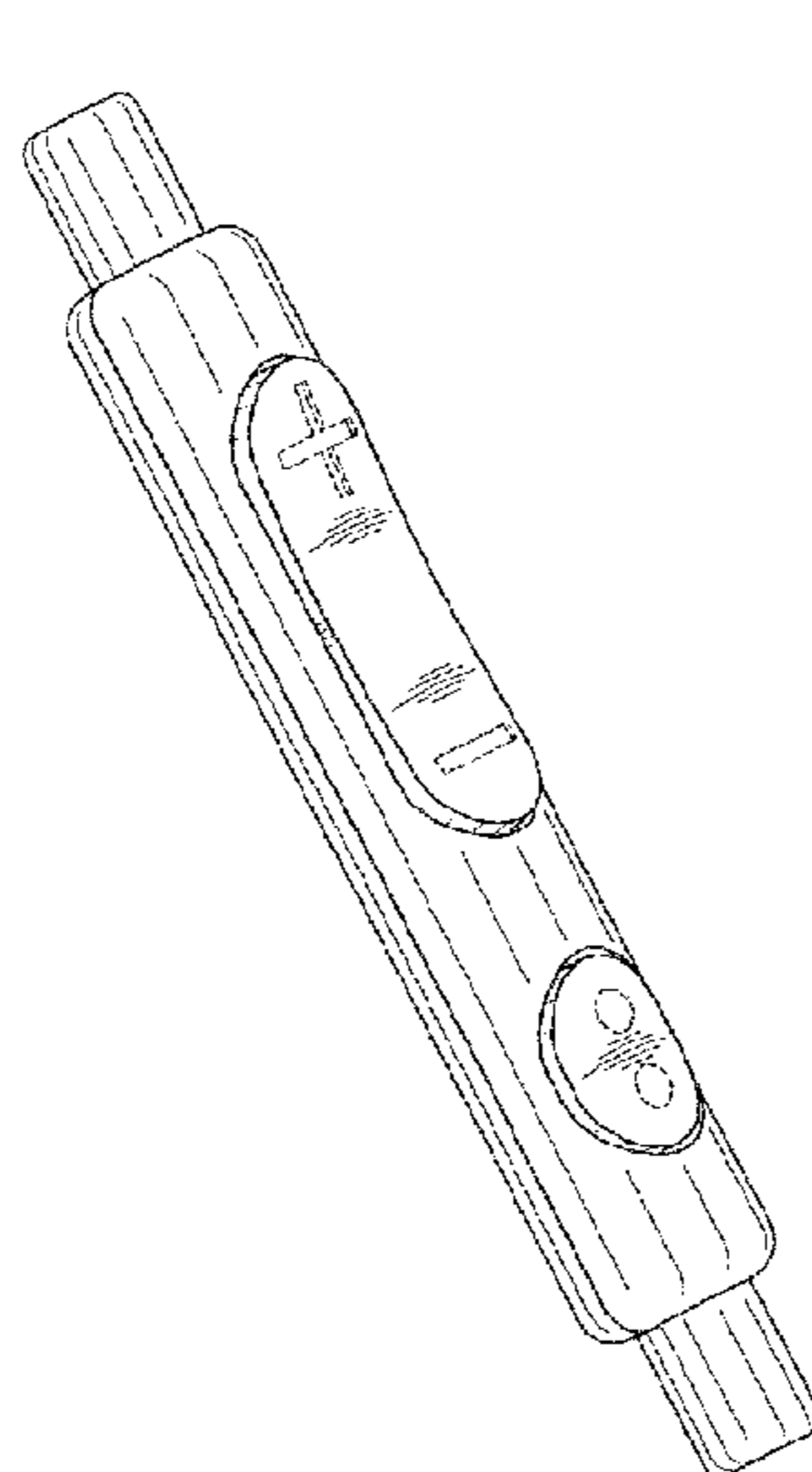

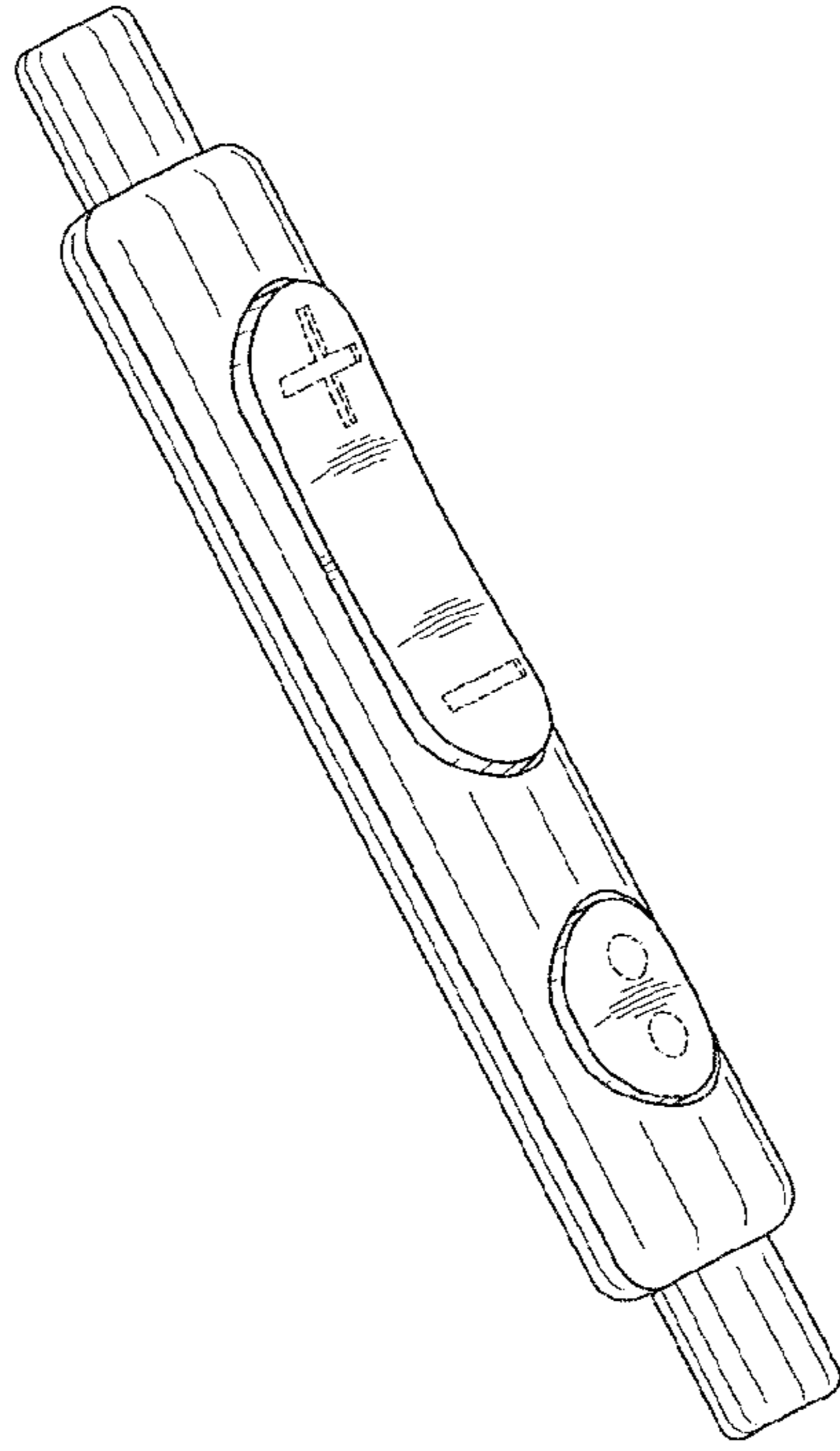

FIG.1

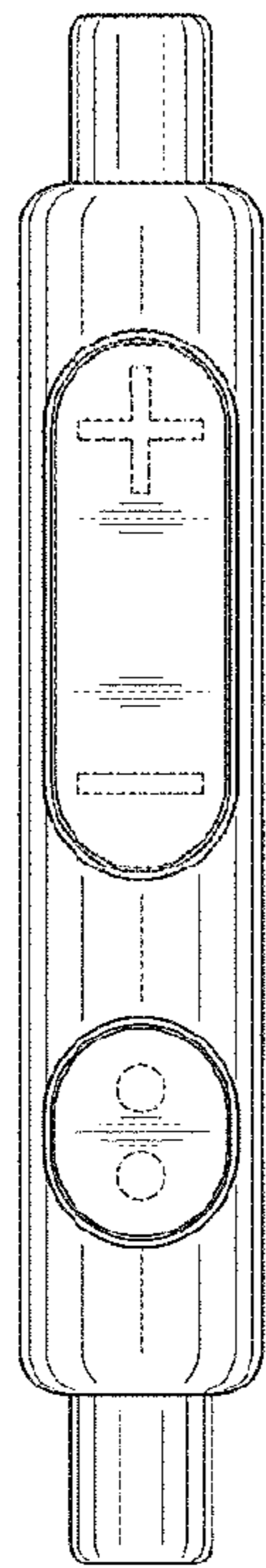

FIG. 2

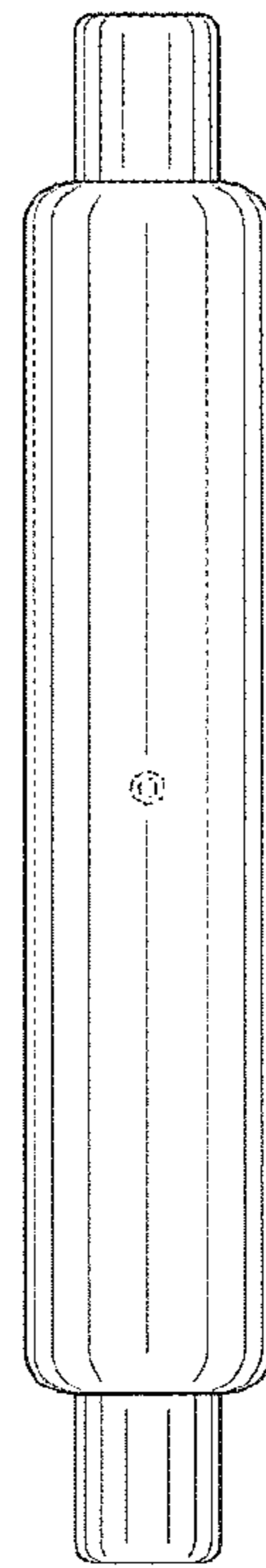

FIG. 3

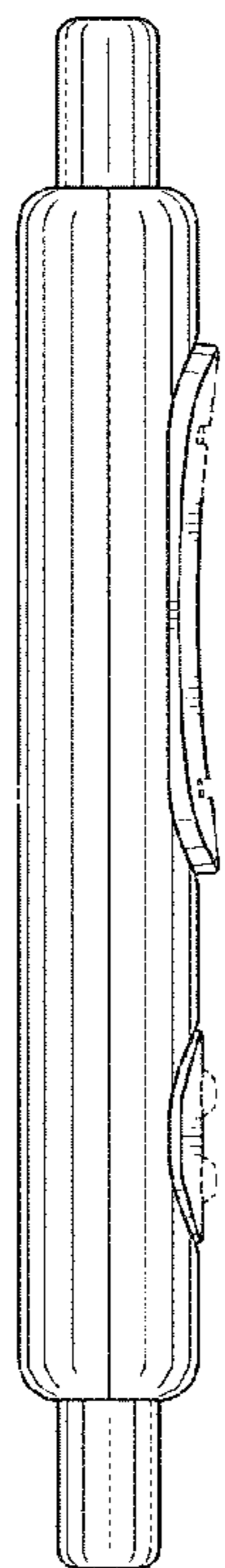

FIG. 4

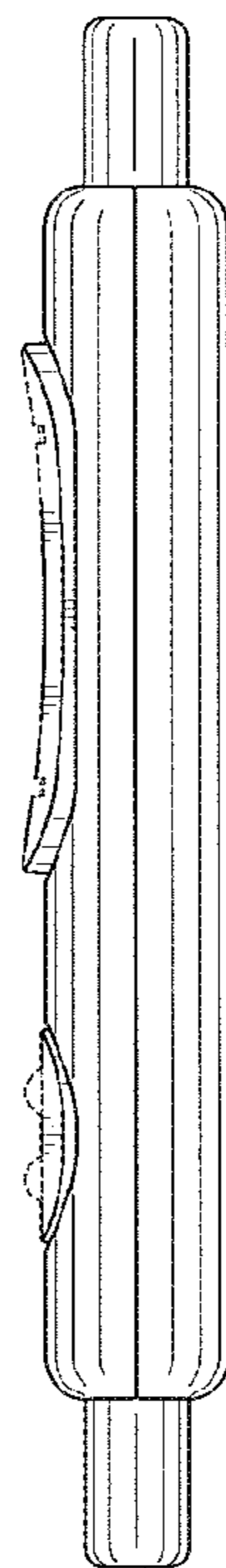

FIG. 5

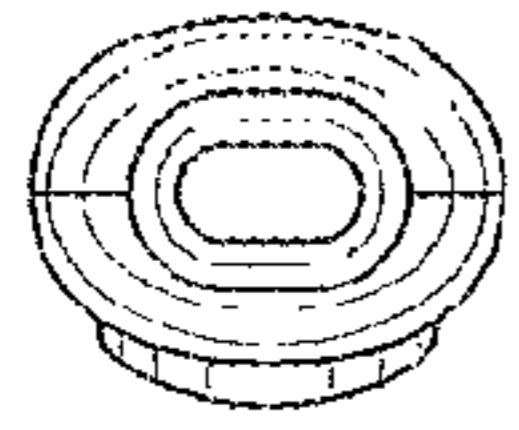

FIG. 6

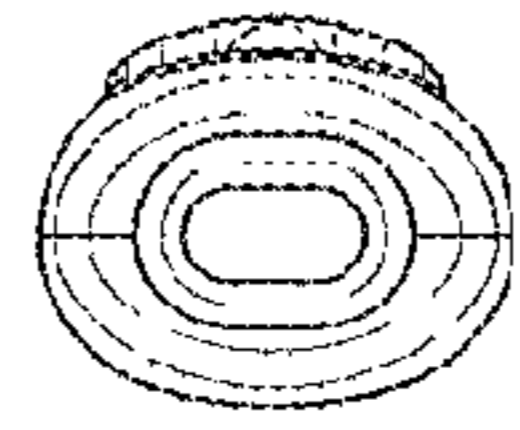

FIG. 7



FIG. 8