



US00D718235S

(12) **United States Design Patent**
Uzuyama

(10) **Patent No.:** **US D718,235 S**

(45) **Date of Patent:** **** Nov. 25, 2014**

(54) **MOBILE PHONE CHARGER**

(71) Applicant: **Panasonic Corporation**, Kadoma-shi,
Osaka (JP)

(72) Inventor: **Daijiro Uzuyama**, Kanagawa (JP)

(73) Assignee: **Panasonic Corporation**, Osaka (JP)

(**) Term: **14 Years**

(21) Appl. No.: **29/487,931**

(22) Filed: **Apr. 14, 2014**

(30) **Foreign Application Priority Data**

Oct. 16, 2013 (JP) 2013-023994
Oct. 16, 2013 (JP) 2013-023995

(51) **LOC (10) Cl.** **13-02**

(52) **U.S. Cl.**
USPC **D13/108**

(58) **Field of Classification Search**
USPC D13/107–110, 118–119, 184, 199;
D14/251, 253, 432, 434; 320/107–115,
320/128, 137–140
See application file for complete search history.

(56) **References Cited**

U.S. PATENT DOCUMENTS

D321,855 S * 11/1991 Ross, Jr. D13/107
5,357,185 A * 10/1994 Chen 320/110
D382,537 S * 8/1997 Brunette D13/119
D385,530 S * 10/1997 Hames et al. D13/107
D462,657 S * 9/2002 Kaneko D13/107
D532,369 S * 11/2006 Shimizu D13/108
D532,370 S * 11/2006 Shimizu D13/108
D558,667 S * 1/2008 Park et al. D13/108
7,531,985 B2 * 5/2009 Kim 320/112

8,344,693 B2 * 1/2013 Budziszek et al. 320/114
D680,118 S * 4/2013 Schmelling D14/434
D693,815 S * 11/2013 Son D14/434
2010/0109605 A1 * 5/2010 Nakasho et al. 320/113

* cited by examiner

Primary Examiner — Rosemary K Tarcza

(74) *Attorney, Agent, or Firm* — Brinks Gilson & Lione

(57) **CLAIM**

I claim the ornamental design for a mobile phone charger, as shown and described.

DESCRIPTION

FIG. 1 is a top perspective view of a first embodiment of a mobile phone charger of the present invention; FIG. 2 is a front view thereof; FIG. 3 is a first side view thereof; FIG. 4 is a second side view thereof; FIG. 5 is a top view thereof; FIG. 6 is a bottom view thereof; FIG. 7 is a rear view thereof; FIG. 8 is a top perspective view of a second embodiment of a mobile phone charger of the present invention; FIG. 9 is a front view thereof; FIG. 10 is a first side view thereof; FIG. 11 is a second side view thereof; FIG. 12 is a top view thereof; FIG. 13 is a bottom view thereof; and, FIG. 14 is a rear view thereof.

The broken lines shown are for the purpose of illustrating unclaimed portions of the mobile phone charger and form no part of the claimed design. Additionally, the unevenly broken lines in the drawings define the boundaries of the claimed design, and form no part of the claimed design.

1 Claim, 14 Drawing Sheets

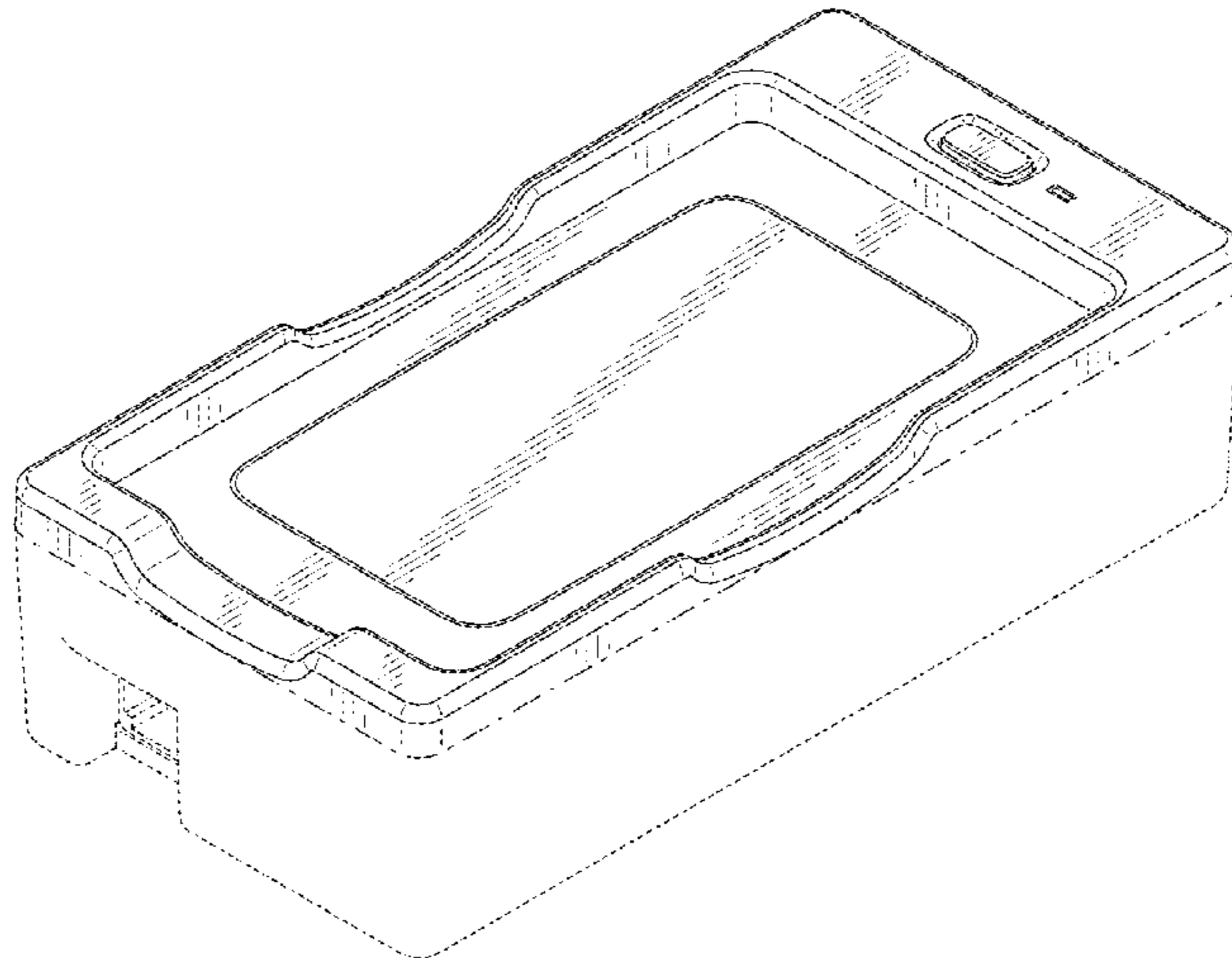

FIG. 1

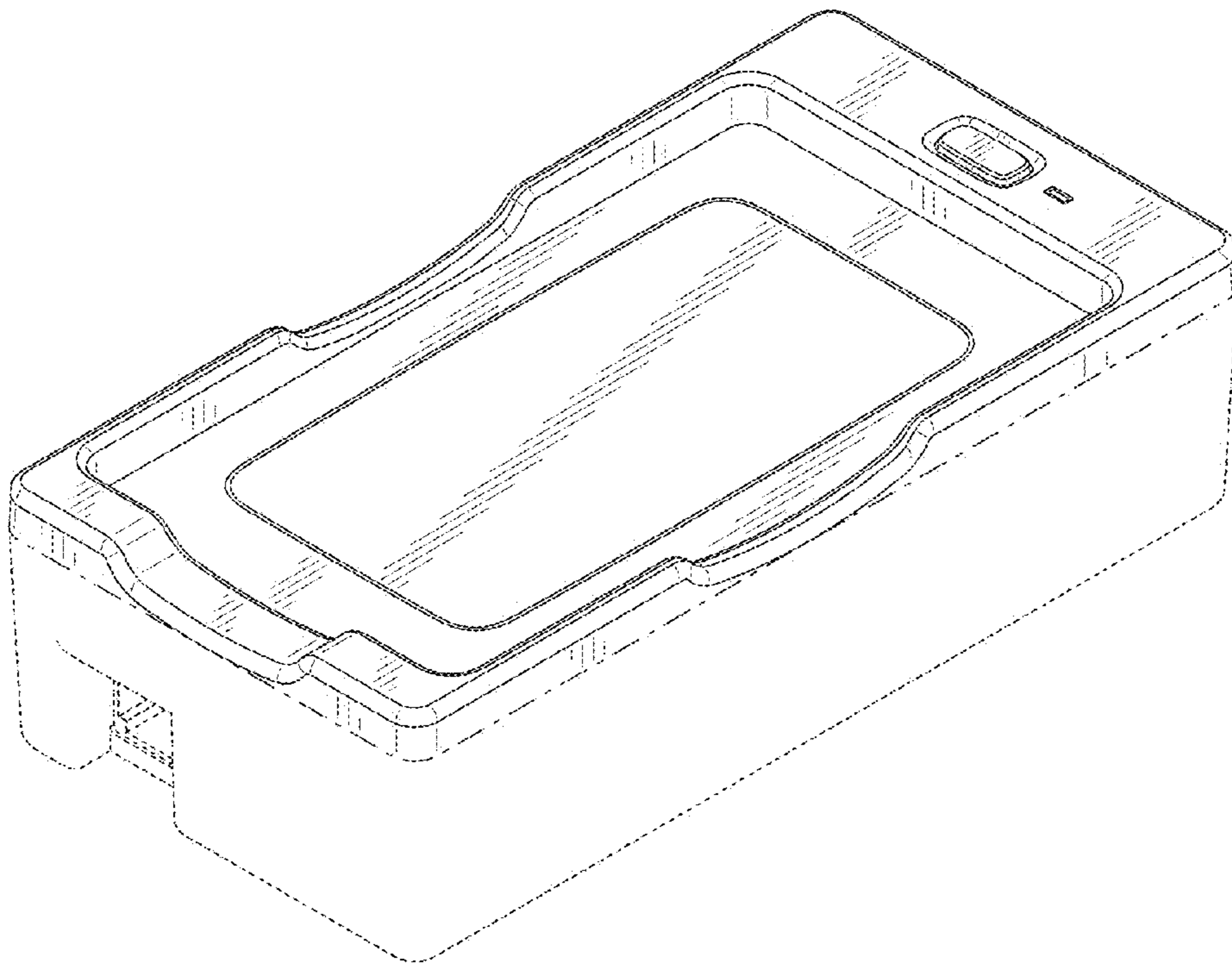

FIG.2

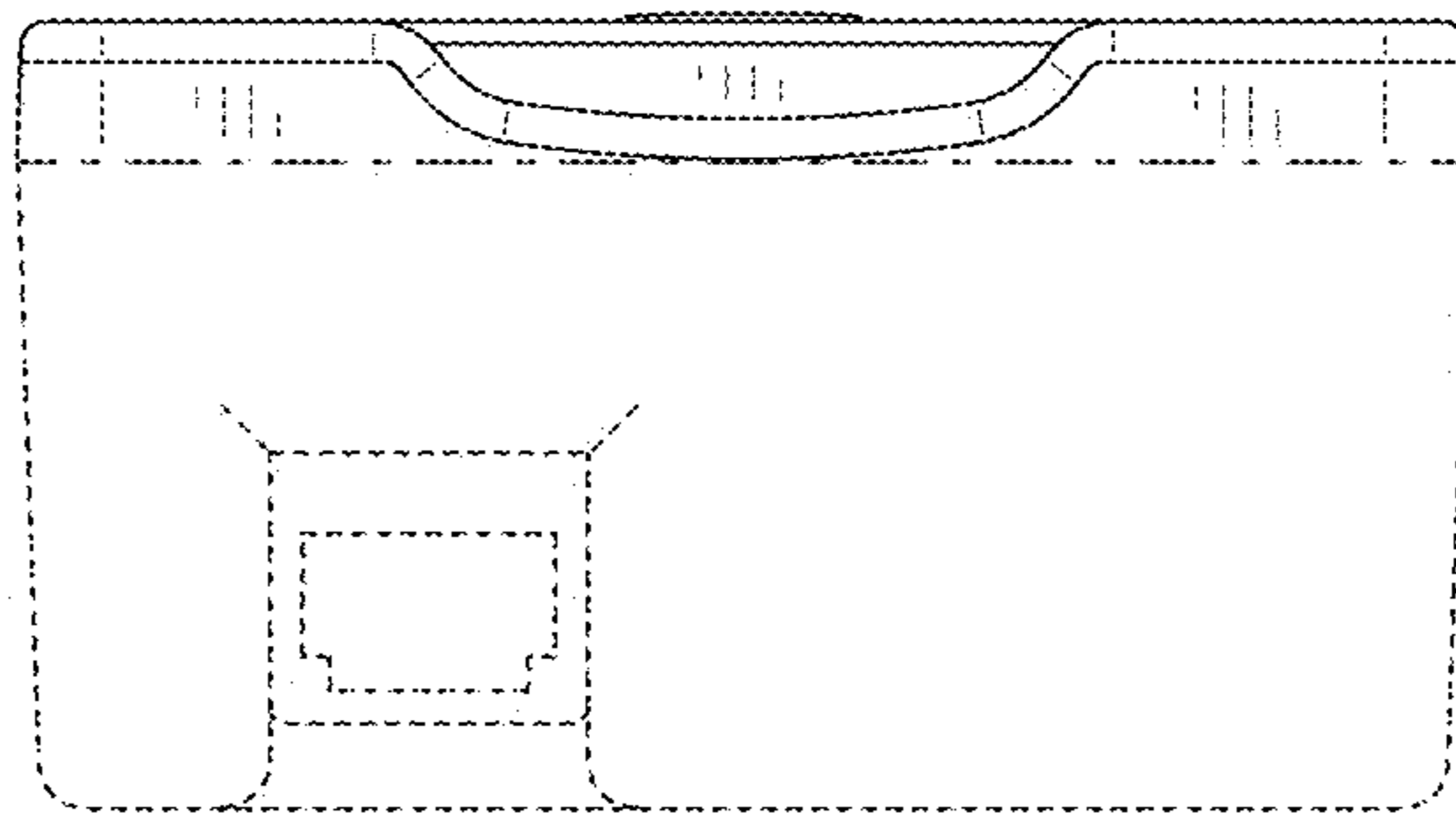

FIG.3

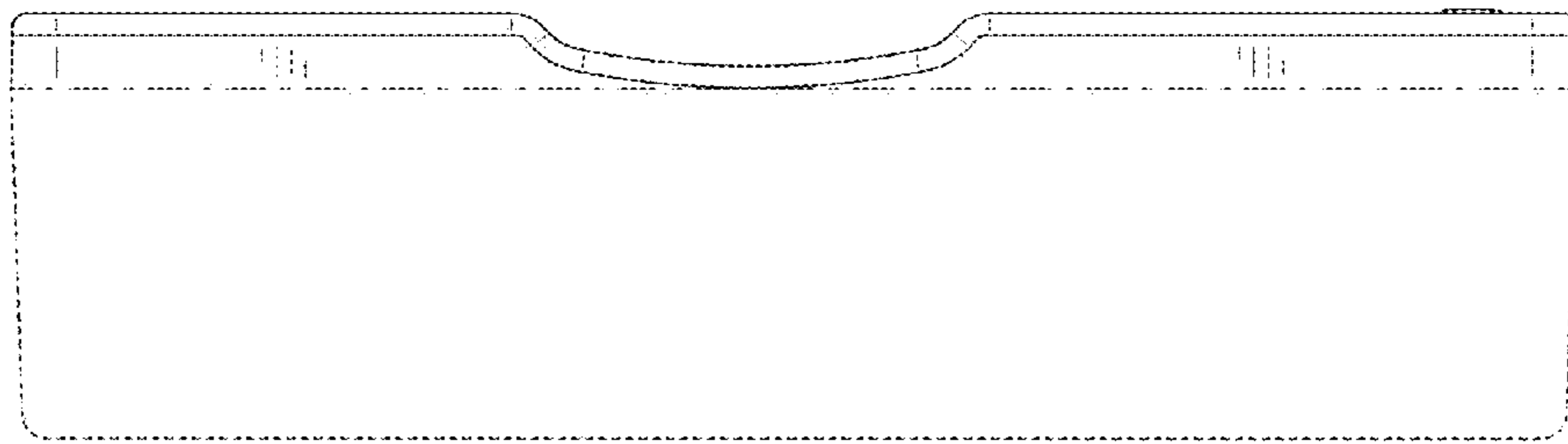

FIG.4

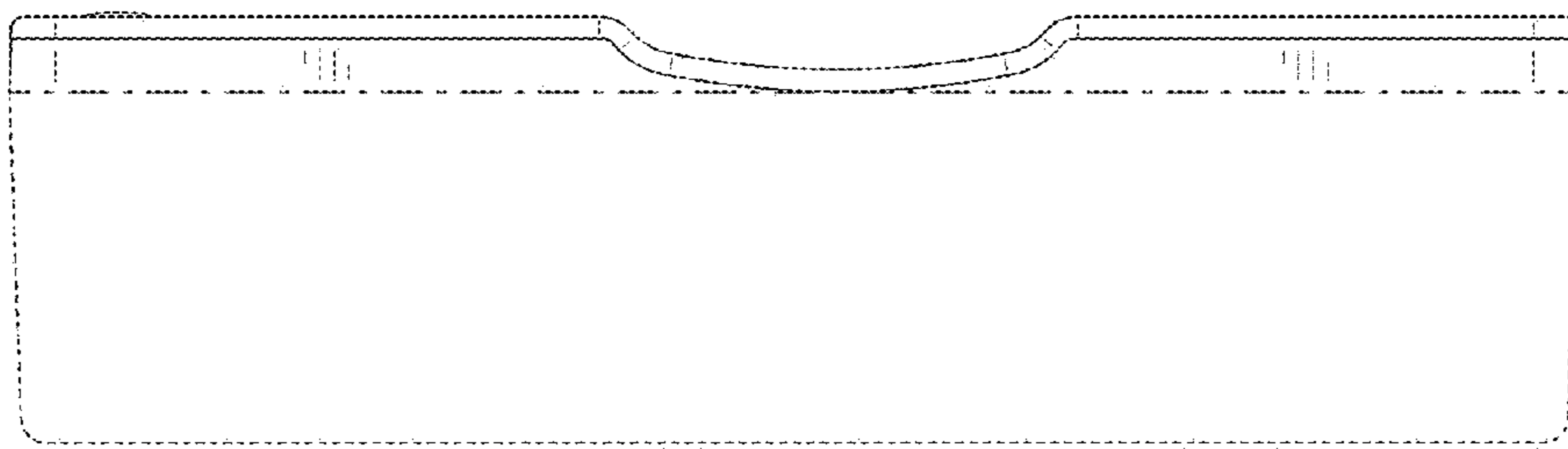

FIG.5

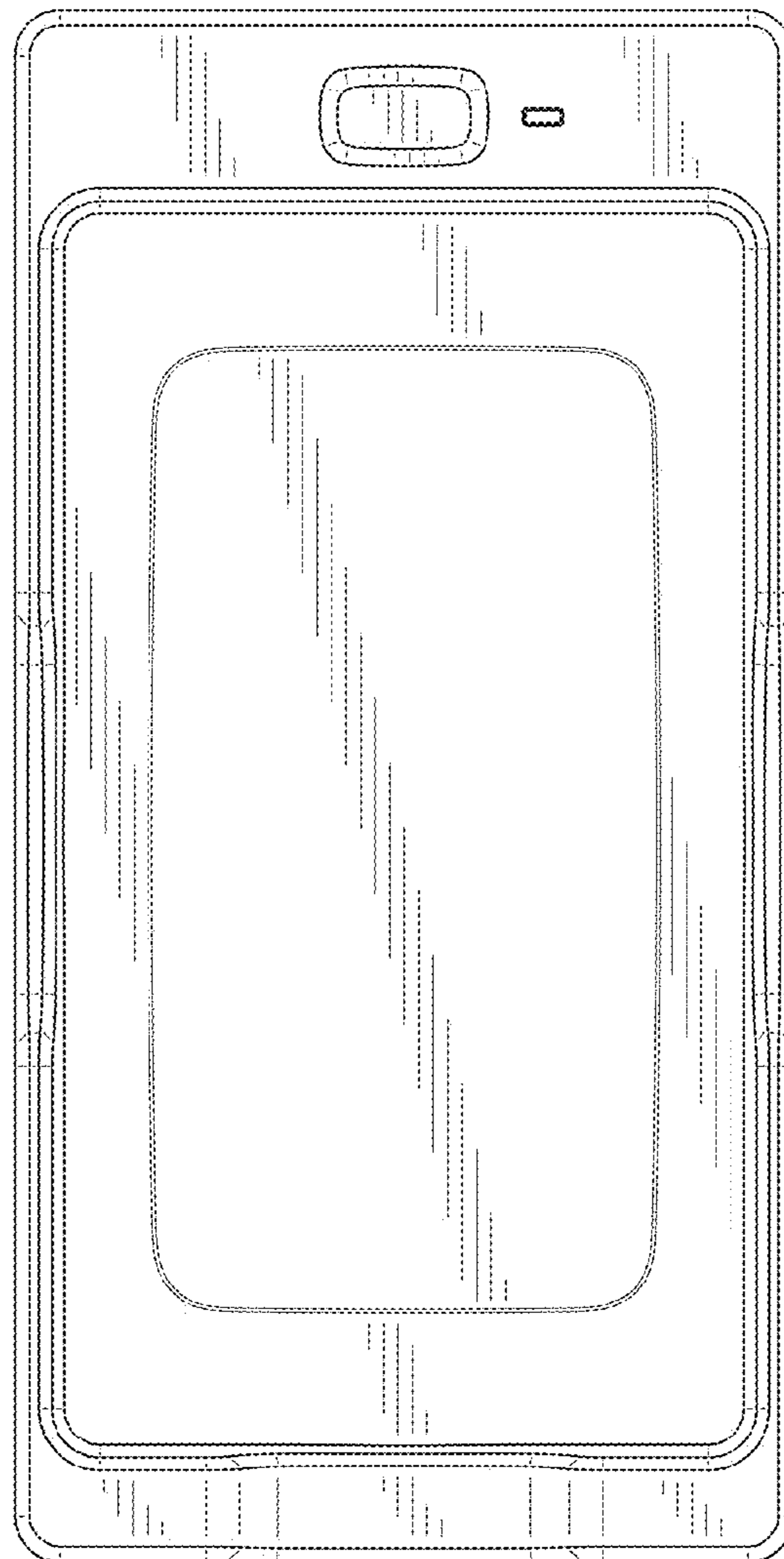

FIG.6

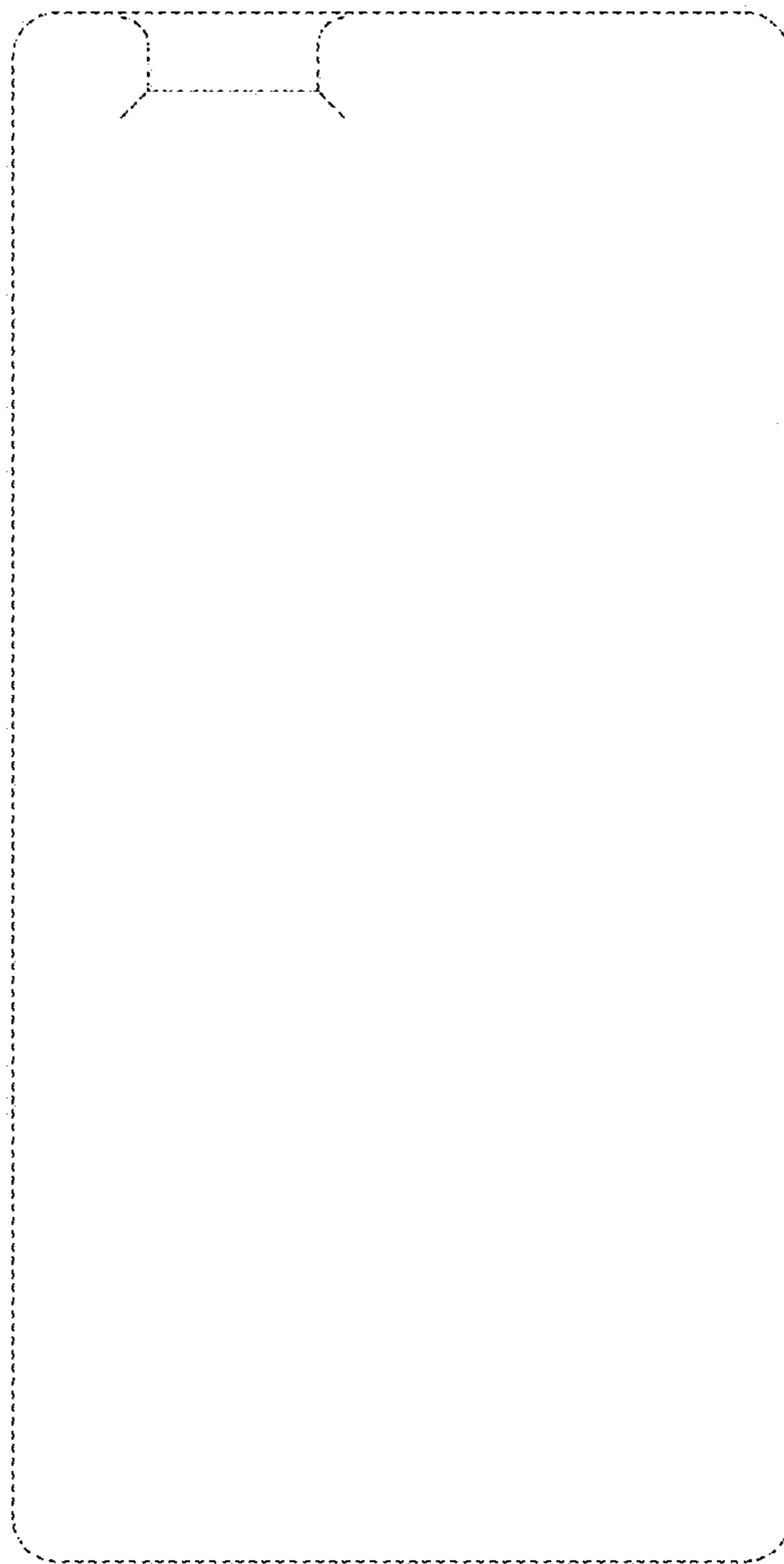

FIG. 7

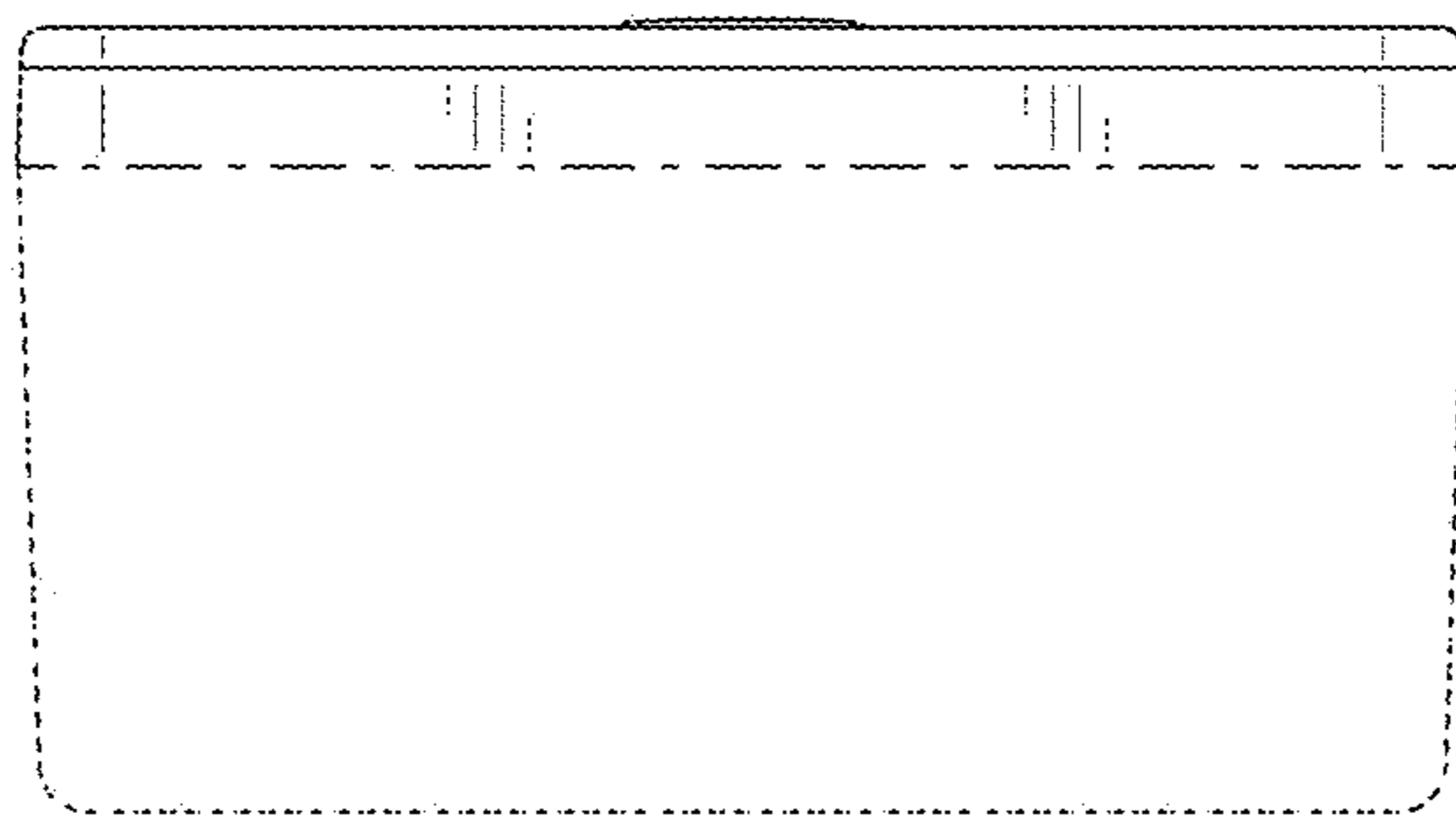

FIG.8

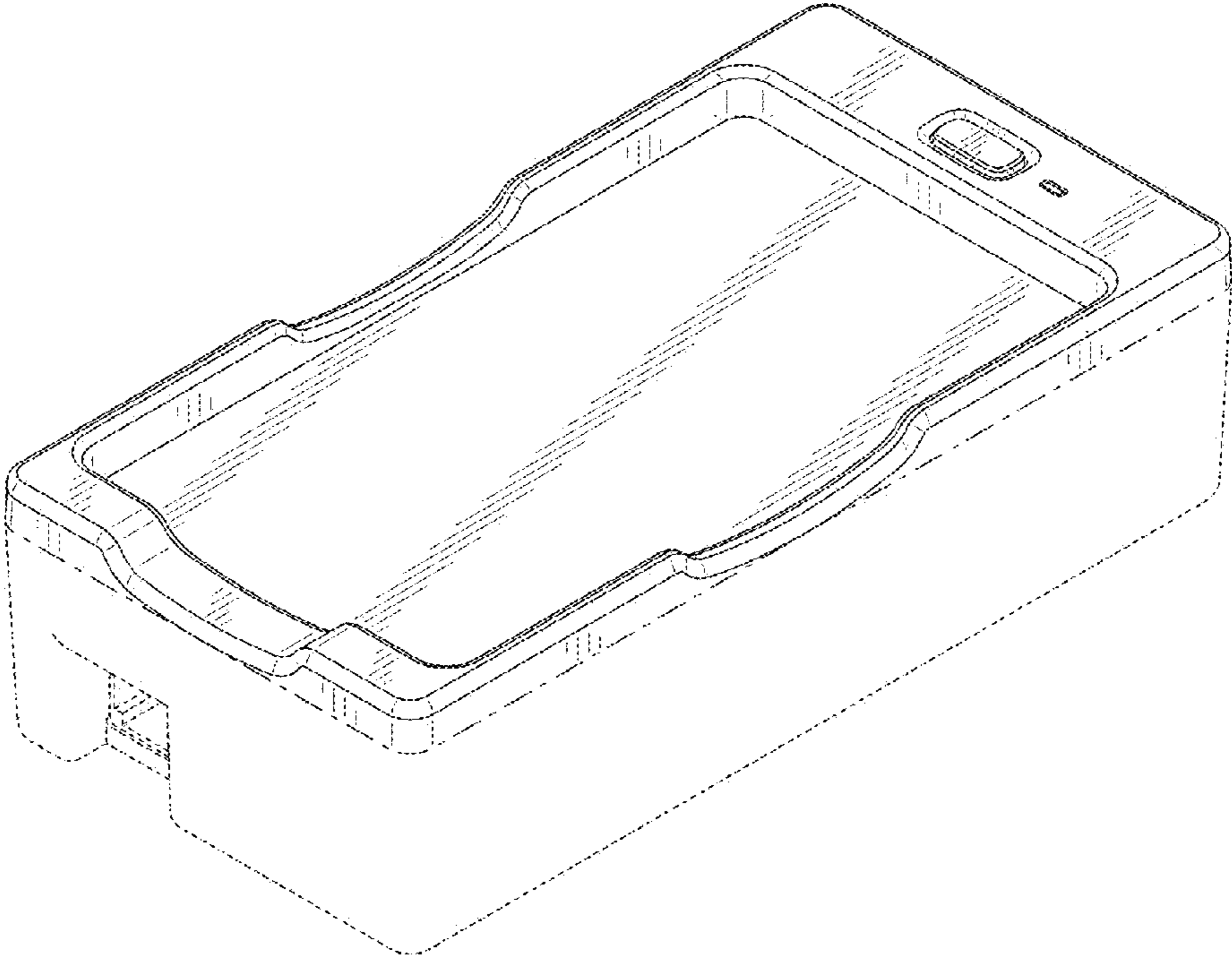

FIG.9

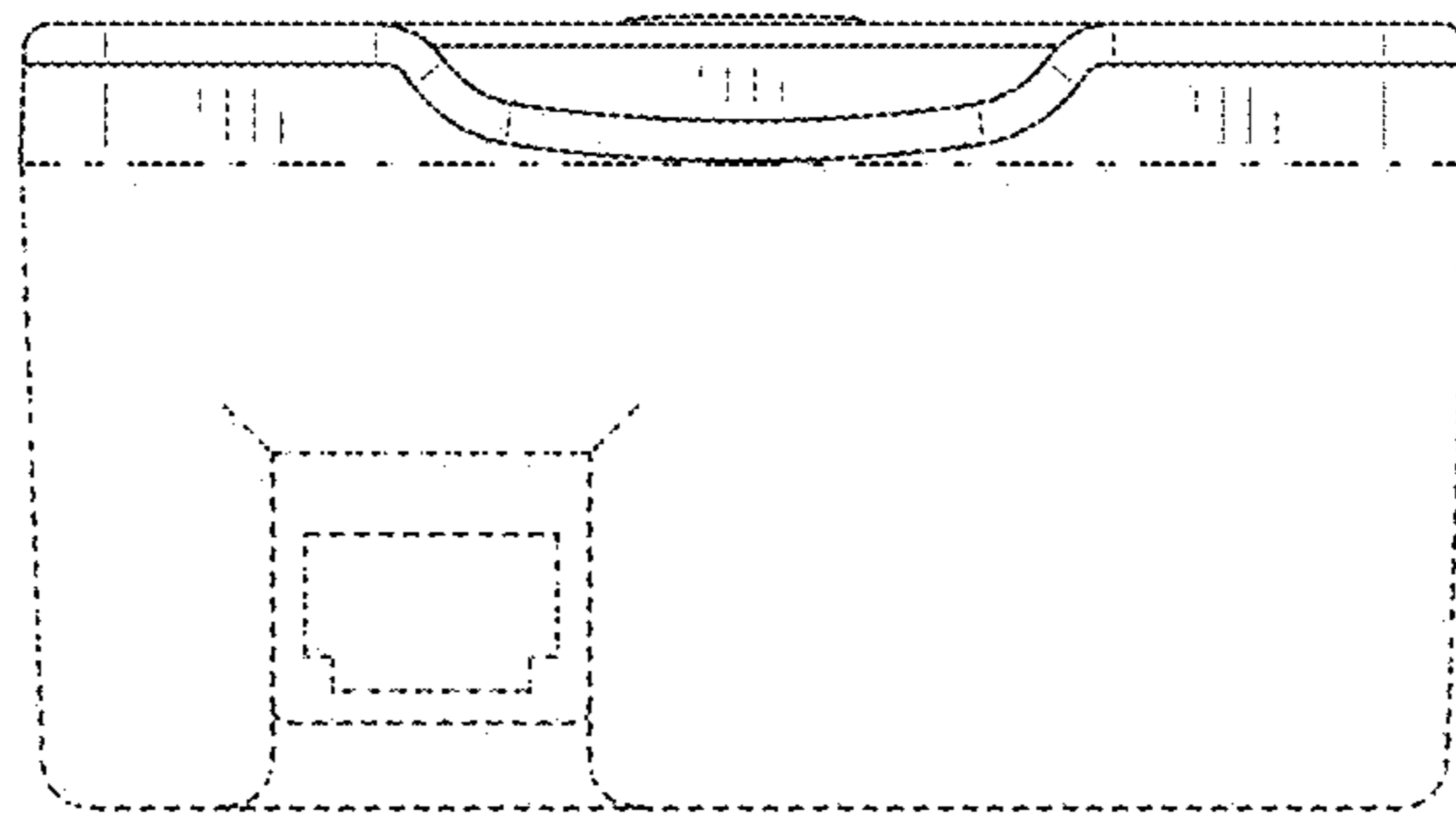

FIG. 10

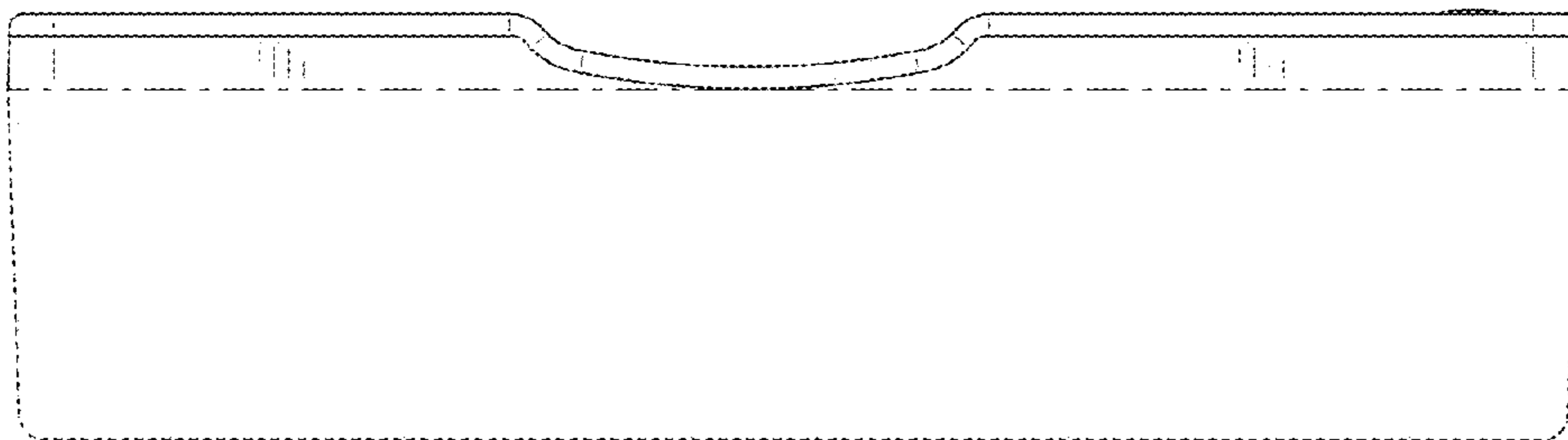

FIG. 11

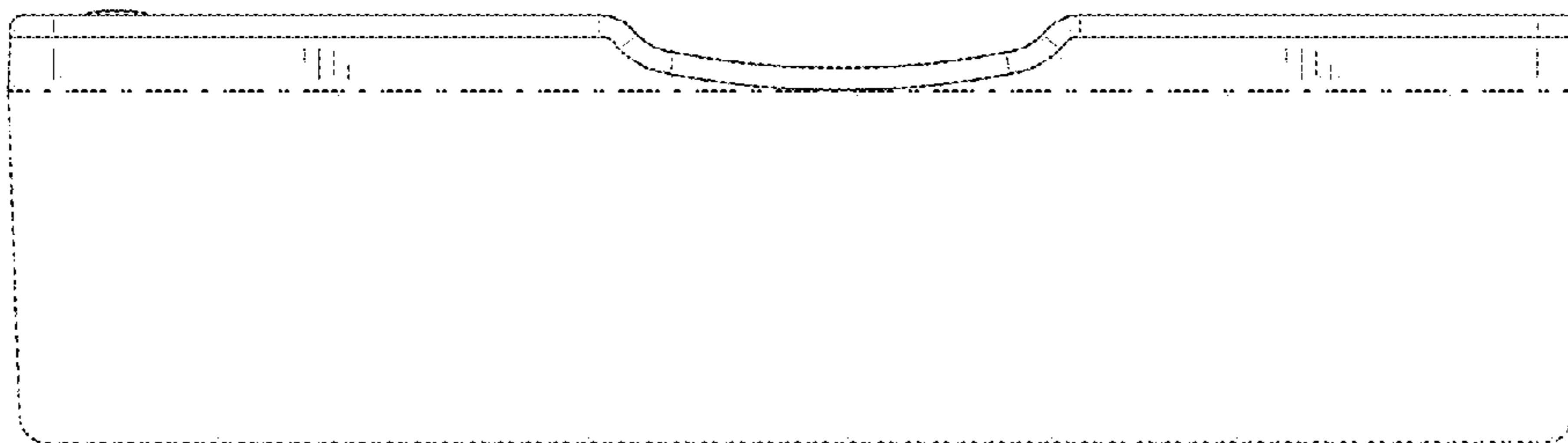

FIG. 12

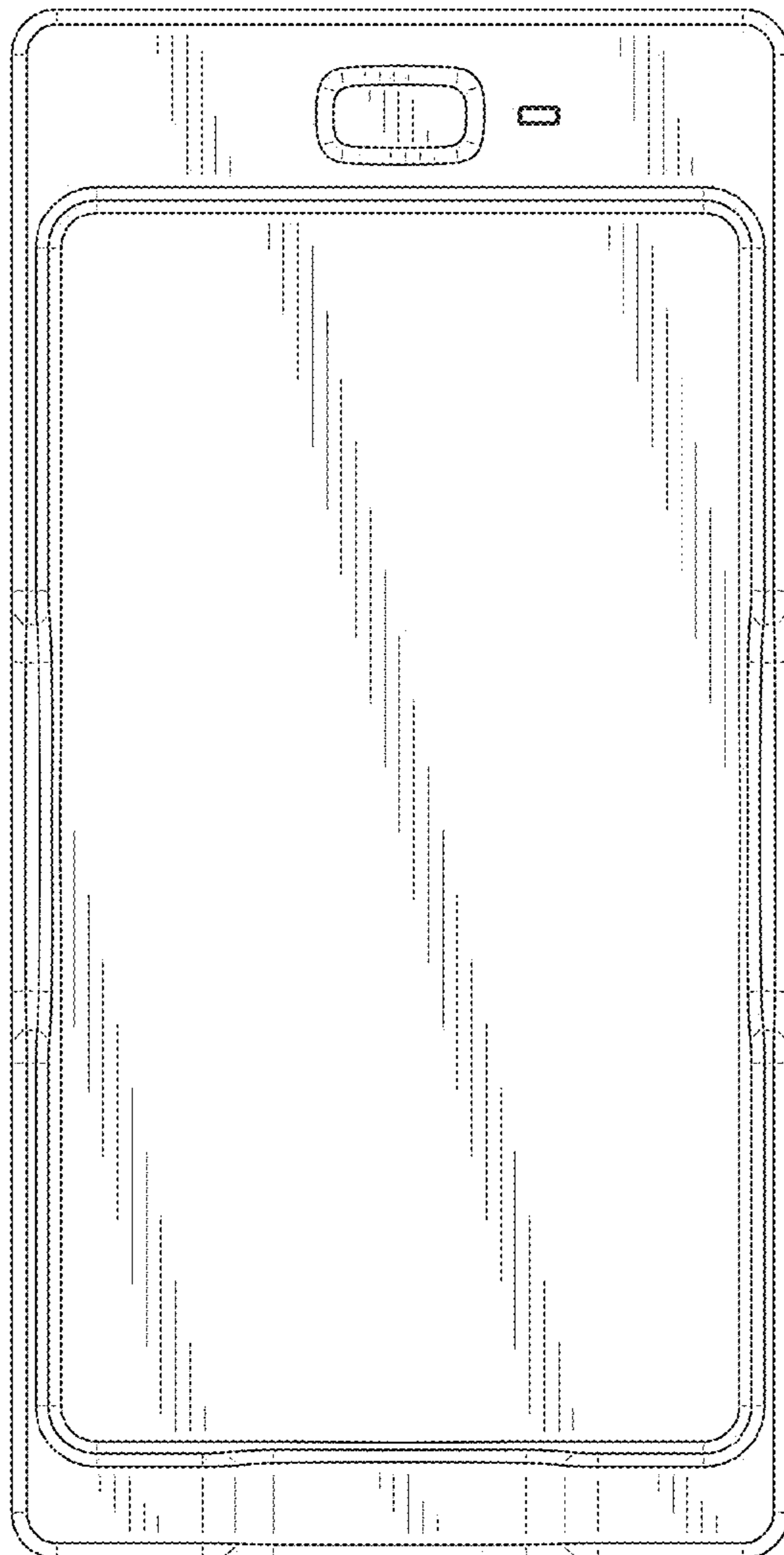

FIG. 13

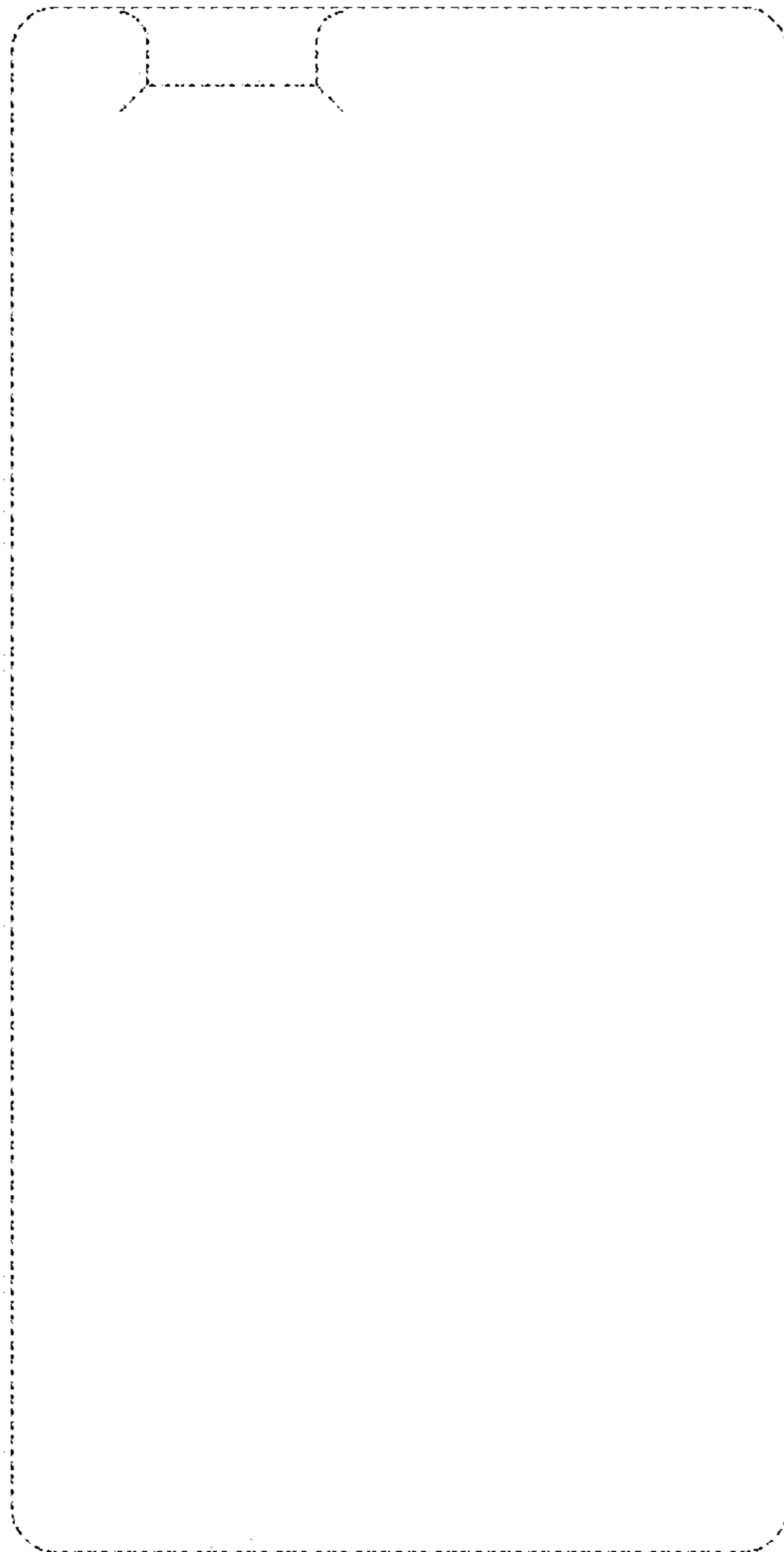

FIG. 14

