



US00D718191S

(12) **United States Design Patent**
May

(10) **Patent No.:** **US D718,191 S**

(45) **Date of Patent:** **** Nov. 25, 2014**

- (54) **MOTORCYCLE SHIFT PEG PAD**
- (71) Applicant: **Kuryakyn Holdings, LLC**, Somerset, WI (US)
- (72) Inventor: **Darron B May**, Stillwater, MN (US)
- (73) Assignee: **Kuryakyn Holdings, LLC**, Somerset, WI (US)
- (**) Term: **14 Years**
- (21) Appl. No.: **29/472,996**
- (22) Filed: **Nov. 18, 2013**
- (51) **LOC (10) Cl.** **12-11**
- (52) **U.S. Cl.**
USPC **D12/114**
- (58) **Field of Classification Search**
USPC 280/291, 274, 281.1; 74/564; D12/114, D12/180; 70/233; D8/303, 39, 59, 67, 68, D8/80, 82, 83, 86, 106, 300, 308, 309; 29/428; 60/591; 403/348, 361; 340/454; D2/744, 747; 188/265, 18 A, 188/31, 72.7, 24.22, 1.11 W, 251 A, 24.19, 188/250 B, 24.11, 24.12, 73.1, 344, 238, 188/244, 2 D, 245, 250 G, 1.11 L
See application file for complete search history.

6,161,859	A *	12/2000	Cheng	280/291
D506,707	S *	6/2005	Egan	D12/114
6,916,034	B2 *	7/2005	Elliott	280/291
D512,894	S *	12/2005	Nimphius	D8/303
D560,562	S *	1/2008	Egan et al.	D12/114
7,316,302	B2 *	1/2008	Hogesta	188/265
2004/0074334	A1 *	4/2004	Khiev	74/564
2004/0200312	A1 *	10/2004	Buckhouse et al.	74/564
2005/0012300	A1 *	1/2005	Egan	280/291
2011/0260972	A1 *	10/2011	Huang	345/163
2012/0262375	A1 *	10/2012	Tello	345/163

* cited by examiner

Primary Examiner — Eric Goodman

Assistant Examiner — Ryan Harvey

(74) *Attorney, Agent, or Firm* — Dicke, Billig & Czaja, PLLC

(57) **CLAIM**

The ornamental design for a motorcycle shift peg pad, as shown and described.

DESCRIPTION

FIG. 1 is a front perspective view of the motorcycle shift peg pad of the present invention.
 FIG. 2 is a top view thereof.
 FIG. 3 is a bottom view thereof.
 FIG. 4 is a front view thereof, the rear view being a mirror image thereof.
 FIG. 5 is a first end view thereof; and,
 FIG. 6 is a second end view thereof, opposite the first end view.
 The motorcycle shift peg, the shift peg pad shown in the bottom view, and the shift peg pad top surface portions shown in broken lines form no part of the claimed design.

1 Claim, 5 Drawing Sheets

(56) **References Cited**

U.S. PATENT DOCUMENTS

D319,037	S *	8/1991	Hoepfner, III	D12/114
D392,535	S *	3/1998	Vasudeva et al.	D8/83
D405,393	S *	2/1999	Stahel	D12/114

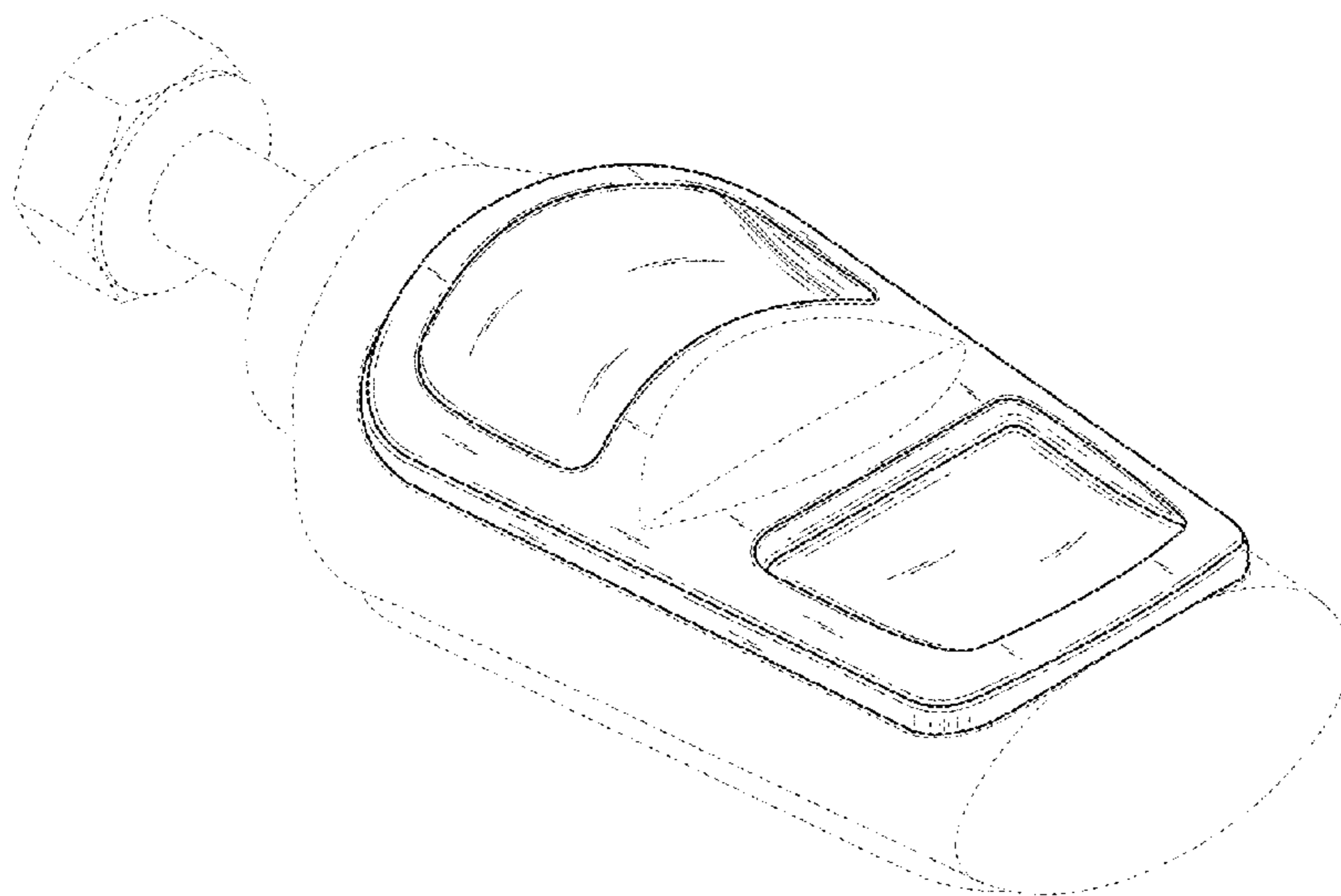

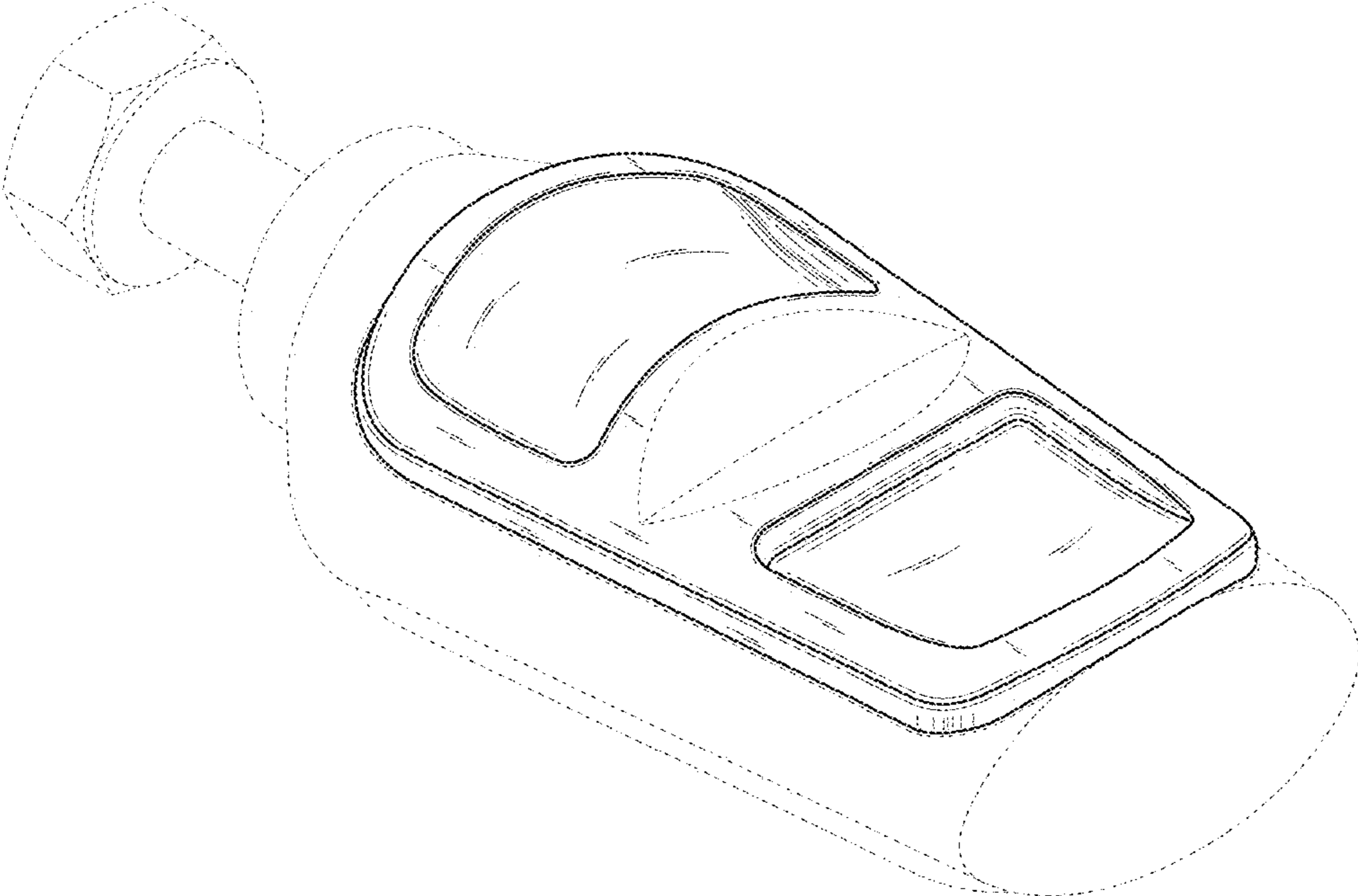

Fig. 1

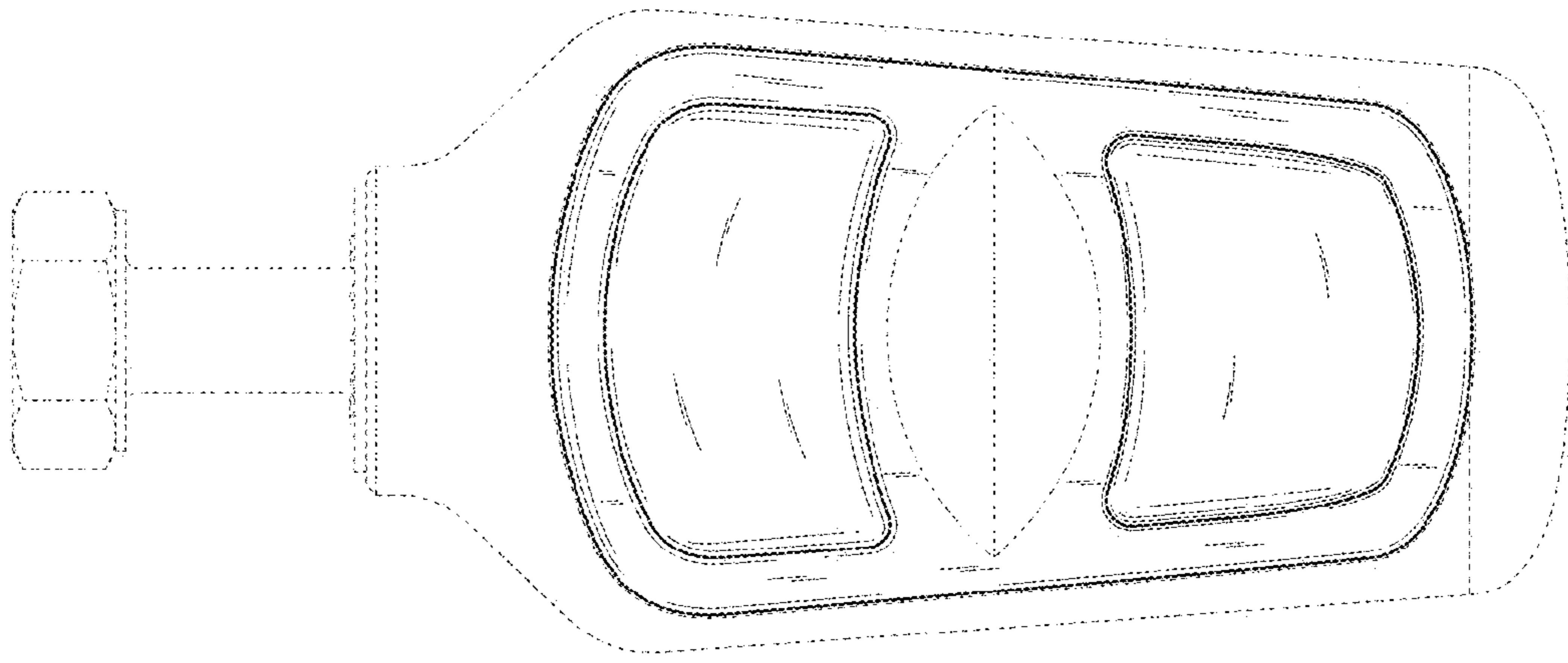

Fig. 2

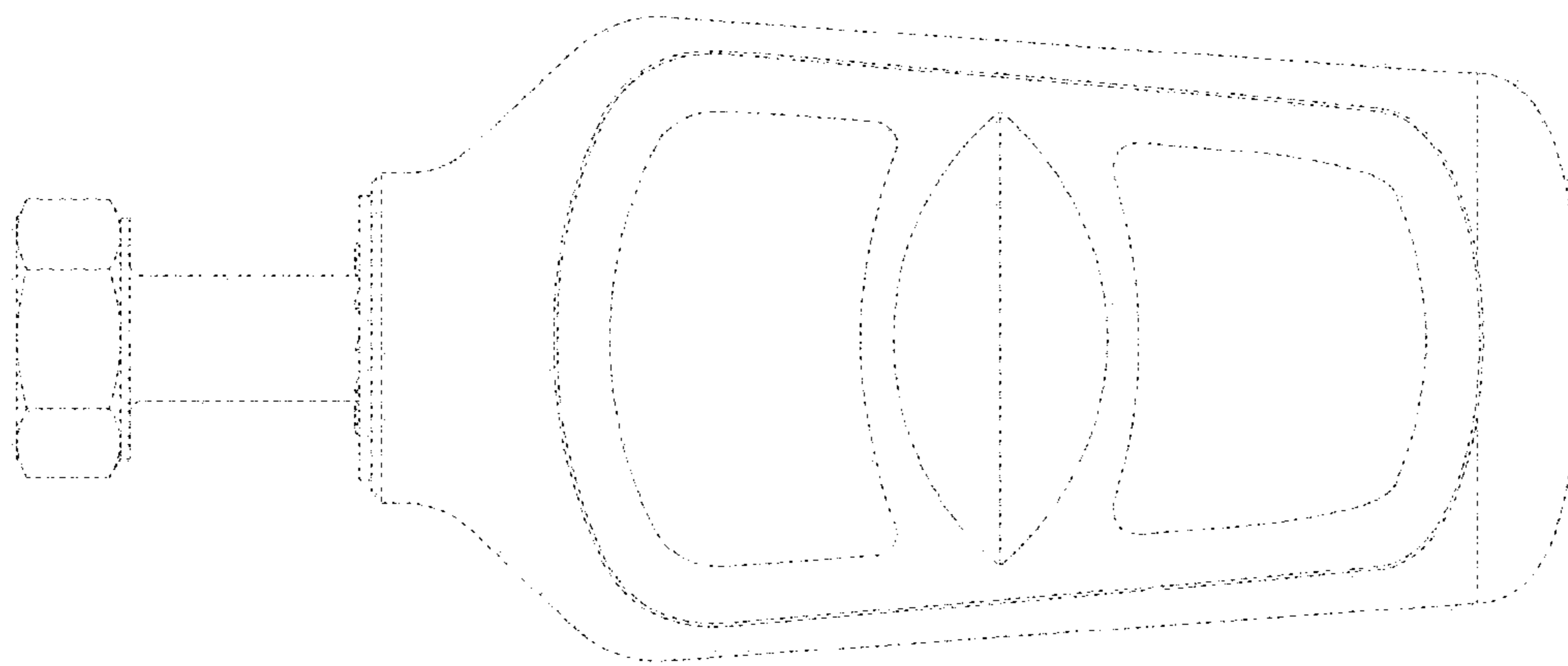

Fig. 3

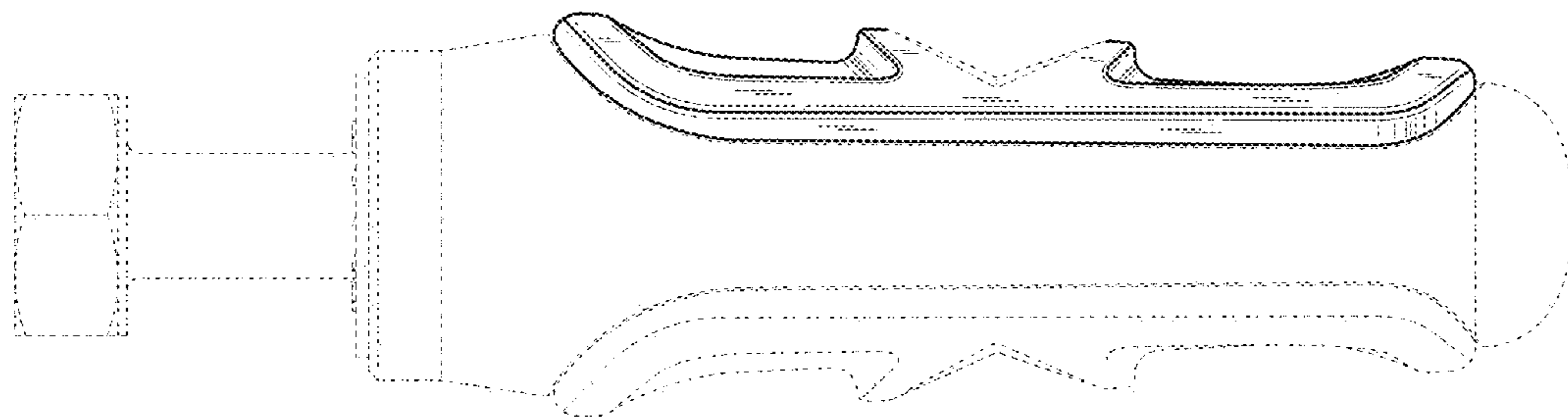

Fig. 4

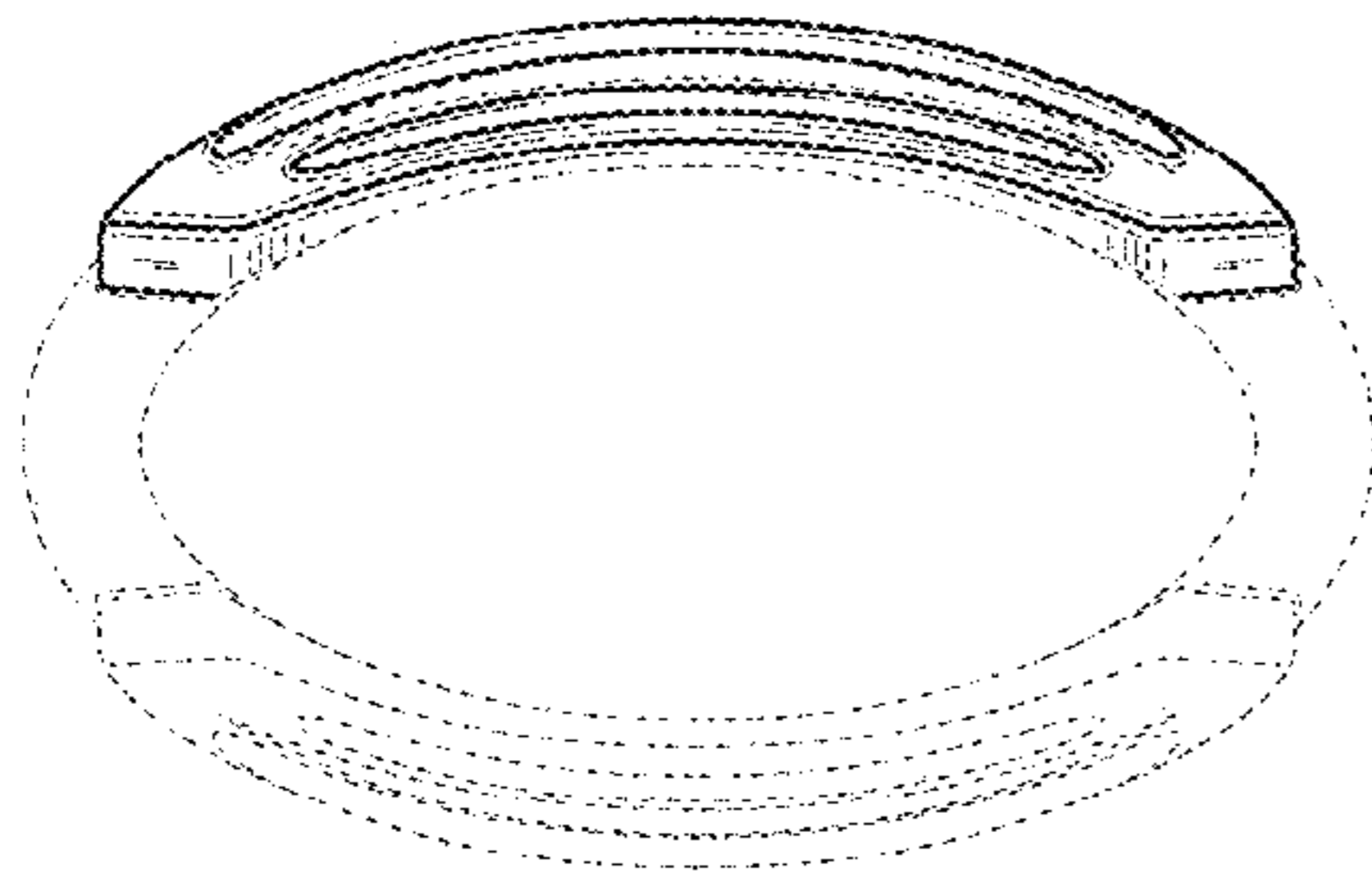

Fig. 5

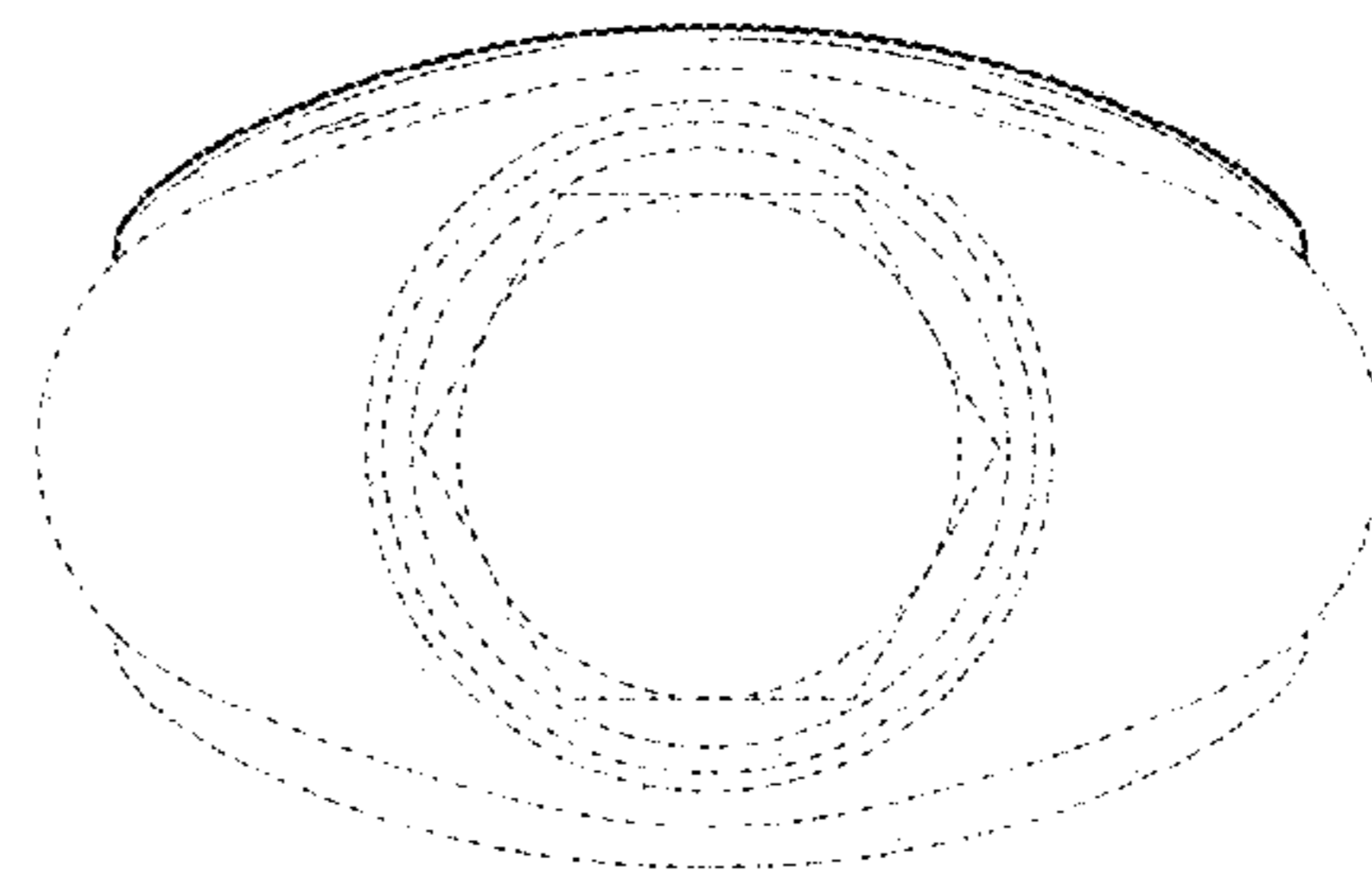

Fig. 6