



US00D718136S

(12) **United States Design Patent**
Harrity

(10) **Patent No.:** **US D718,136 S**

(45) **Date of Patent:** **** Nov. 25, 2014**

(54) **RING COLLAR**

(71) Applicant: **Tapones Escobar S.A. de C.V.**, Alvaro Obregón (MX)

(72) Inventor: **Miguel Francisco Escobar Harrity**, Alvaro Obregon (MX)

(73) Assignee: **Tapones Escobar S.A. de C.V.** (MX)

(**) Term: **14 Years**

(21) Appl. No.: **29/453,156**

(22) Filed: **Apr. 25, 2013**

(30) **Foreign Application Priority Data**

Nov. 22, 2012 (MX) 2012/003703

(51) **LOC (10) Cl.** **09-99**

(52) **U.S. Cl.**
USPC **D9/499**

(58) **Field of Classification Search**
CPC B65D 47/12
USPC D9/435, 436, 442, 443, 444, 445, 446,
D9/499, 528, 529, 539, 686, 687, 688;
D8/352; 206/221, 222; 215/216;
220/253, 713; 222/525

See application file for complete search history.

(56) **References Cited**

U.S. PATENT DOCUMENTS

2,249,272	A *	7/1941	Dey	292/357
4,069,942	A *	1/1978	Marshall et al.	221/4
4,142,748	A *	3/1979	Hook	292/169.15
4,393,977	A *	7/1983	Willingham	215/211
D290,527	S *	6/1987	Thorogood	D28/10
5,242,067	A *	9/1993	Garby et al.	215/230
D380,133	S *	6/1997	Rochette et al.	D8/301
D417,847	S *	12/1999	Rush et al.	D9/454
D495,060	S *	8/2004	Hellstrom	D24/224
6,880,729	B2 *	4/2005	Stull et al.	222/153.14
D525,127	S *	7/2006	Cogley et al.	D9/456

D562,133	S *	2/2008	Liebe et al.	D9/449
D610,176	S *	2/2010	Nagamine et al.	D15/138
D611,817	S *	3/2010	Simmons et al.	D9/504
D627,216	S *	11/2010	Fulginiti	D8/499
8,087,272	B1 *	1/2012	Korban	70/224
D657,665	S *	4/2012	Rivera et al.	D9/434
D660,700	S *	5/2012	MacNeill et al.	D9/454
D665,491	S *	8/2012	Goel et al.	D23/386
2010/0258522	A1 *	10/2010	Escobar et al.	215/364

OTHER PUBLICATIONS

.5 inch White Plastic Escutcheons, pexuniverse.com, (c) 2009-2014, found online at <http://www.pexuniverse.com/store/product/461>.
Stainless Steel Round Escutcheon, yourpoolhq.com, (c) 2010-2014, 3 pages, found online at https://www.yourpoolhq.com/stainless-steel-escutcheon.html?utm_source=googleproduct&gdftrk=gdfV22205_a_7c1225_a_7c7252_a_7cPER_d_35_d_729&gclid=Cj0KEQjw_42eBRDHqcG1psmtneEBEiQAWPL8WJg_oJvndJkf6Qn4o4zASRgTiNxCBjHyKPBWfBFnyrgaAIWu8P8HAQ.*

* cited by examiner

Primary Examiner — Robert M Spear

(74) *Attorney, Agent, or Firm* — Banner & Witcoff, Ltd.

(57) **CLAIM**

The ornamental design for a ring collar, as shown and described.

DESCRIPTION

FIG. 1 is a perspective view of a ring collar showing my new design;
FIG. 2 is a rear view thereof;
FIG. 3 is a top view thereof
FIG. 4 is a bottom view thereof;
FIG. 5 is a right side view, the left view is a mirror image thereof; and,
FIG. 6 is a front view thereof depicted on disclaimed bottle. The broken line showing in FIG. 6 of a disclaimed bottle represents disclaimed subject matter, is for environmental purposes only, and forms no part of the claimed design.

1 Claim, 1 Drawing Sheet

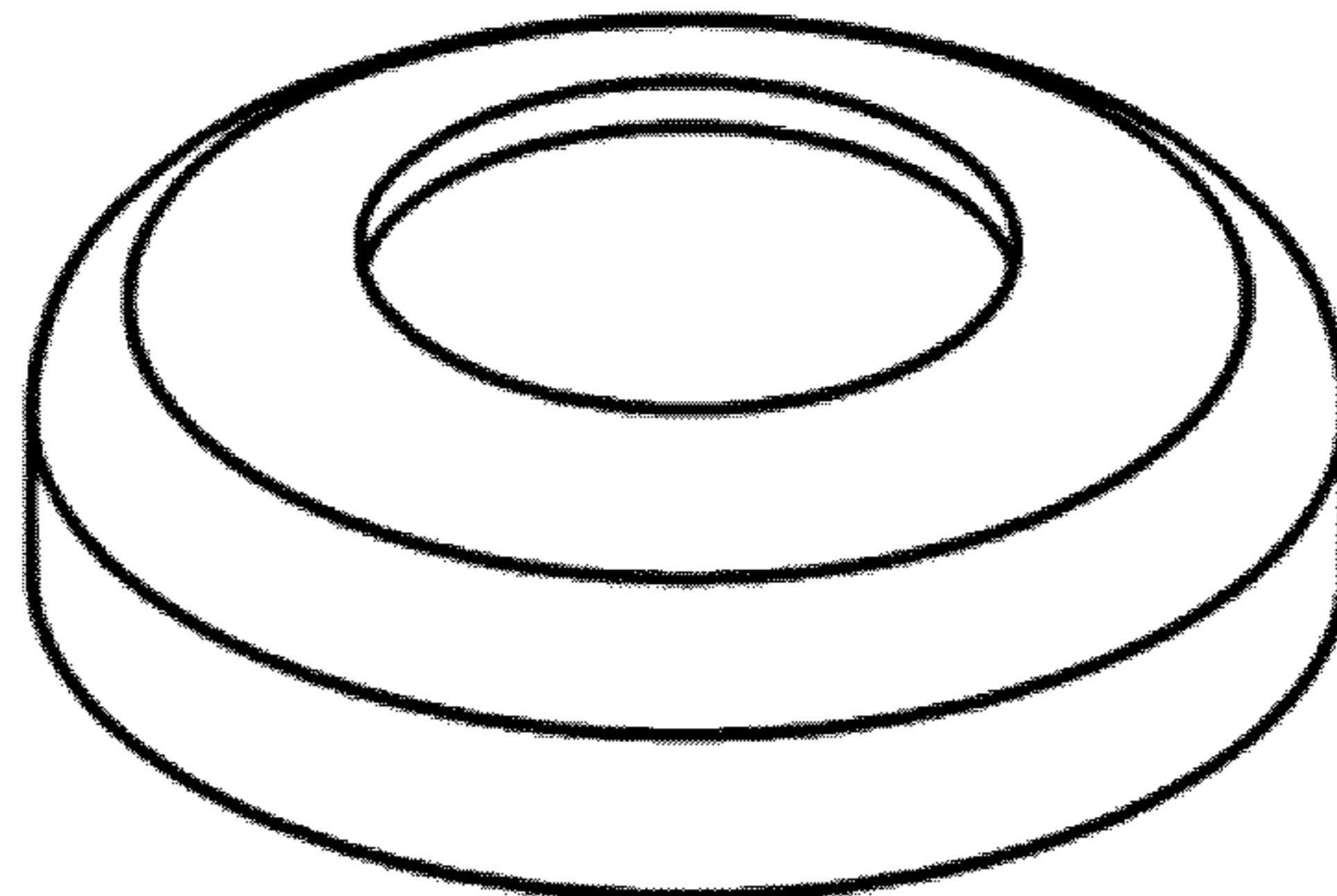

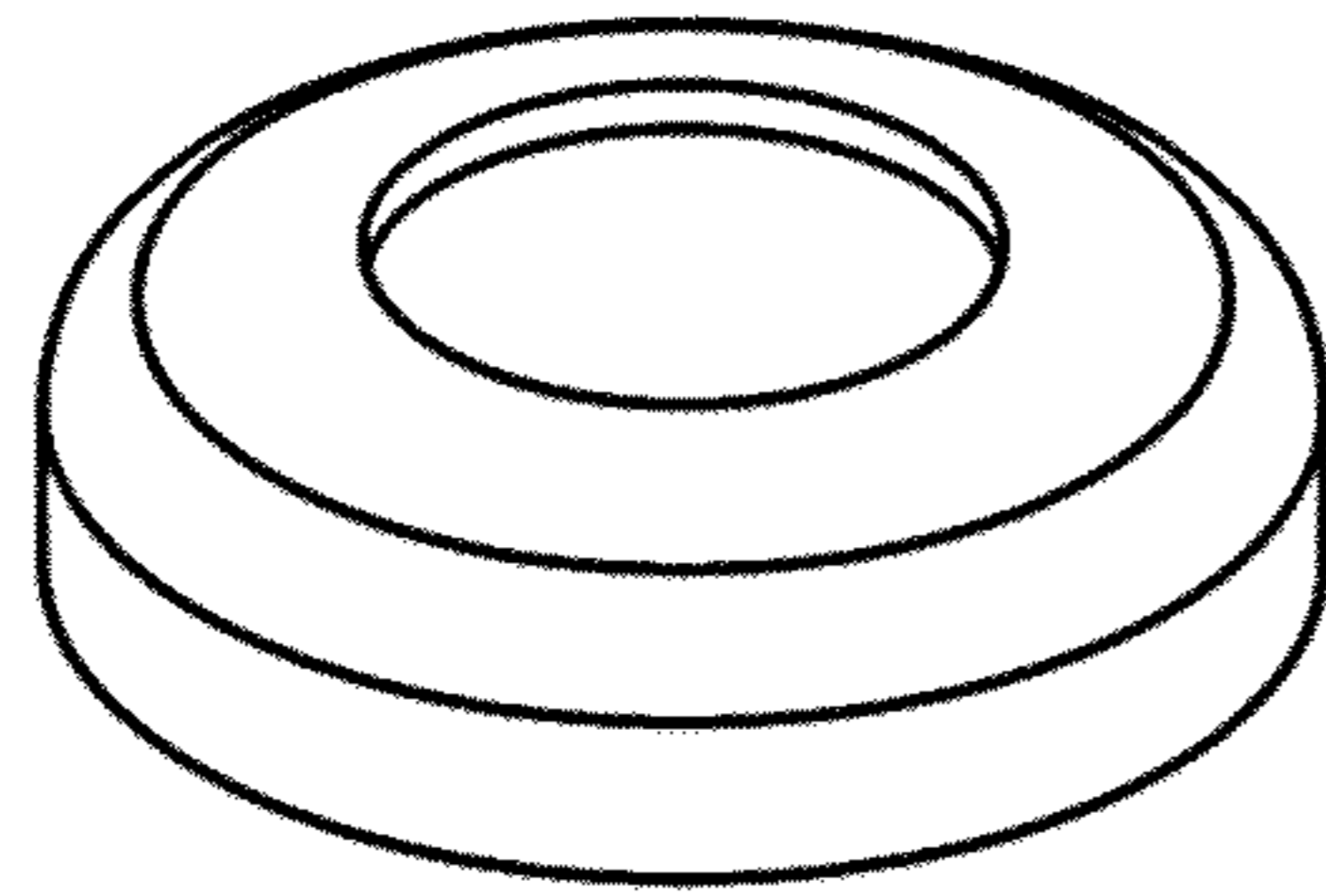

FIG. 1

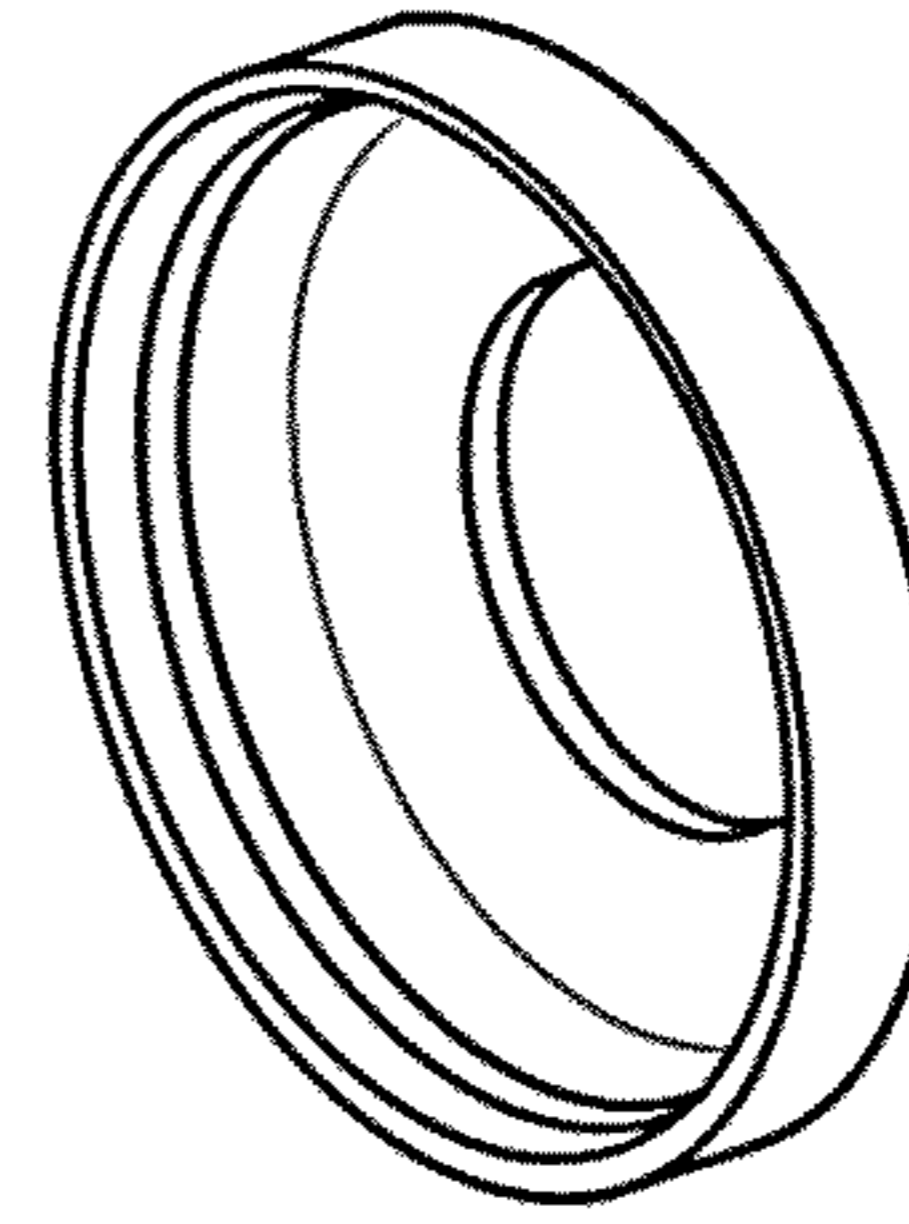

FIG. 2

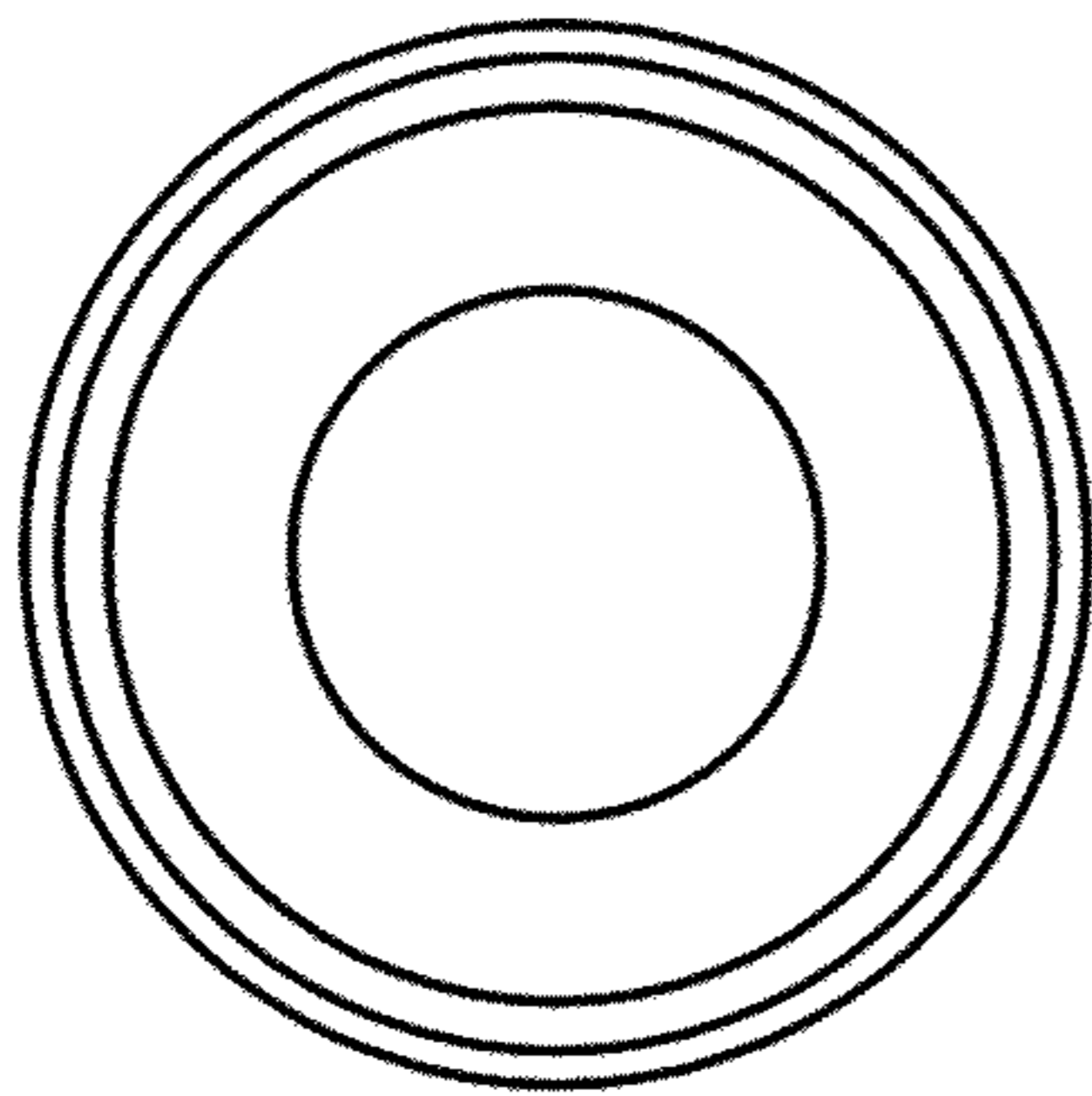

FIG. 3

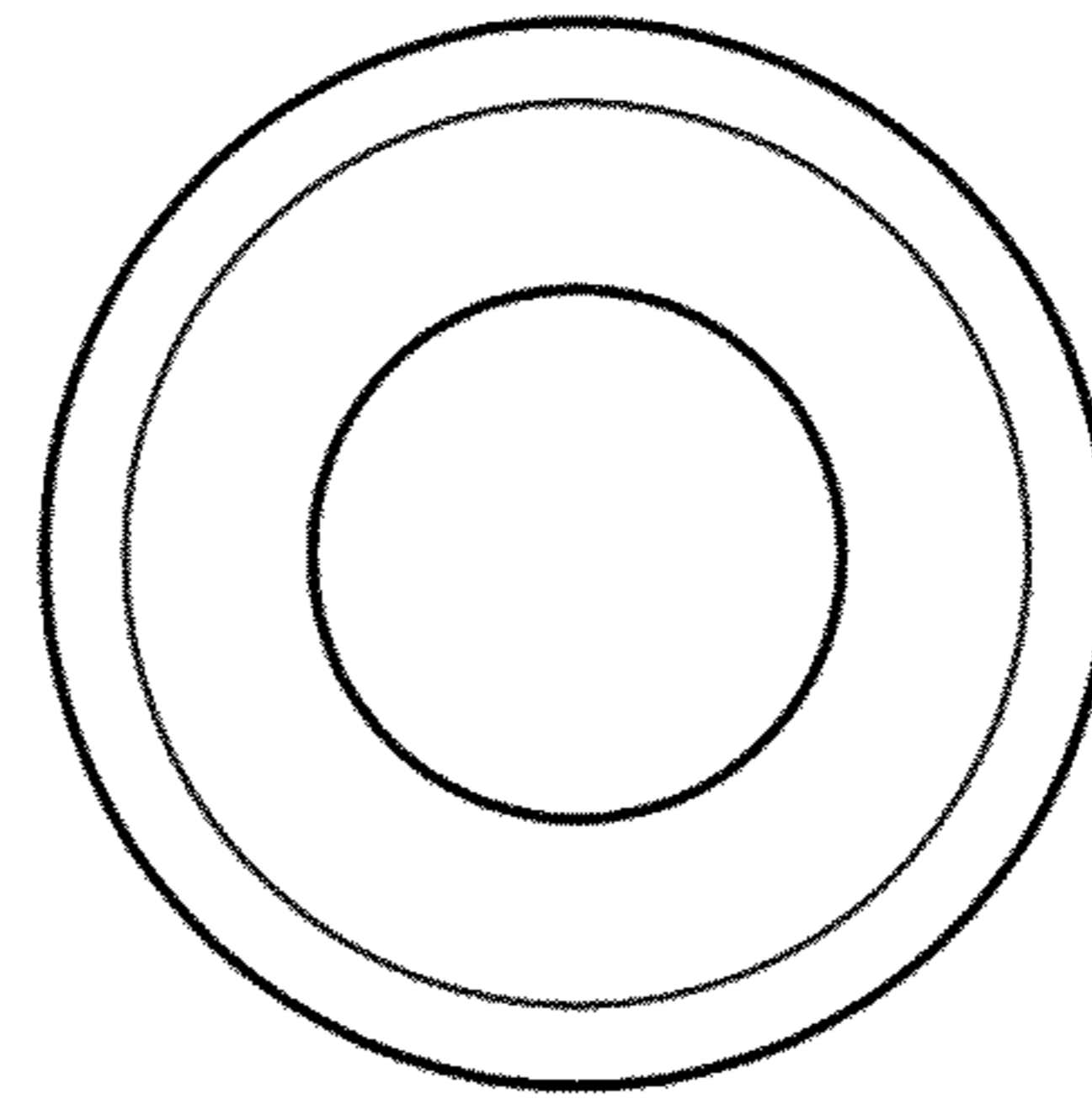

FIG. 4

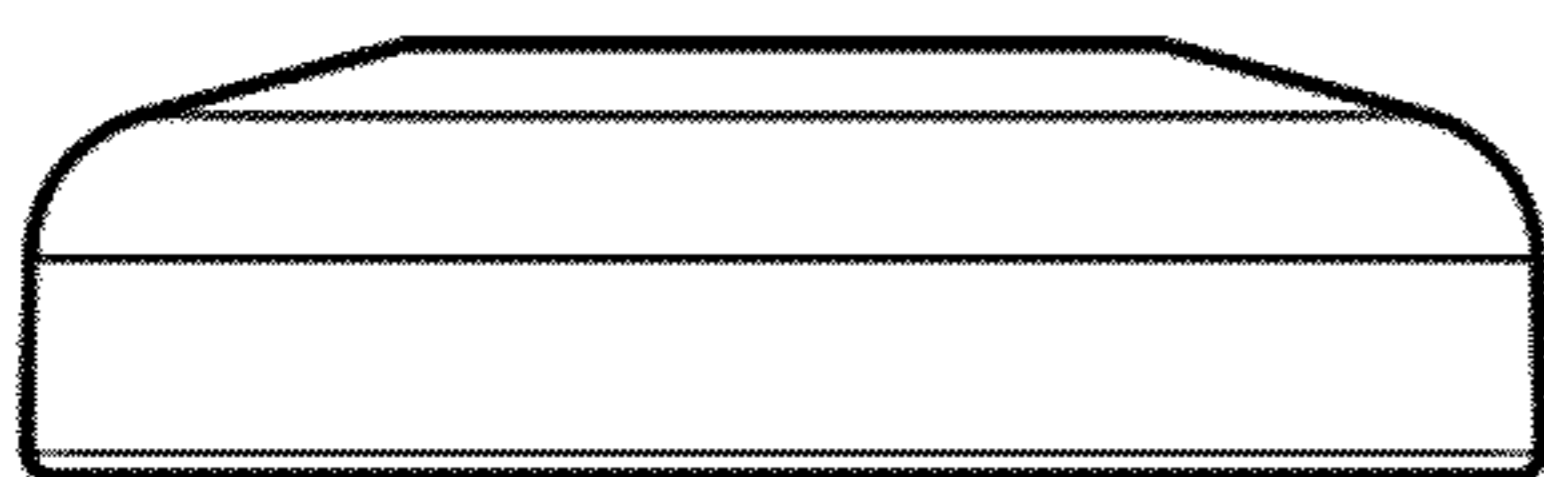

FIG. 5

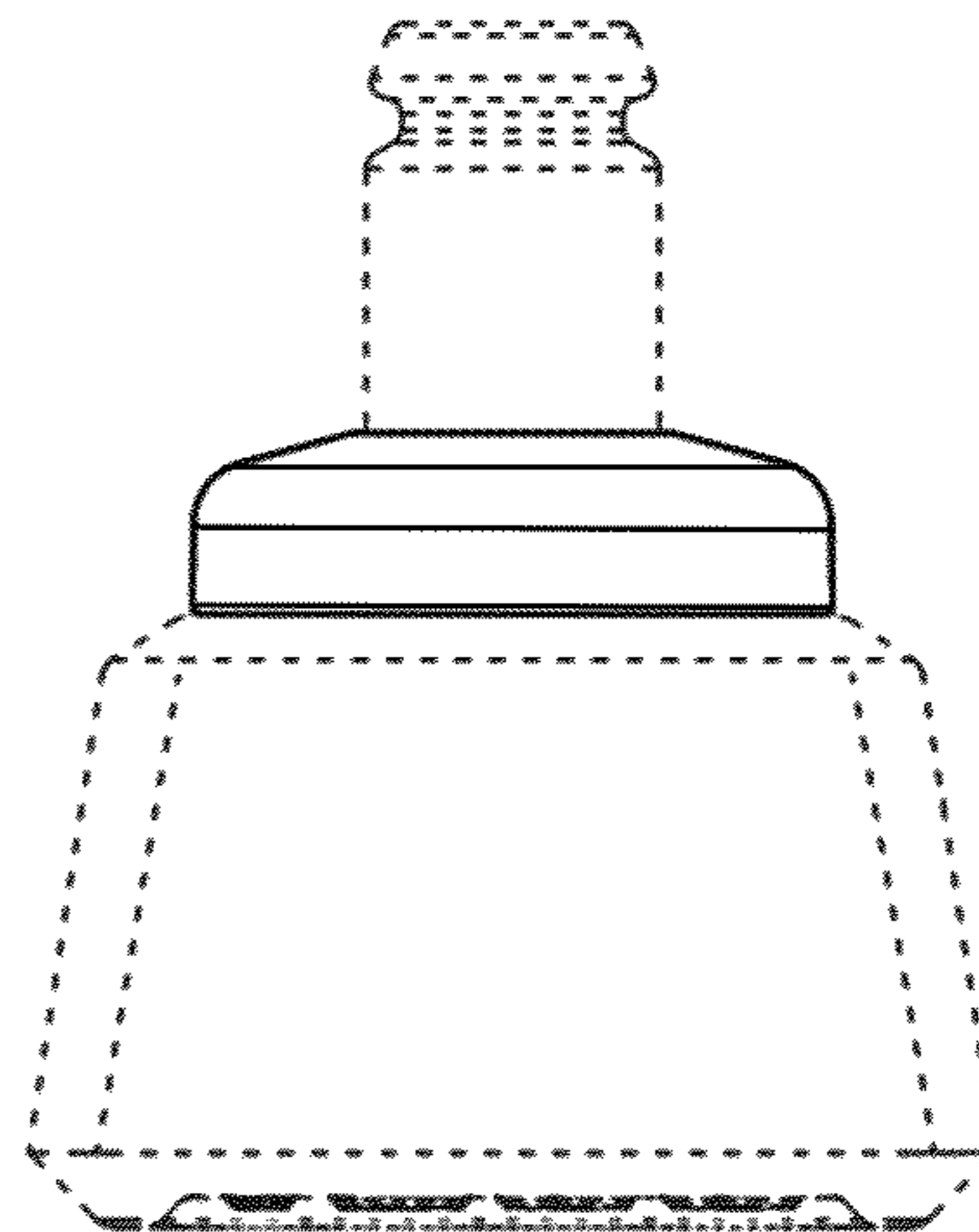

FIG. 6