



US00D717990S

(12) **United States Design Patent**
Nakai et al.

(10) **Patent No.:** **US D717,990 S**
(45) **Date of Patent:** **** Nov. 18, 2014**

(54) **ORGANIC LIGHT EMITTING DIODE DEVICE**

(71) Applicant: **Nitto Denko Corporation**, Ibaraki (JP)

(72) Inventors: **Takahiro Nakai**, Ibaraki (JP); **Toshitaka Nakamura**, Ibaraki (JP); **Satoru Yamamoto**, Ibaraki (JP)

(73) Assignee: **Nitto Denko Corporation**, Osaka (JP)

(**) Term: **14 Years**

(21) Appl. No.: **29/486,783**

(22) Filed: **Apr. 2, 2014**

(30) **Foreign Application Priority Data**

Oct. 3, 2013 (JP) 2013-023202

(51) **LOC (10) Cl.** **26-99**

(52) **U.S. Cl.**
USPC **D26/120**

(58) **Field of Classification Search**
USPC D26/85, 86, 89, 87, 113, 120, 122, 124,
D26/125, 118, 119, 128, 92, 65, 64, 63, 66,
D26/67, 69, 1, 2, 74, 75, 76, 78; 362/364,
362/362, 342, 223, 236, 247, 224, 147;
D13/179, 180
See application file for complete search history.

(56) **References Cited**

U.S. PATENT DOCUMENTS

D421,146	S	*	2/2000	Poulton	D26/76
D493,244	S	*	7/2004	Engel	D26/76
D496,746	S	*	9/2004	Herst et al.	D26/76
D496,747	S	*	9/2004	Herst et al.	D26/76
D512,792	S	*	12/2005	Benensohn	D26/76
D570,026	S	*	5/2008	Waldmann	D26/76
D584,848	S	*	1/2009	Menke	D26/88
D600,398	S	*	9/2009	Nourishad et al.	D26/120
8,038,315	B1	*	10/2011	Santoro et al.	362/224

D650,509	S	*	12/2011	Wegger et al.	D26/90
D655,854	S	*	3/2012	Kim et al.	D26/89
D662,643	S	*	6/2012	Takahashi et al.	D26/76
8,231,258	B2	*	7/2012	Kim et al.	362/609
8,382,354	B2	*	2/2013	Kim et al.	362/606
D680,679	S	*	4/2013	Kim et al.	D26/118
D683,066	S	*	5/2013	Myung	D26/120
8,585,237	B2	*	11/2013	Kim et al.	362/224
D695,439	S	*	12/2013	Kim et al.	D26/72
D695,440	S	*	12/2013	Kim et al.	D26/72
D707,880	S	*	6/2014	Magnusson	D26/120

* cited by examiner

Primary Examiner — Kevin Rudzinski

(74) *Attorney, Agent, or Firm* — The Webb Law Firm

(57) **CLAIM**

The ornamental design for an organic light emitting diode device, as shown and described.

DESCRIPTION

FIG. 1 is a front view of an organic light emitting diode device showing our new design;
FIG. 2 is a rear view thereof;
FIG. 3 is a top view thereof;
FIG. 4 is a right side view thereof;
FIG. 5 is a cross-sectional view thereof taken along lines 5-5 shown in FIG. 1;
FIG. 6 is a cross-sectional view thereof taken along lines 6-6 shown in FIG. 1;
FIG. 7 is an enlarged cross-sectional view of an area thereof taken along lines 7-7 shown in FIG. 5; and,
FIG. 8 is an enlarged top view of an area thereof taken along lines 8-8 shown in FIG. 3.

A bottom view and a left side view of the organic light emitting diode device are omitted as they are symmetric in appearance to the top view of FIG. 3 and the right side view of FIG. 4, respectively.

The broken line showings of FIGS. 5-7 are environmental only and not part of the claimed design.

1 Claim, 4 Drawing Sheets

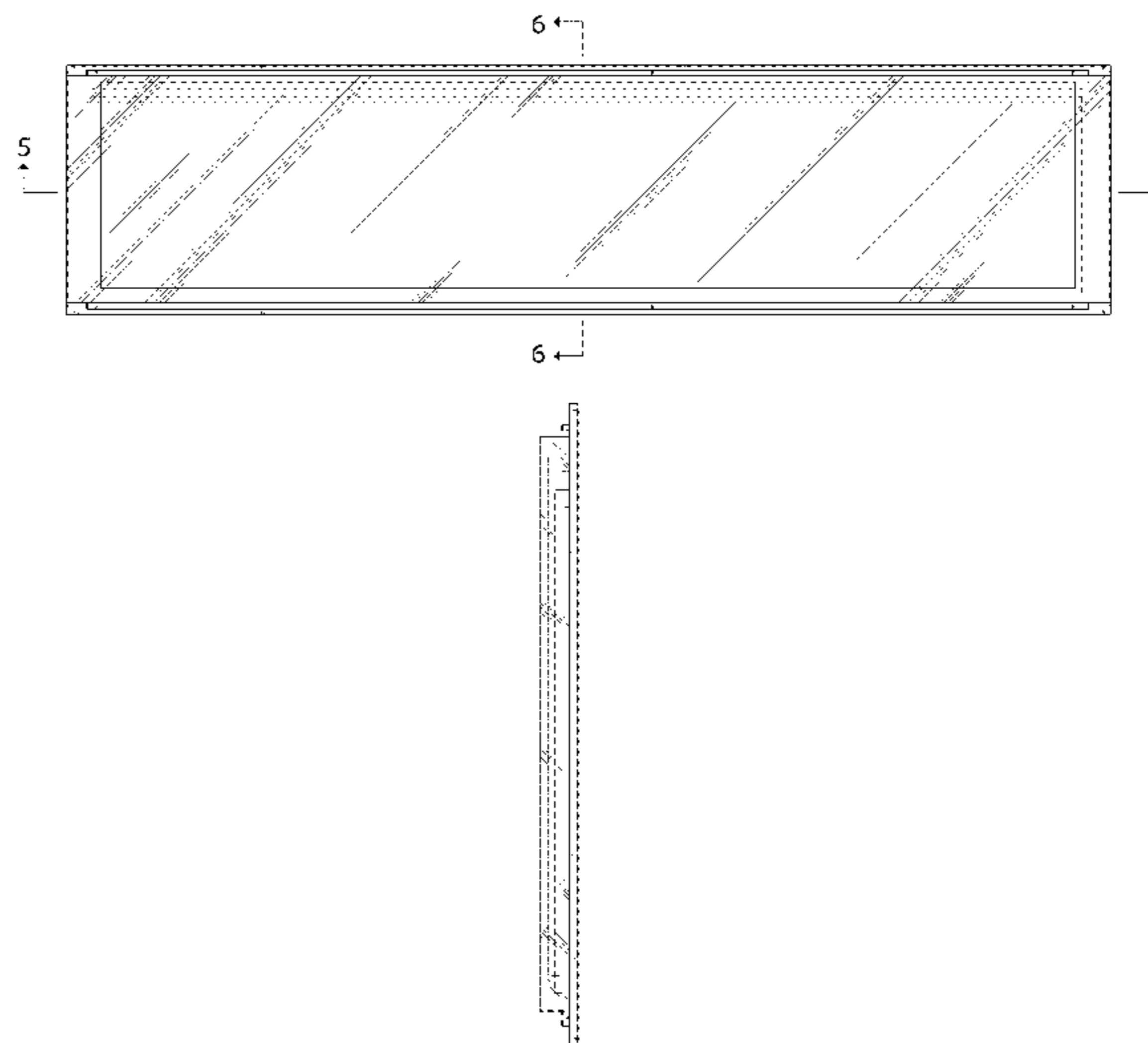

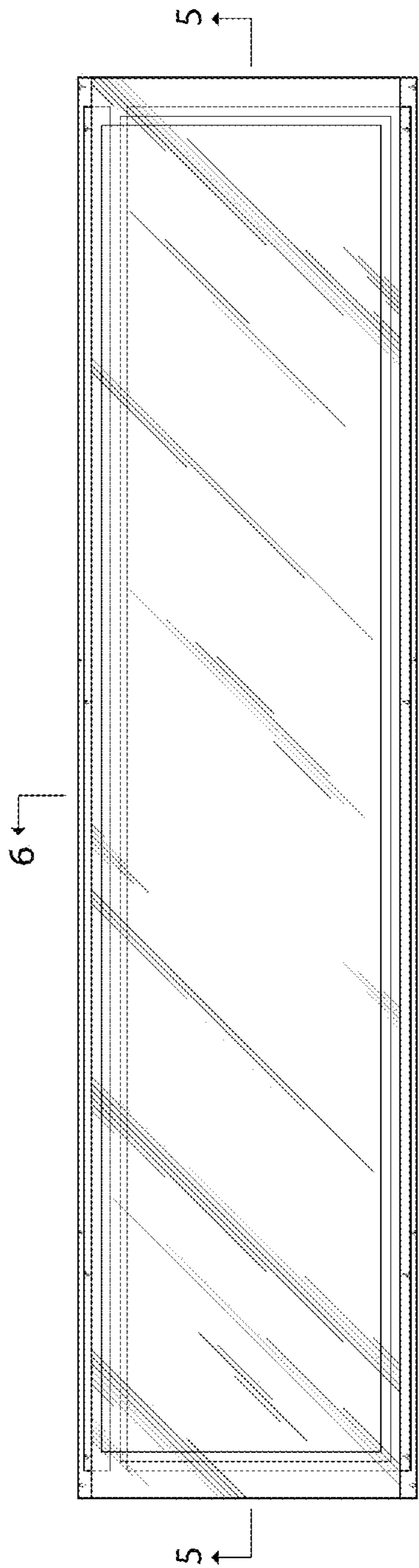

FIG. 1

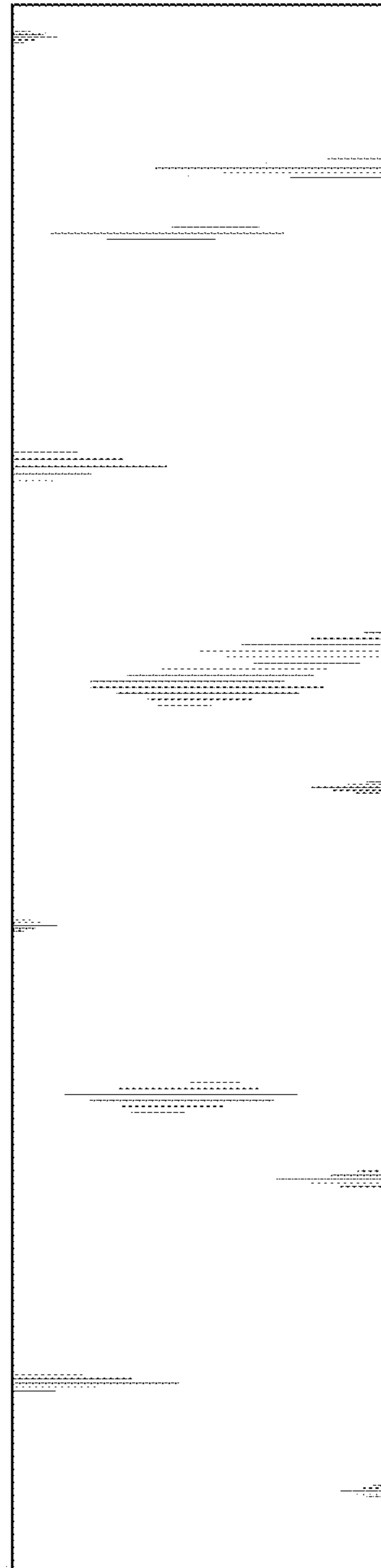

FIG. 2

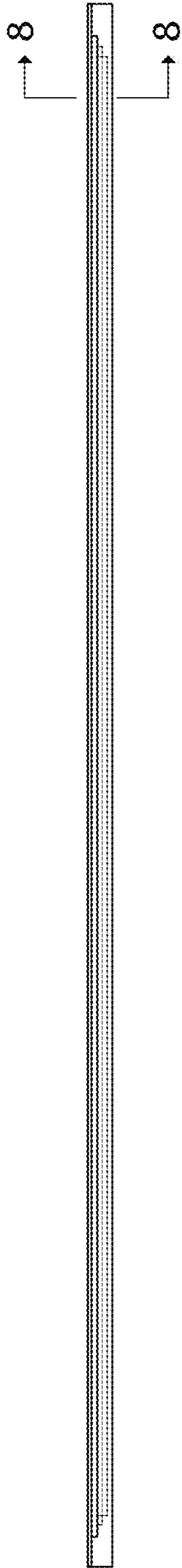

FIG. 3

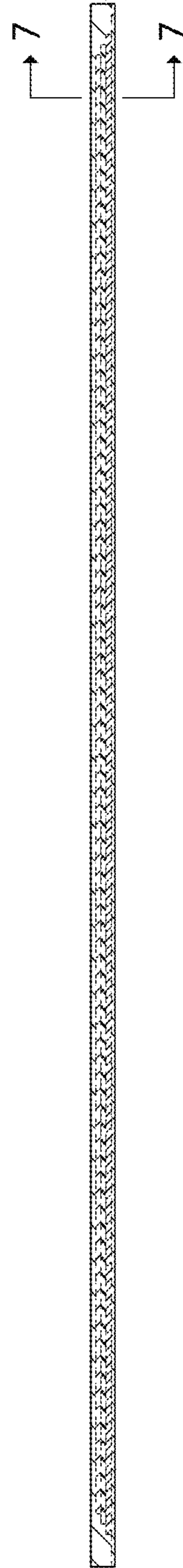

FIG. 5



FIG. 6

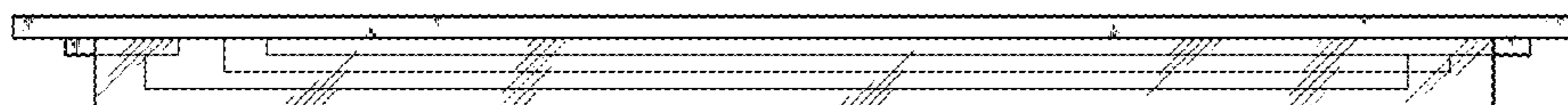

FIG. 4

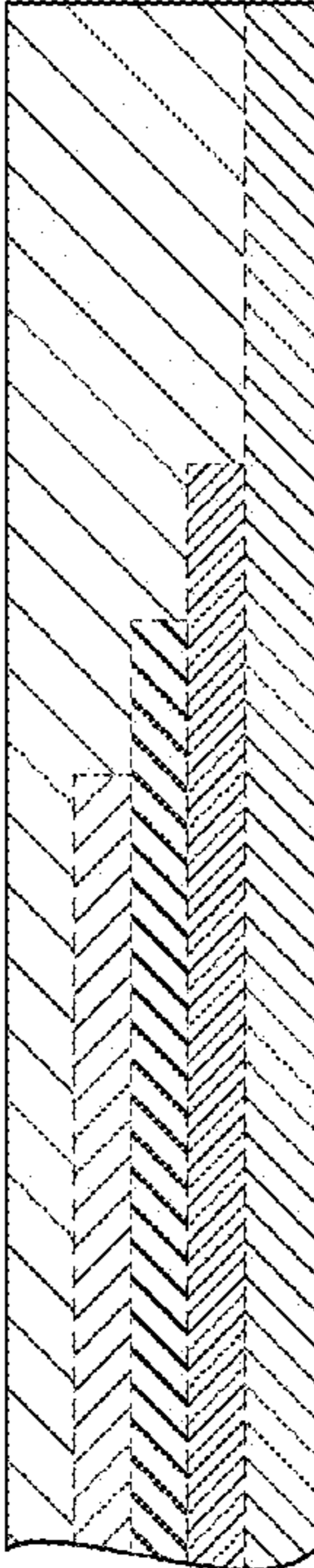
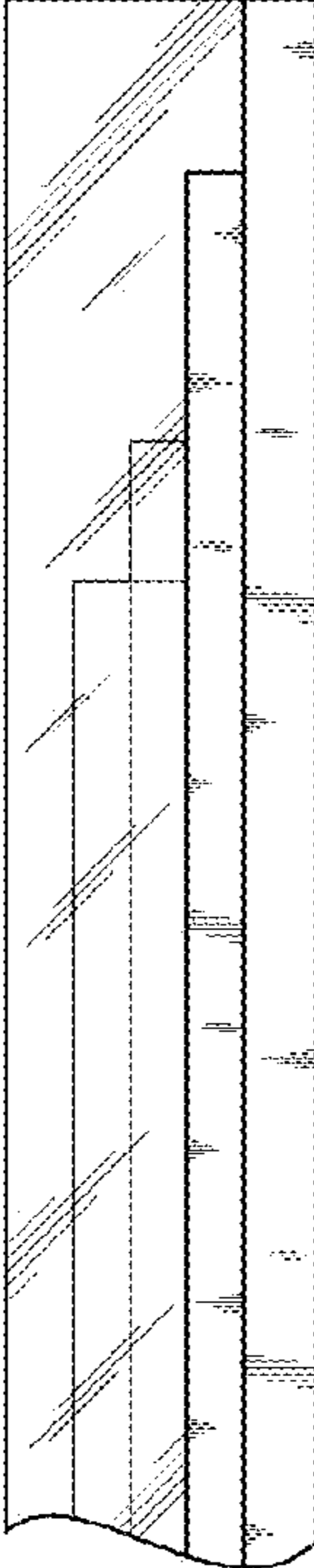

FIG. 8

FIG. 7