



US00D717950S

(12) **United States Design Patent**
Agrawal

(10) **Patent No.:** **US D717,950 S**
(45) **Date of Patent:** **** Nov. 18, 2014**

(54) **REUSABLE TAMPON APPLICATOR**

(71) Applicant: **Thinx LLC**, New York, NY (US)

(72) Inventor: **Miki Agrawal**, Brooklyn, NY (US)

(73) Assignee: **Thinx, LLC**, New York, NY (US)

(**) Term: **14 Years**

(21) Appl. No.: **29/498,967**

(22) Filed: **Aug. 10, 2014**

(51) **LOC (10) Cl.** **24-02**

(52) **U.S. Cl.**

USPC **D24/141**

(58) **Field of Classification Search**

USPC D24/141, 114, 135, 113, 125, 127, 129,
D24/112, 130; D3/203.5; 604/11, 14-18,
604/206, 904, 218, 227, 358, 187, 288, 363

See application file for complete search history.

(56) **References Cited**

U.S. PATENT DOCUMENTS

D156,948 S 1/1950 Fisher
3,247,698 A * 4/1966 Baldwin et al. 604/187
3,397,695 A * 8/1968 Voss D24/125

(Continued)

OTHER PUBLICATIONS

Playtex, "Tampon products," website available at <http://www.playtexplayon.com/products/gentle-glide> Accessed on Jul. 27, 2014.

(Continued)

Primary Examiner — Wan Laymon

(74) *Attorney, Agent, or Firm* — American Patent Agency PC; Daniar Hussain; Karl P. Dresdner, Jr.

(57) **CLAIM**

The ornamental design for a reusable tampon applicator, as shown and described.

DESCRIPTION

FIG. 1 is an exploded perspective view showing the new design of a reusable tampon applicator, showing a cover (at a top of FIG. 1) that is used to encase a barrel (middle) and a plunger (bottom), the barrel used to hold a tampon (tampon not shown), and the plunger used to insert the tampon (not shown) through the barrel;

FIG. 2 is an assembled perspective view of the reusable tampon applicator, showing the cover with the enclosed barrel and plunger inside;

FIG. 3 is a perspective view of the cover of the reusable tampon applicator;

FIG. 4 is a front view thereof;

FIG. 5 is a back view thereof;

FIG. 6 is a left side view thereof;

FIG. 7 is a right side view thereof;

FIG. 8 is a top view thereof;

FIG. 9 is a bottom view thereof;

FIG. 10 is a perspective view of the barrel of the reusable tampon applicator that is used to hold the tampon (tampon not shown);

FIG. 11 is a front view thereof;

FIG. 12 is a right side view thereof;

FIG. 13 is a back view thereof;

FIG. 14 is a left side view thereof;

FIG. 15 is a top view thereof;

FIG. 16 is a bottom view thereof;

FIG. 17 is a perspective view of the plunger of the reusable tampon applicator that is used for inserting the tampon (tampon not shown);

FIG. 18 is a front view thereof;

FIG. 19 is a right side view thereof;

FIG. 20 is a back view thereof;

FIG. 21 is a left side view thereof;

FIG. 22 is a top view thereof; and,

FIG. 23 is a bottom view thereof.

1 Claim, 4 Drawing Sheets

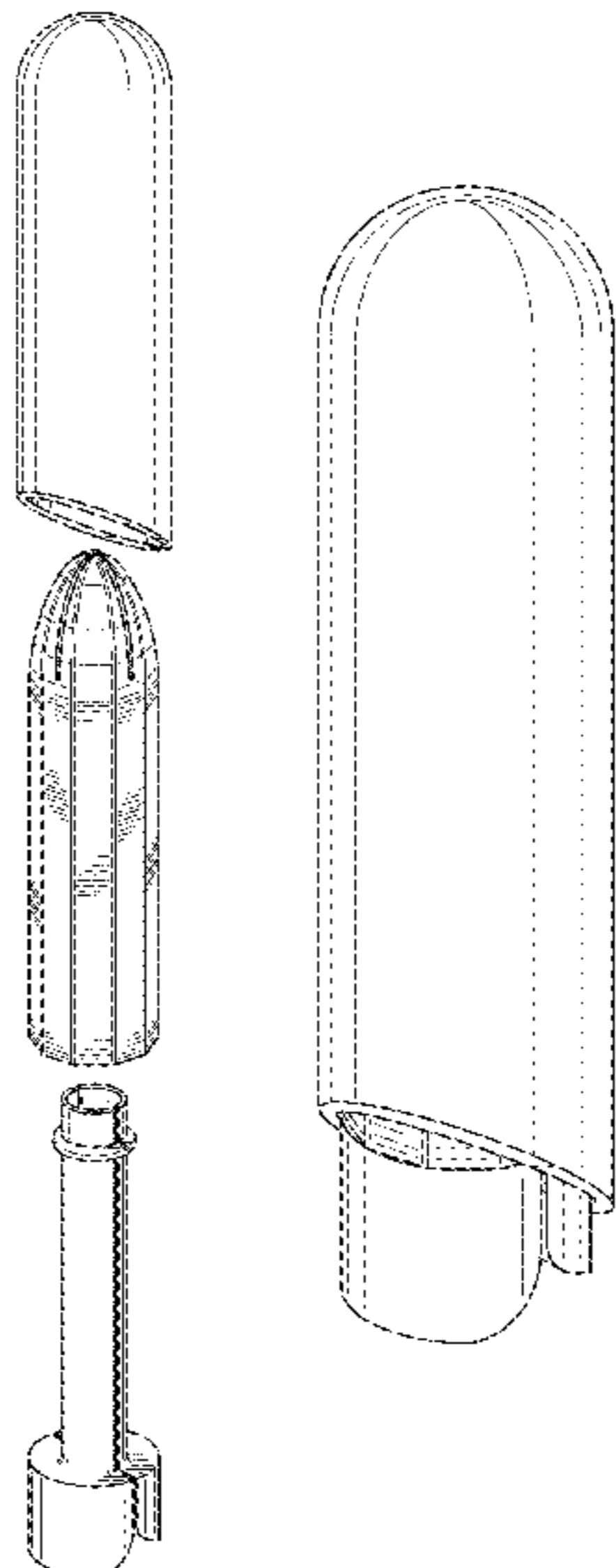

(56)

References Cited

U.S. PATENT DOCUMENTS

D222,013 S * 9/1971 Thomas D24/141
 3,895,634 A 7/1975 Berger et al.
 D250,049 S 10/1978 Hite
 D250,663 S 12/1978 Koch et al.
 4,148,317 A 4/1979 Loyer
 4,276,881 A * 7/1981 Lilaonitkul 604/14
 4,286,595 A * 9/1981 Ring 604/16
 5,300,075 A * 4/1994 Gordon D24/127
 5,385,542 A * 1/1995 Rawlings 604/14
 5,389,068 A * 2/1995 Keck 604/15
 D415,565 S 10/1999 Hayes et al.
 D427,424 S 7/2000 Conway
 D432,784 S 10/2000 Conway
 6,264,626 B1 * 7/2001 Linares et al. 604/15
 D477,075 S 7/2003 Schoelling
 D484,681 S 1/2004 Eldon et al.
 D515,212 S 2/2006 Edgett et al.
 D516,716 S 3/2006 Weber et al.
 D517,210 S 3/2006 Weber et al.
 7,044,928 B2 * 5/2006 LeMay et al. 604/15
 7,338,462 B2 * 3/2008 Minoguchi et al. 604/14
 D585,548 S 1/2009 Sargent et al.
 D612,940 S 3/2010 Edgett et al.
 D619,478 S 7/2010 Drewnowski et al.
 D626,650 S 11/2010 Edgett et al.

7,833,210 B2 * 11/2010 Schoelling 604/11
 D647,612 S * 10/2011 Smet D24/125
 8,029,485 B2 10/2011 Jensen
 2011/0201992 A1 * 8/2011 Smet et al. 604/11
 2013/0281912 A1 * 10/2013 Mikhail 604/16
 2014/0155810 A1 6/2014 Buell

OTHER PUBLICATIONS

Beautydeals, "Sprayco Microban Tampon Case," website available at: <https://www.beautydeals.net/shop/details.html?id=13573> Accessed on Jul. 27, 2014.
 The Find, "Tampon holder case," website available at <http://www.thefind.com/family/info-tampon-holder-case> Accessed on Jul. 27, 2014.
 TBox, "Tampon Holder," website available at <http://tboxgirl.com/> Accessed on Jul. 27, 2014.
 Kosmetik, "Lipstick holder tampon case," website available at <http://mocoloco.com/art/archives/005969.php> Accessed on Jul. 27, 2014.
 Tampax, "Tampax Tampons," website available at: <http://www.tampax.com/en-us/products/pearl/tampax-pearl-active-regular-tampons.aspx> Accessed on Jul. 27, 2014.
 Playtex, "Tampon guide," website available at <http://www.playtexplayon.com/first-time-users/how-to-use> Accessed on Jul. 27, 2014.

* cited by examiner

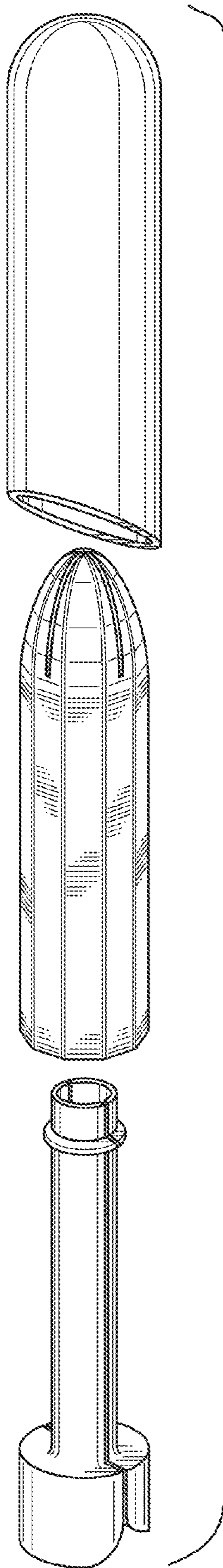

Fig. 1

Fig. 2

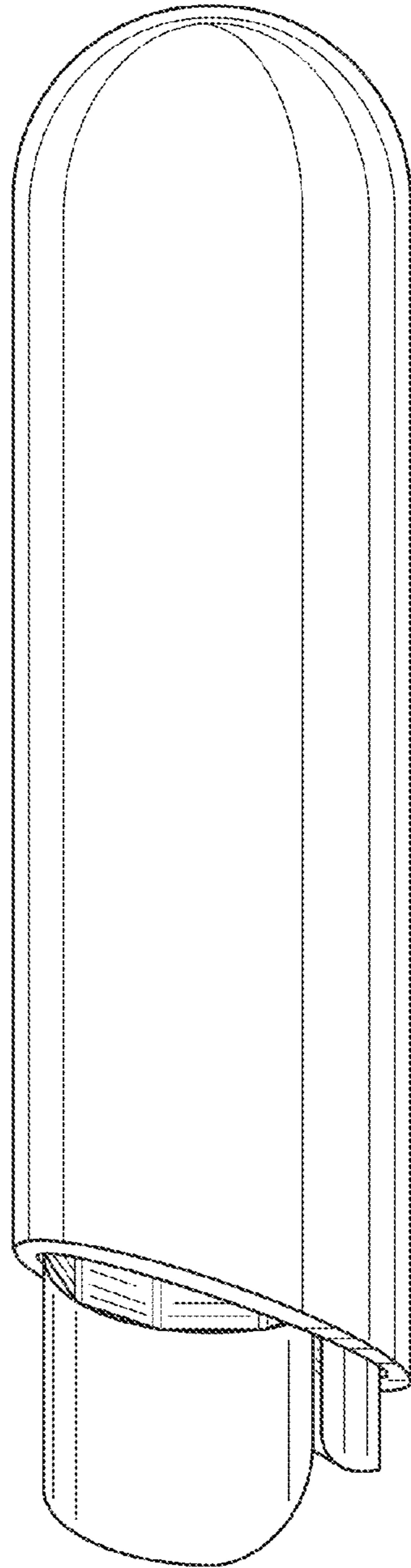

Fig. 3

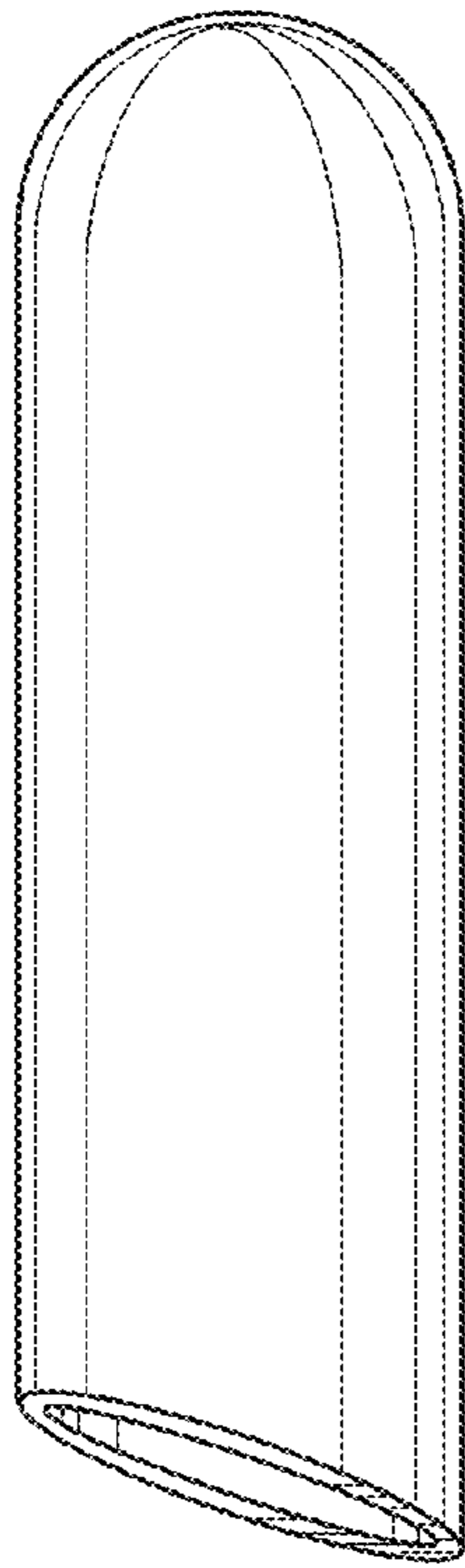

Fig. 4

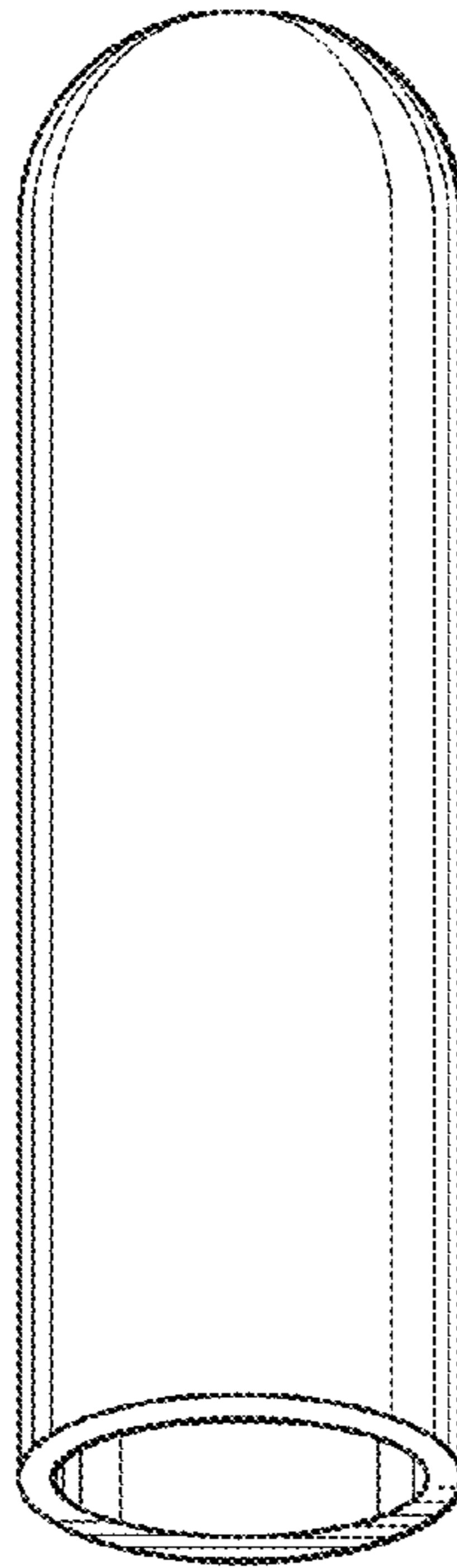

Fig. 5

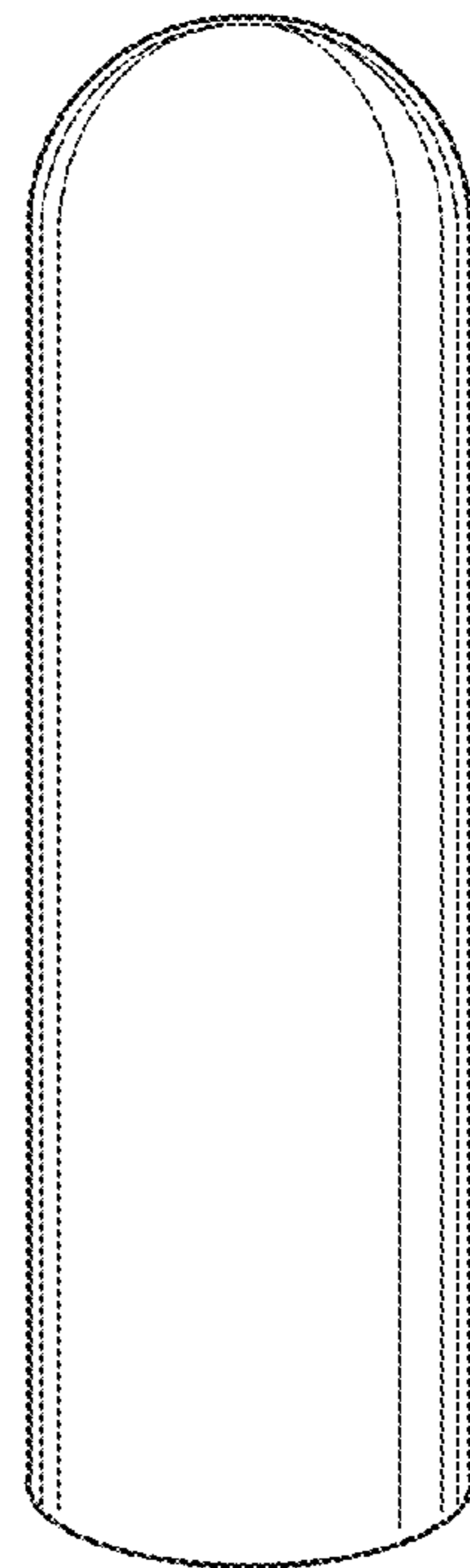

Fig. 6

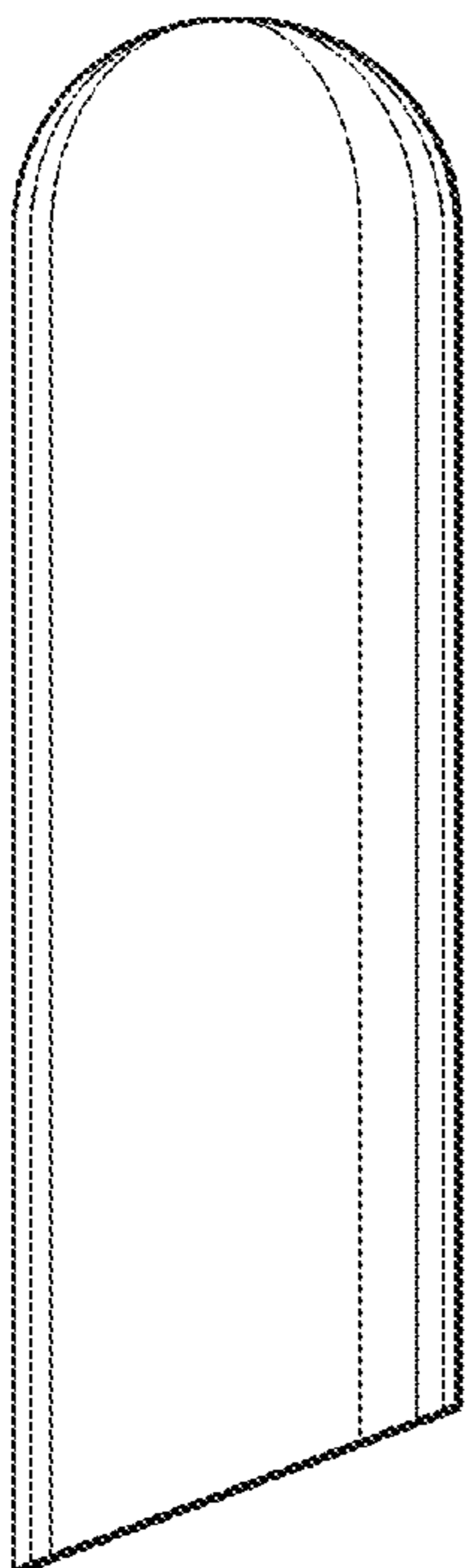

Fig. 7

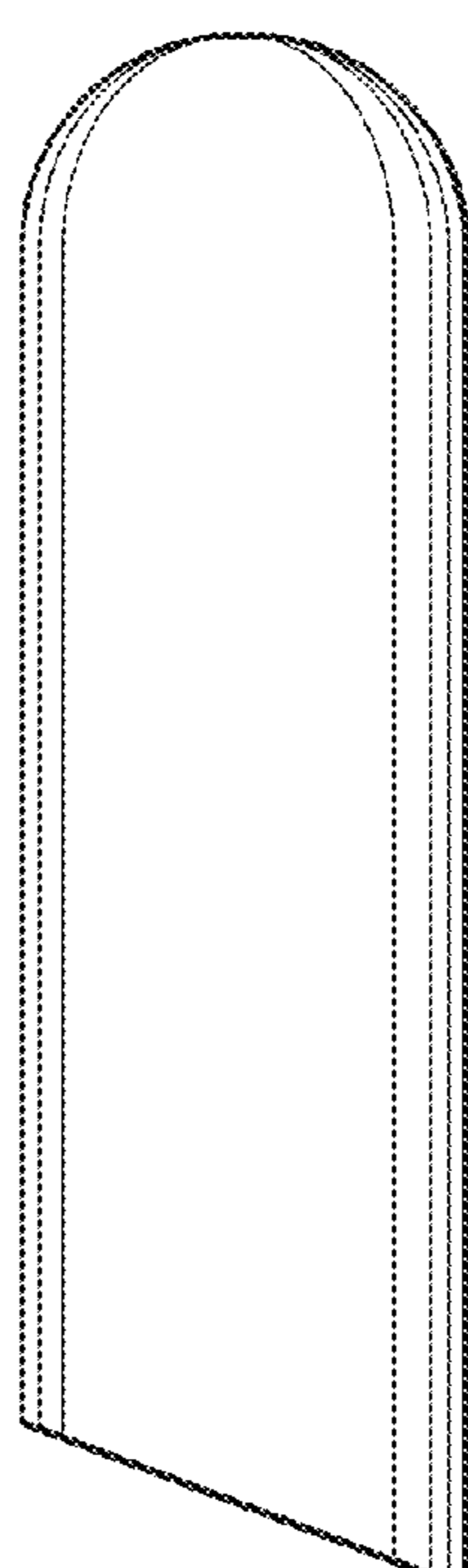

Fig. 8

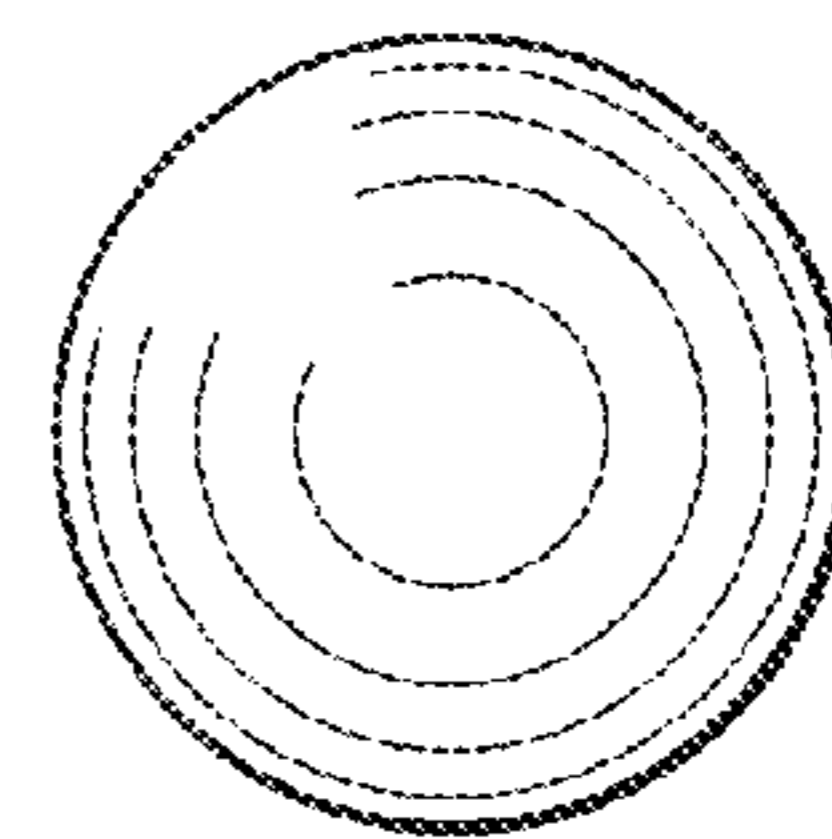

Fig. 9

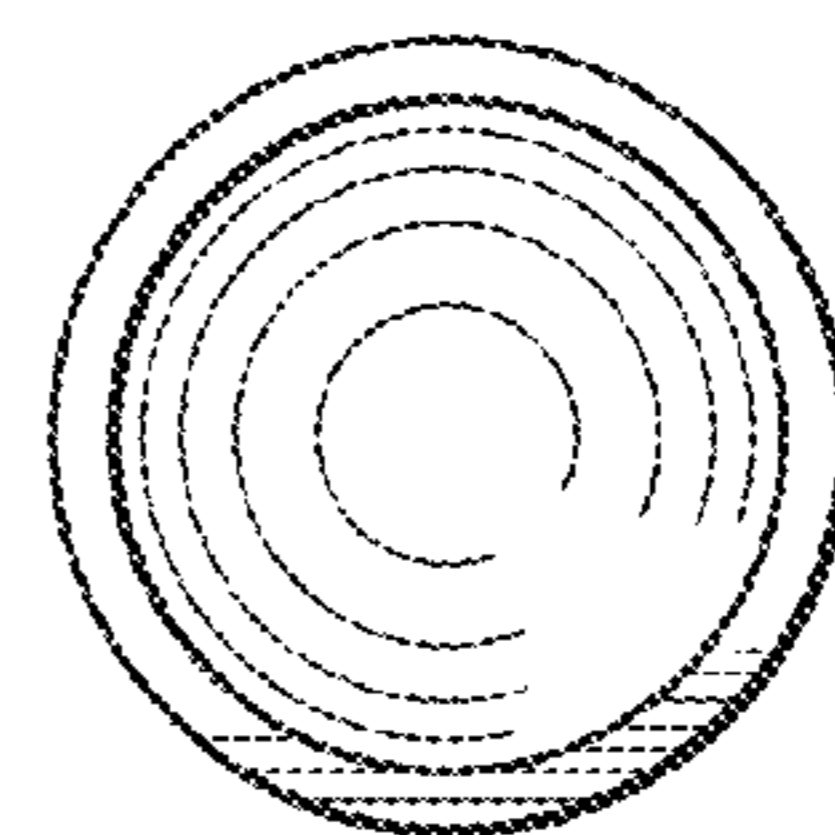

Fig. 10

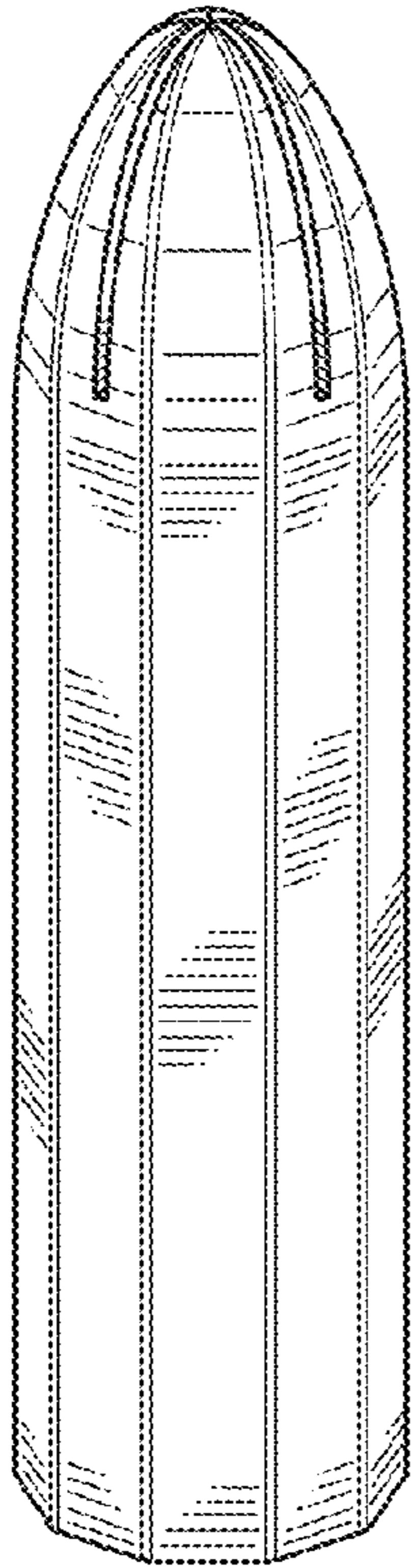

Fig. 11

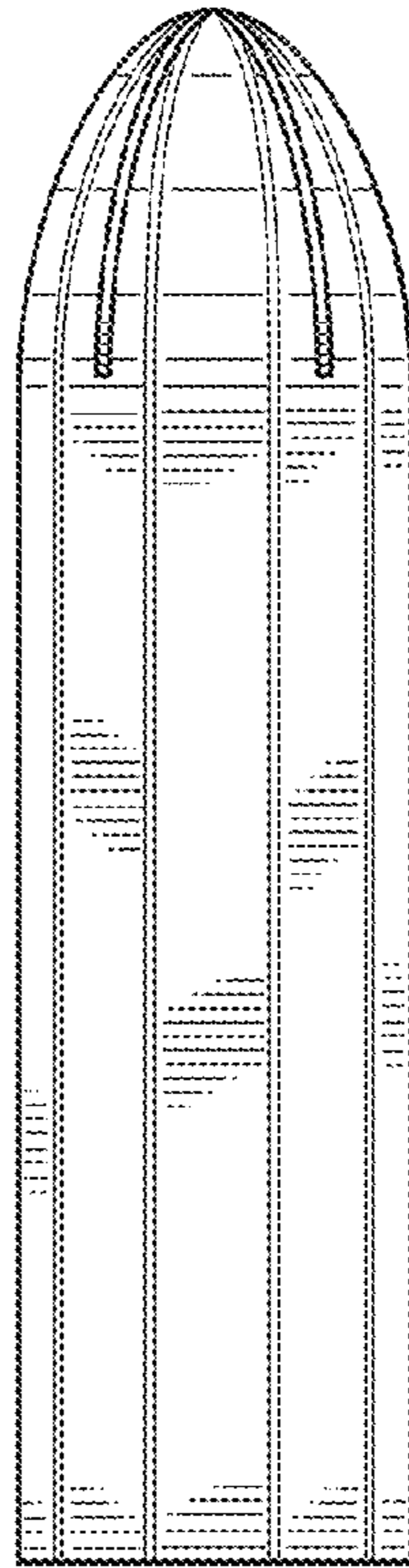

Fig. 12

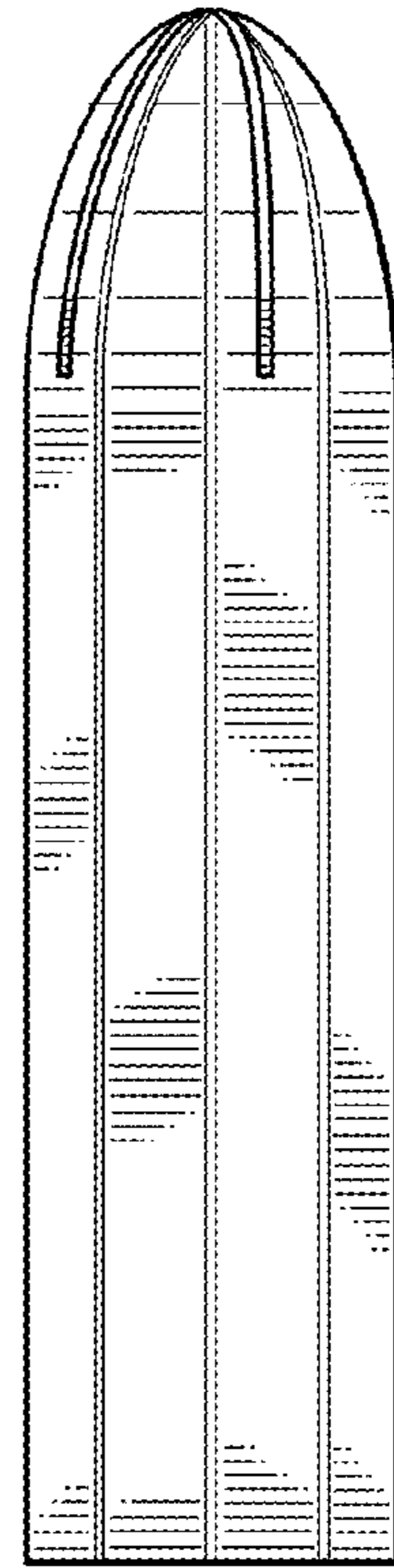

Fig. 13

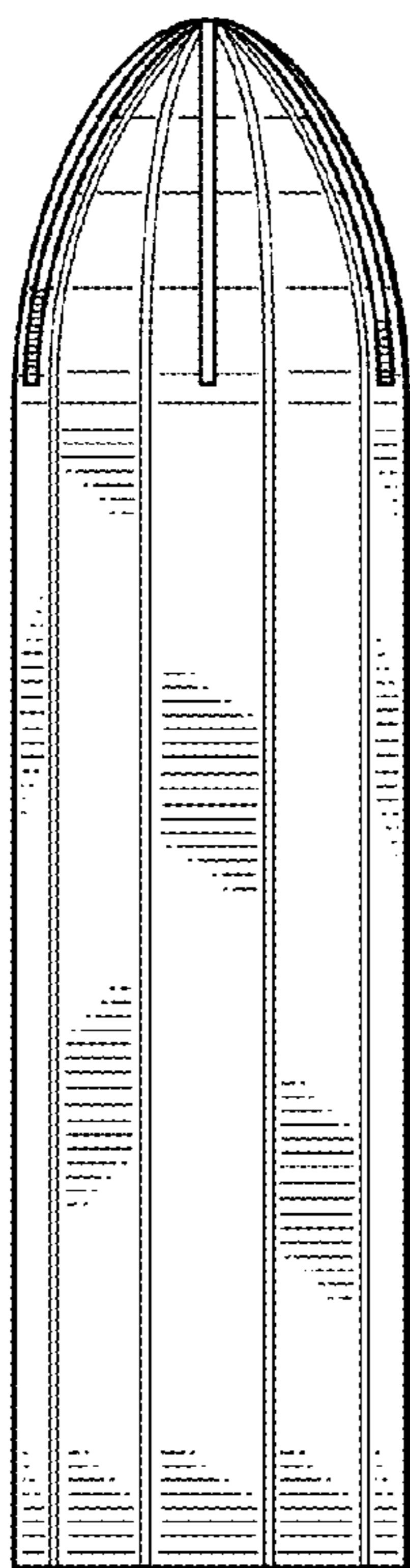

Fig. 14

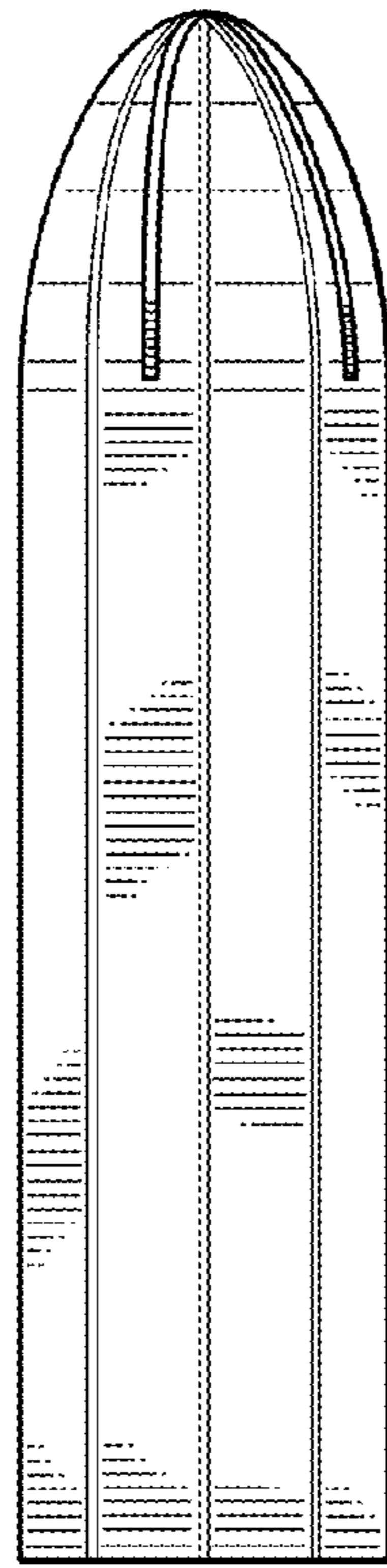

Fig. 15

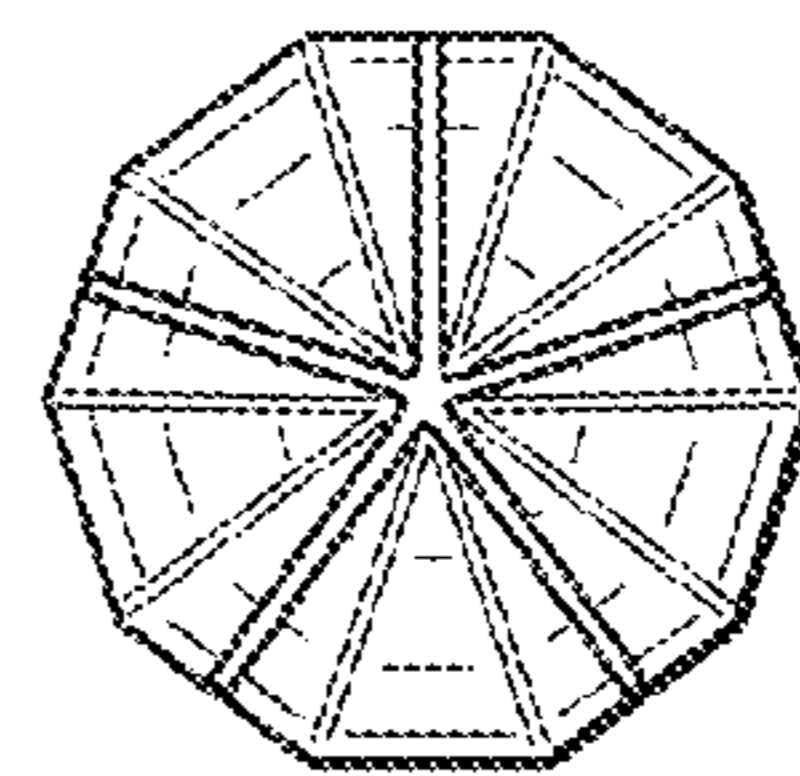

Fig. 16

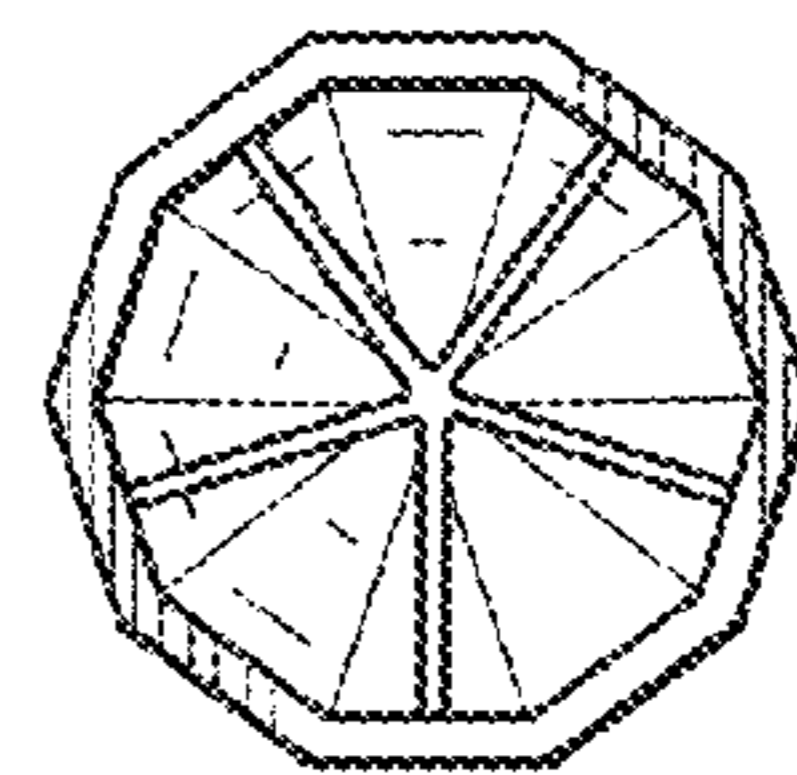

Fig. 17

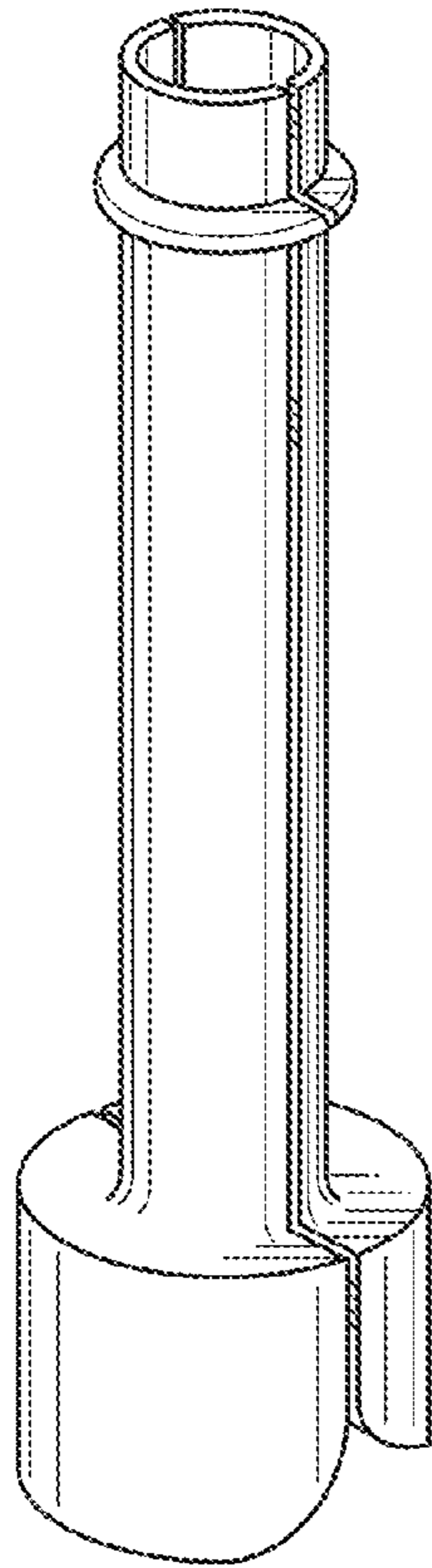

Fig. 18

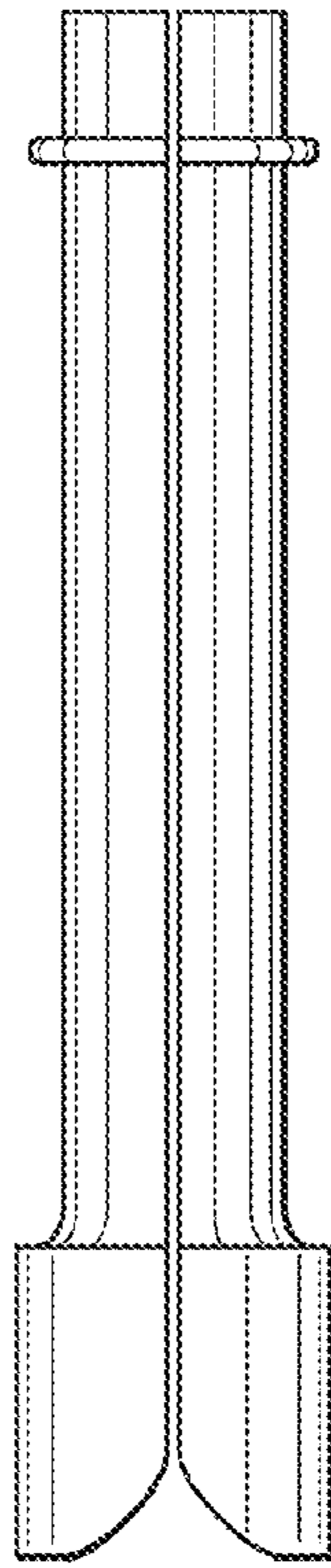

Fig. 19

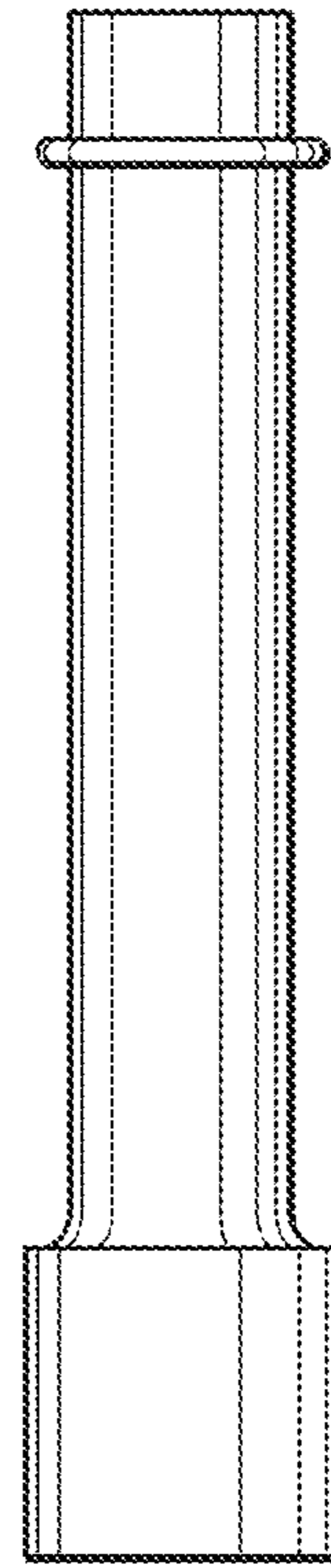

Fig. 20

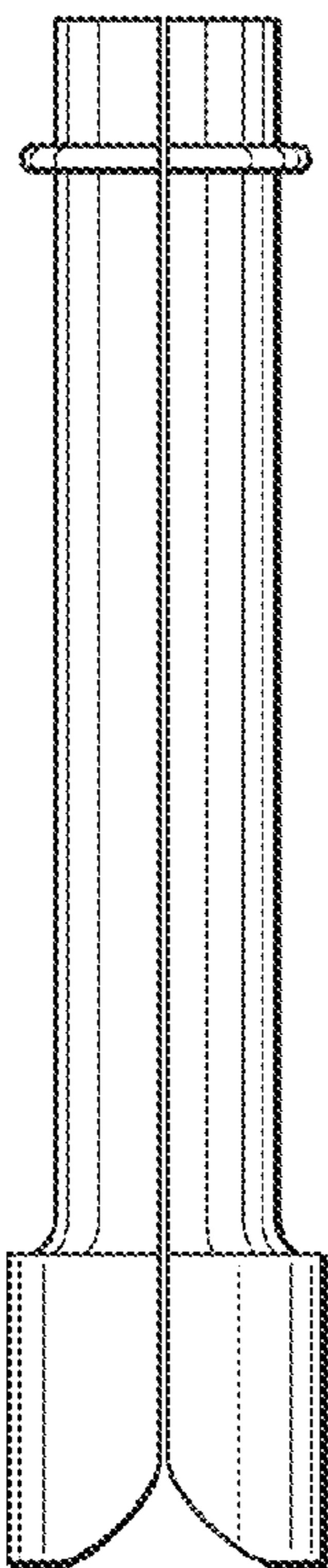

Fig. 21

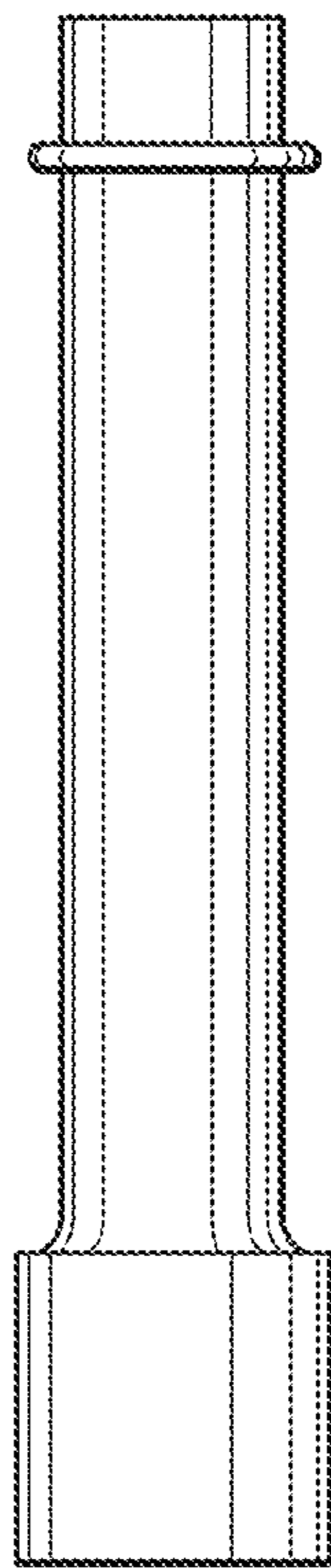

Fig. 22

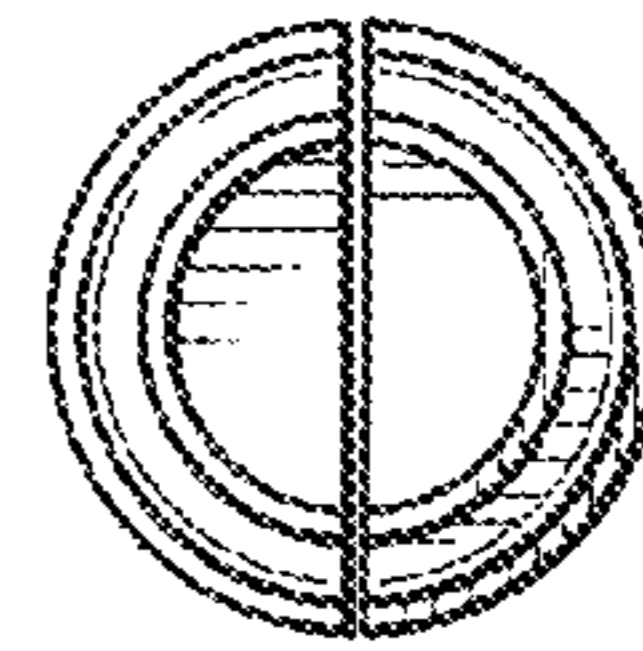

Fig. 23

