



US00D717871S

(12) **United States Design Patent**
Wamble

(10) **Patent No.:** **US D717,871 S**

(45) **Date of Patent:** **** *Nov. 18, 2014**

(54) **SIGN WITH INDIVIDUALIZED LETTERS AND SYMBOL**

(71) Applicant: **Architectural Safety Components, LLC**, Houston, TX (US)
(72) Inventor: **Mark Scott Wamble**, Houston, TX (US)
(73) Assignee: **Architectural Safety Components, LLC**, Houston, TX (US)

(*) Notice: This patent is subject to a terminal disclaimer.

(**) Term: **14 Years**

(21) Appl. No.: **29/464,067**

(22) Filed: **Aug. 12, 2013**

(51) **LOC (10) Cl.** **20-03**

(52) **U.S. Cl.**
USPC **D20/12; D20/42**

(58) **Field of Classification Search**
CPC G09F 13/00; G09F 13/04; G09F 13/0404; G09F 13/0413; G09F 13/20; G09F 13/26; G09F 13/28; G09F 13/44; G09F 19/12; G09F 2013/00; G09F 2013/04; G09F 2013/0486; G09F 2013/0459; G09F 2013/222; G08B 7/062; G08B 7/04; G08B 7/066
USPC D20/10, 12, 19, 39-42, 99; 40/446, 40/447, 452, 538-542, 545, 549, 552, 570, 40/576, 584, 594, 596, 600, 606.18, 617; D10/109.1, 109.2, 113.4; 362/559, 812
See application file for complete search history.

(56) **References Cited**

U.S. PATENT DOCUMENTS

D242,087	S	*	10/1976	Reeves	D20/42
D555,738	S	*	11/2007	Goldberg et al.	D20/42
D611,547	S	*	3/2010	Mirica et al.	D20/42
D625,363	S	*	10/2010	Lee	D20/42
D659,194	S	*	5/2012	Hetrick	D20/42
8,341,859	B2	*	1/2013	Culiver et al.	40/606.01
2006/0225326	A1	*	10/2006	Robinson et al.	40/542
2010/0107462	A1	*	5/2010	Lee	40/546

* cited by examiner

Primary Examiner — Mary Ann Calabrese

(74) *Attorney, Agent, or Firm* — Hitchcock Evert LLP

(57) **CLAIM**

The ornamental design for a sign with individualized letters and symbol, as shown and described.

DESCRIPTION

FIG. 1 is a perspective view from the top of the sign with individualized letters and symbol;
FIG. 2 is a front view thereof;
FIG. 3 is a back view thereof;
FIG. 4 is a right side view thereof;
FIG. 5 is a left side view thereof;
FIG. 6 is a top view thereof; and,
FIG. 7 is a bottom view thereof.
The broken lines are for illustrative purposes only and form no part of the claimed design.

1 Claim, 6 Drawing Sheets

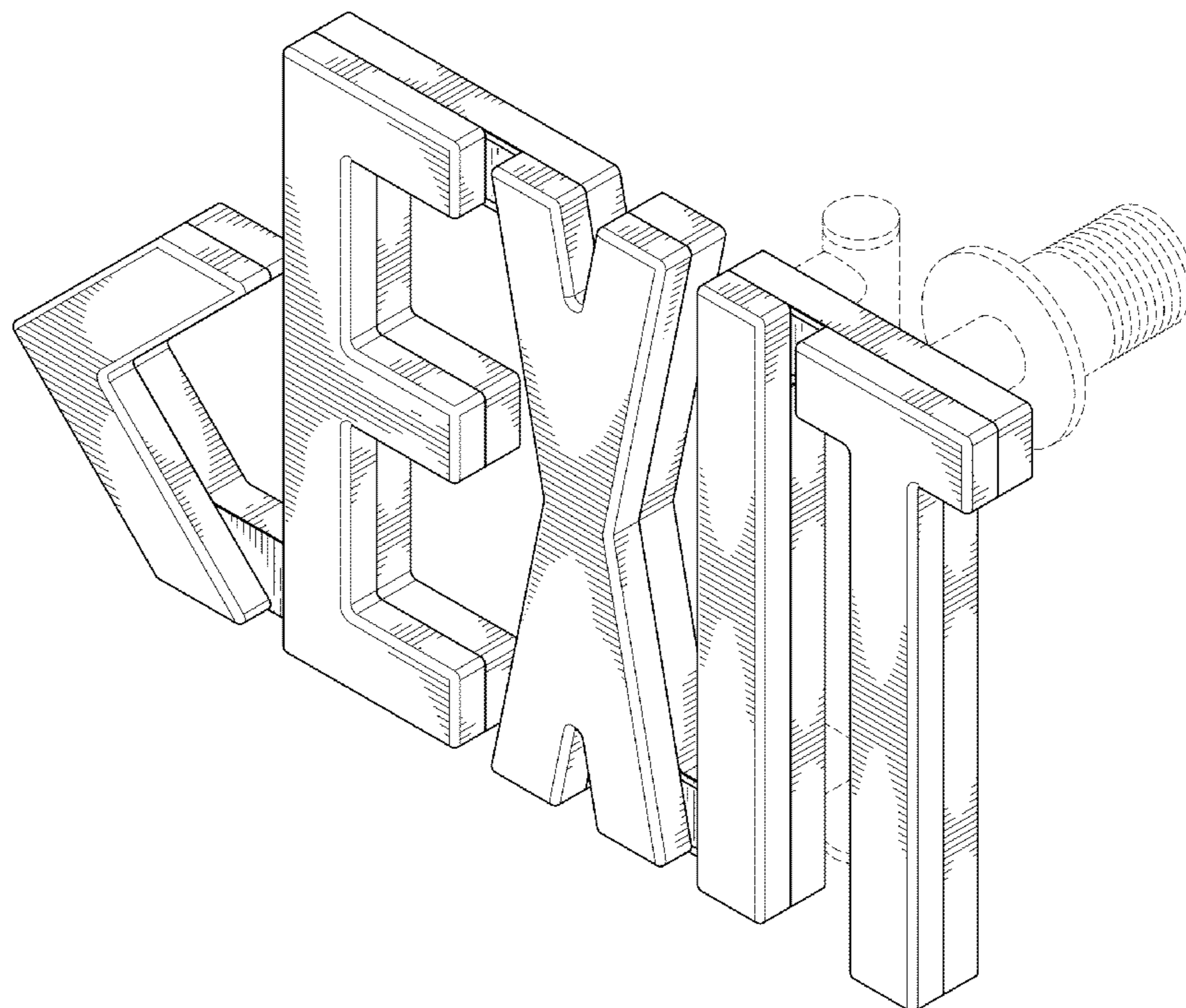

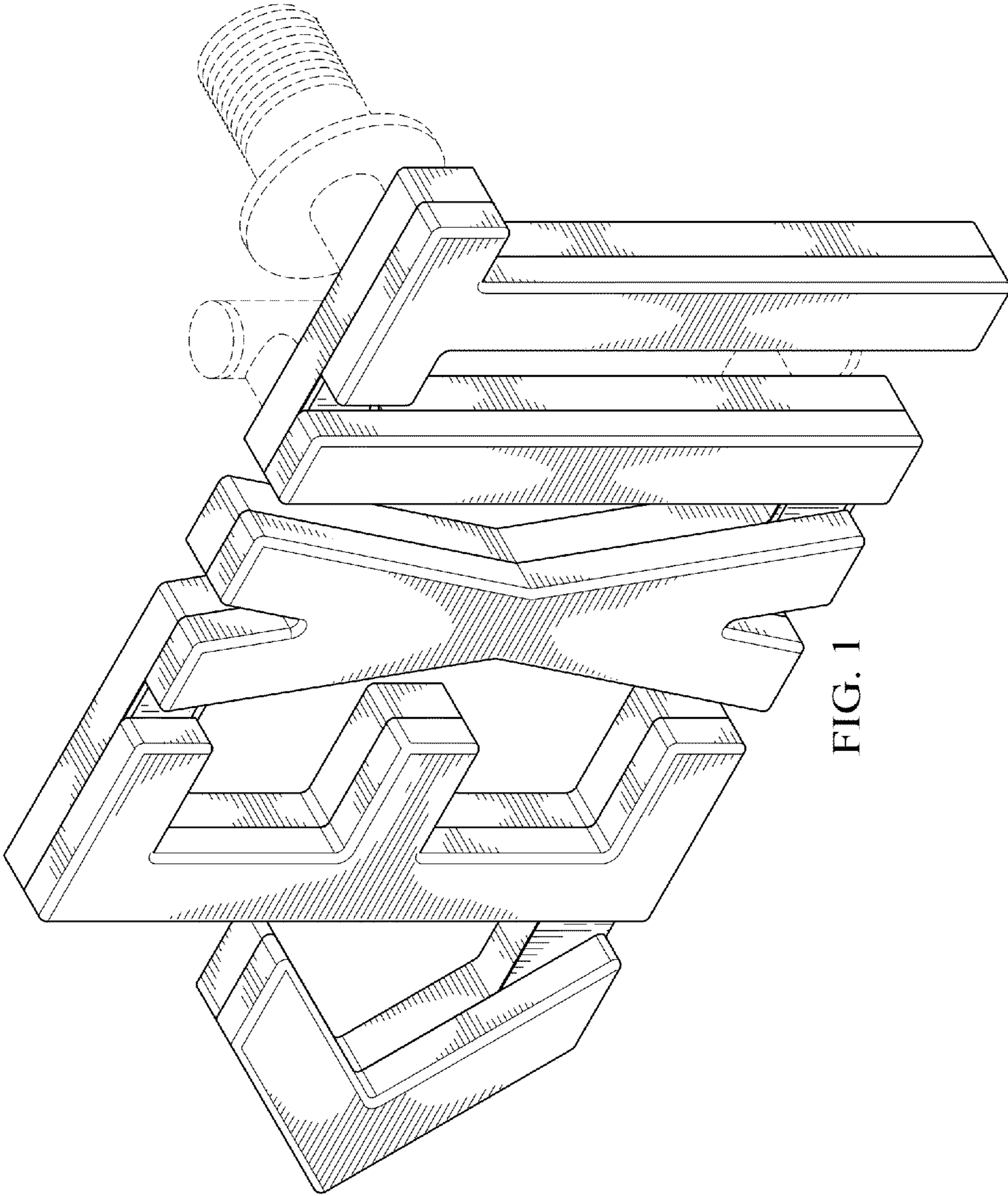

FIG. 1

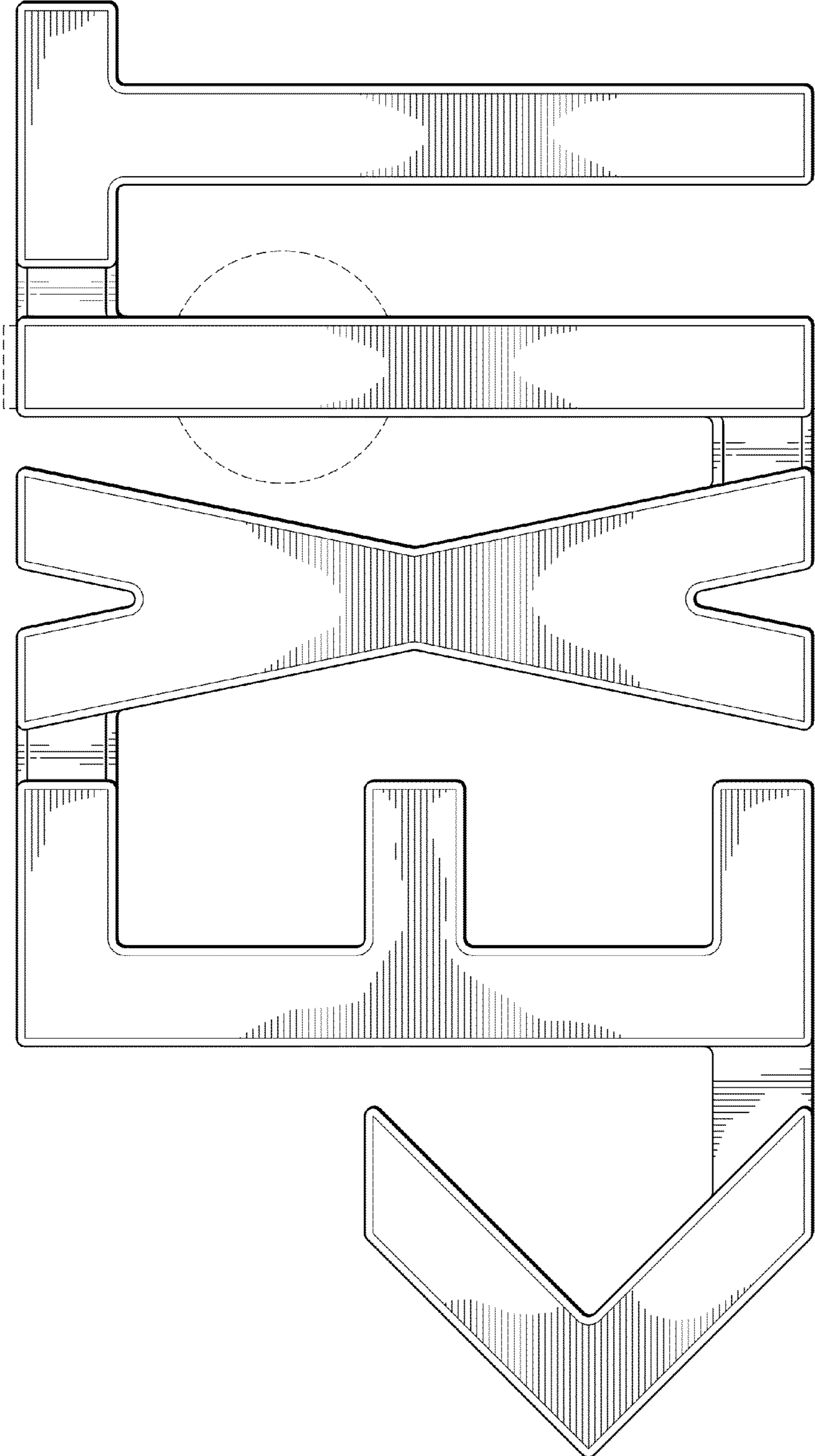

FIG. 2

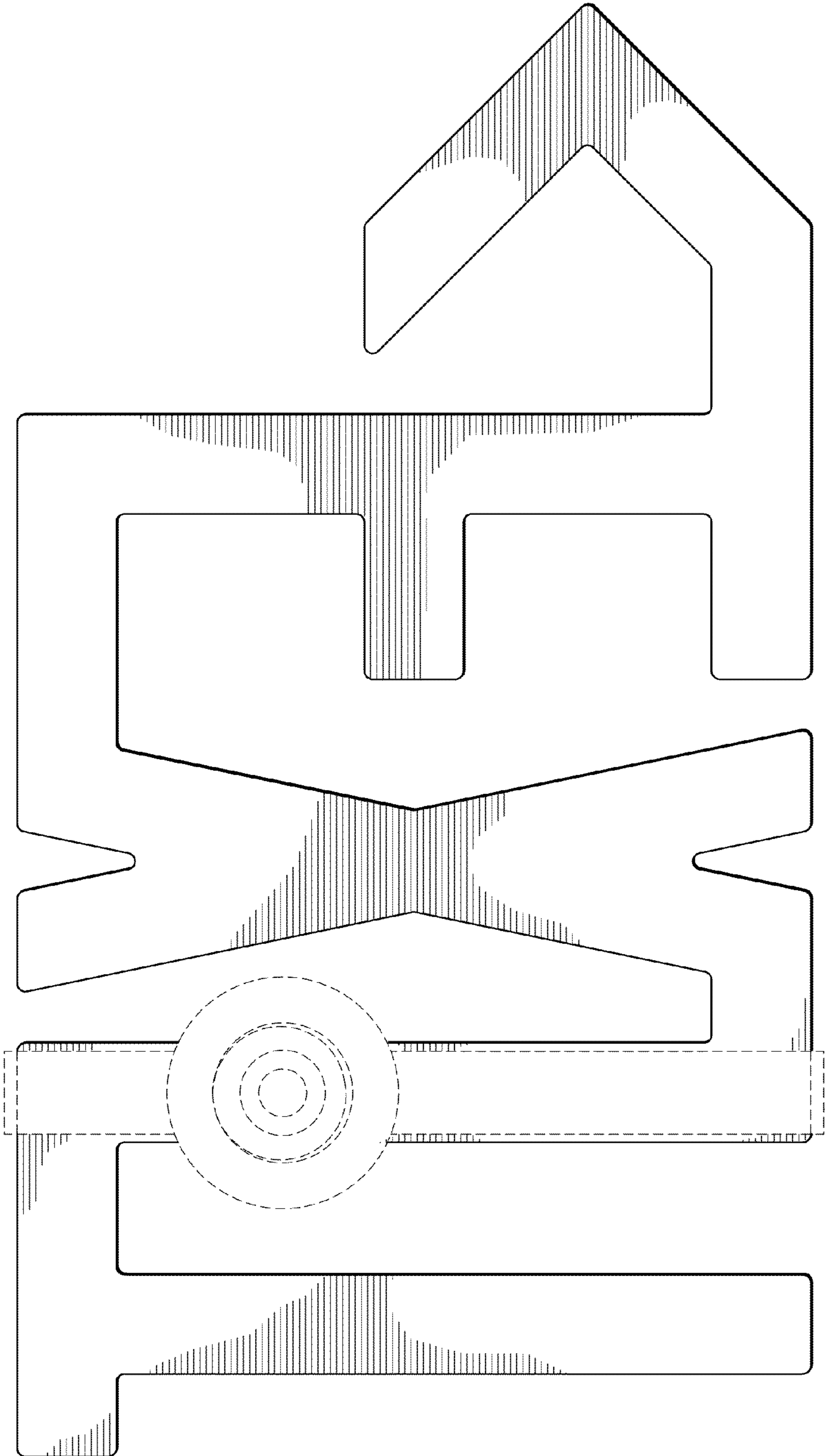

FIG. 3

FIG. 5

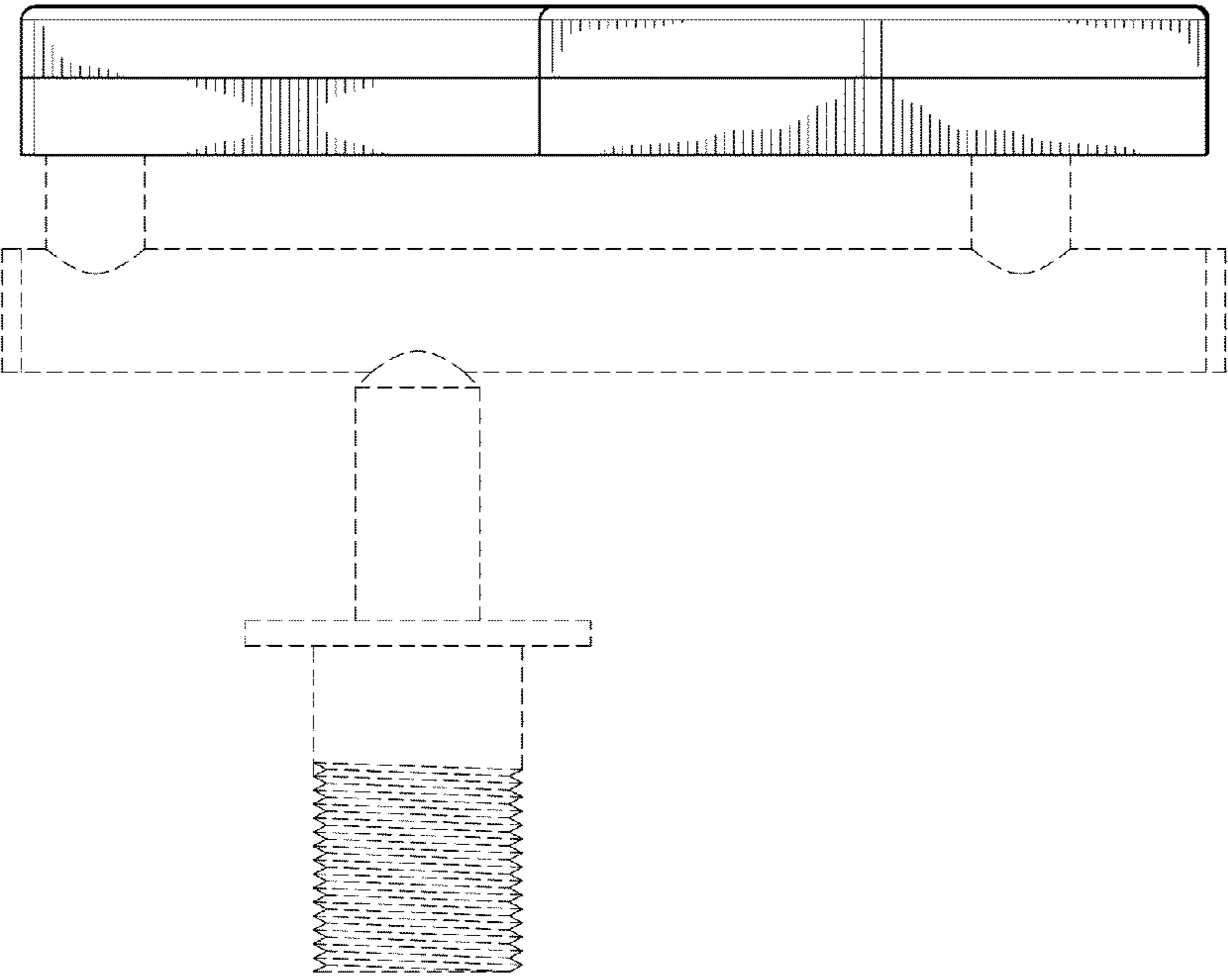

FIG. 4

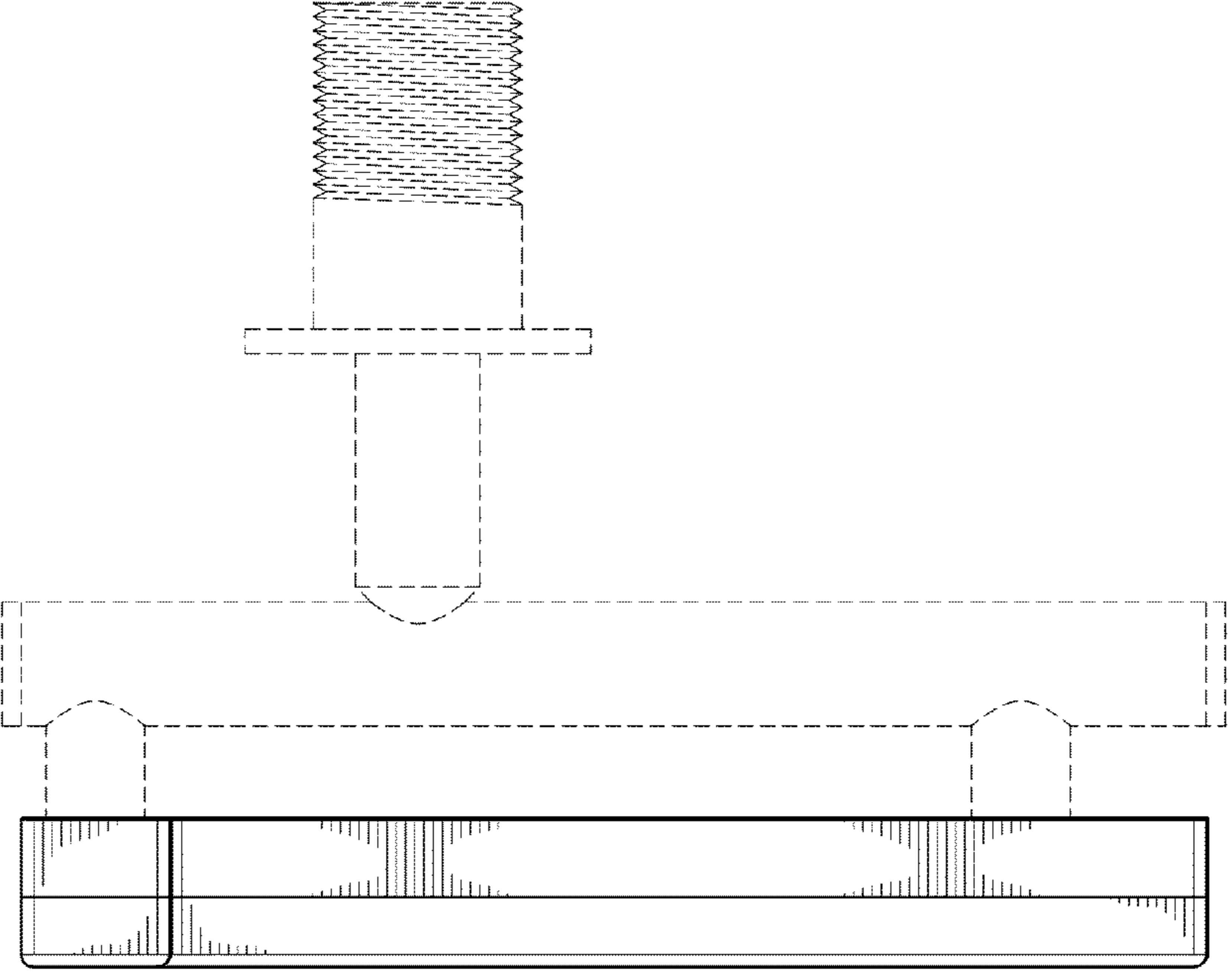
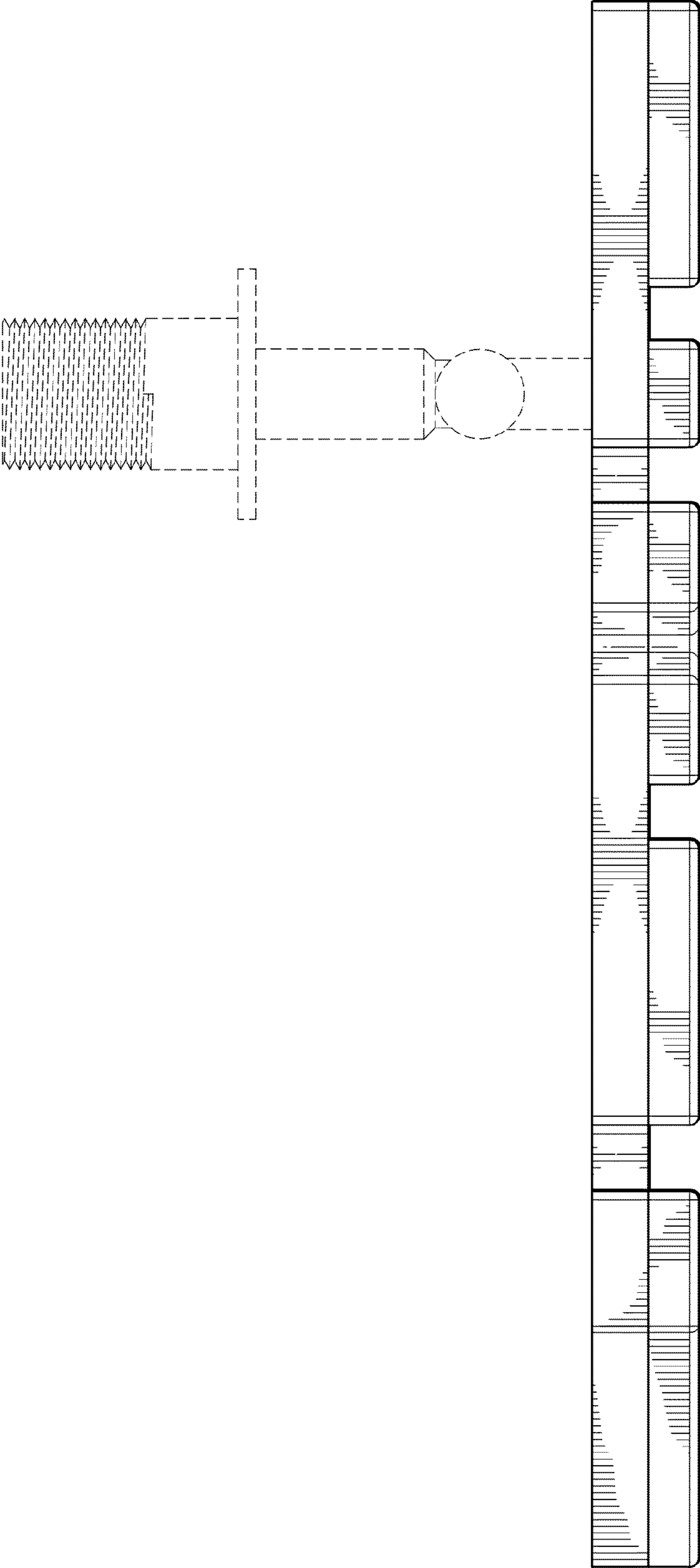

FIG. 6



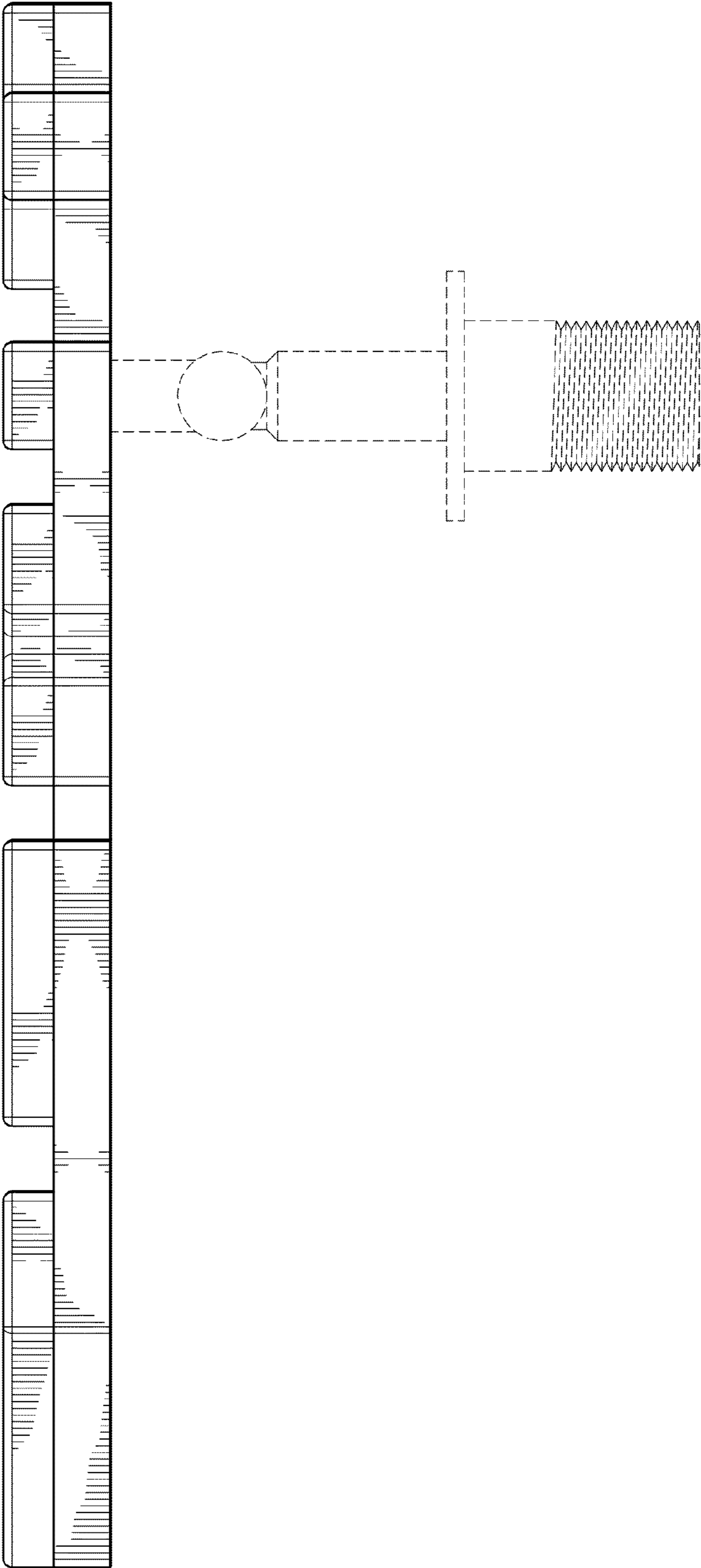

FIG. 7