



US00D717865S

(12) **United States Design Patent**  
**Votel et al.**

(10) **Patent No.:** **US D717,865 S**  
(45) **Date of Patent:** **\*\* Nov. 18, 2014**

(54) **PROTECTIVE EYEWEAR**

(71) Applicant: **Tenacious Holdings, Inc.**, St. Paul, MN (US)

(72) Inventors: **Thomas Votel**, Sunfish Lake, MN (US);  
**Andrew Olson**, Minneapolis, MN (US);  
**Dominique Aris**, Louisville, MN (US);  
**Gregory Schrab**, Shoreview, MN (US)

(73) Assignee: **Tenacious Holdings, Inc.**, St. Paul, MN (US)

(\*\*) Term: **14 Years**

(21) Appl. No.: **29/487,998**

(22) Filed: **Apr. 15, 2014**

(51) **LOC (10) Cl.** ..... **16-06**

(52) **U.S. Cl.**  
USPC ..... **D16/326**; D16/335

(58) **Field of Classification Search**  
USPC ..... D16/101, 300–342, 900; D29/109–110;  
351/41, 44, 51–52, 62, 158, 92,  
351/103–123, 140–153, 63, 59, 45–46;  
2/426–432, 447–449, 441, 434–437,  
2/13, 15; D21/483, 659–661; D14/372

See application file for complete search history.

(56) **References Cited**

U.S. PATENT DOCUMENTS

D534,573	S	*	1/2007	Mage	.....	D16/326
D557,730	S	*	12/2007	Mage	.....	D16/326
D561,813	S	*	2/2008	Baden et al.	.....	D16/325
D594,052	S	*	6/2009	Yang	.....	D16/326
D602,978	S	*	10/2009	Mage	.....	D16/326
D606,113	S	*	12/2009	Daems et al.	.....	D16/326
D645,076	S	*	9/2011	Markovitz et al.	.....	D16/326
D654,530	S	*	2/2012	Markovitz et al.	.....	D16/326
D681,100	S	*	4/2013	Markovitz et al.	.....	D16/326
D697,548	S	*	1/2014	Earley	.....	D16/326

\* cited by examiner

*Primary Examiner* — Raphael Barkai

(74) *Attorney, Agent, or Firm* — Skaar Ulbrich Macari, P.A.

(57) **CLAIM**

We claim the ornamental design for protective eyewear, as shown and described.

**DESCRIPTION**

FIG. 1 is a perspective of our protective eyewear.  
FIG. 2 is a front elevation view thereof.  
FIG. 3 is a rear elevation view thereof.  
FIG. 4 is a top plan view thereof.  
FIG. 5 is a bottom plan view thereof; and,  
FIG. 6 is a side elevation view thereof.  
The broken lines in the drawings illustrate features of the article to which the design is applied that forms no part of the claim.

**1 Claim, 5 Drawing Sheets**

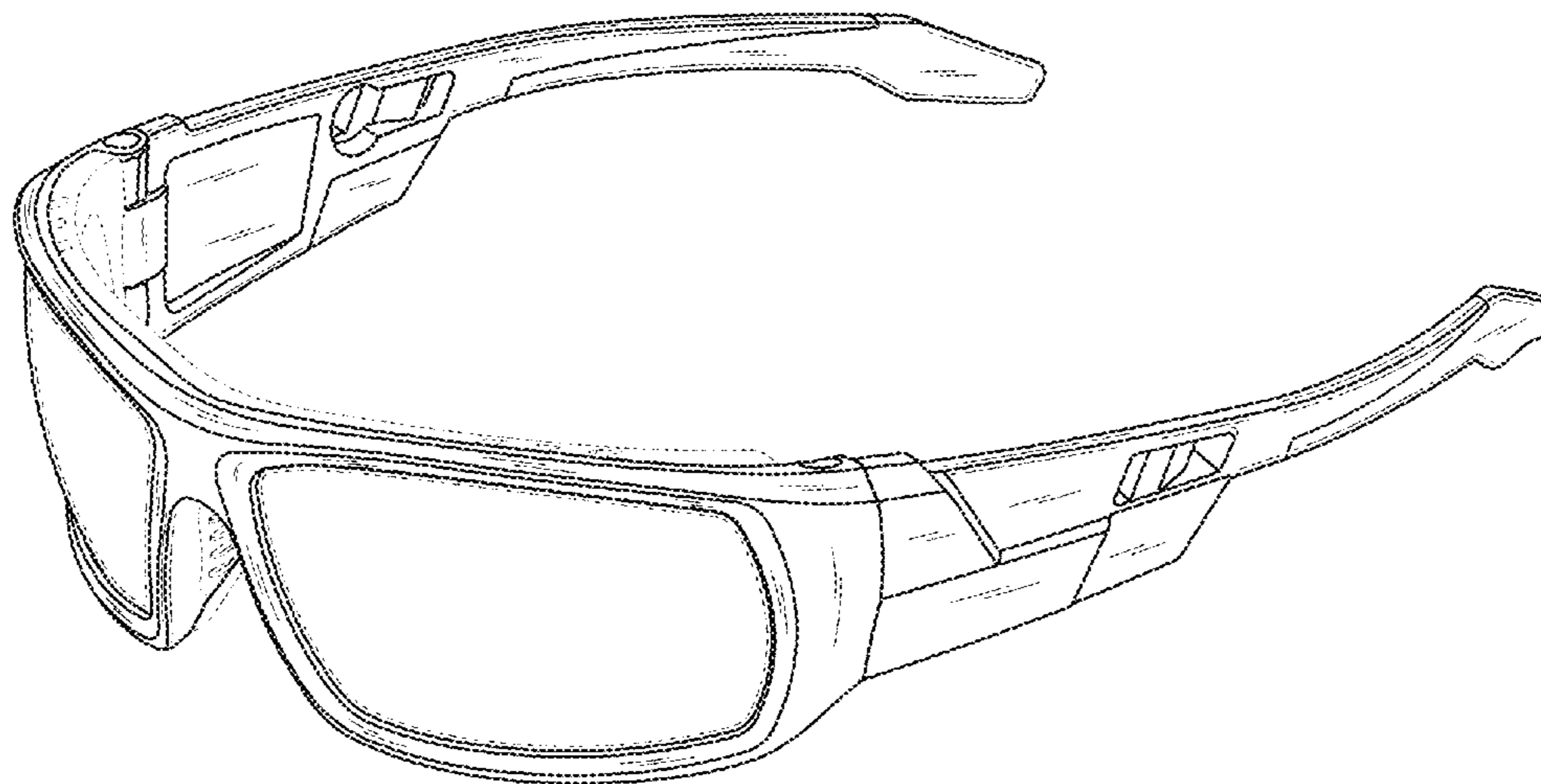

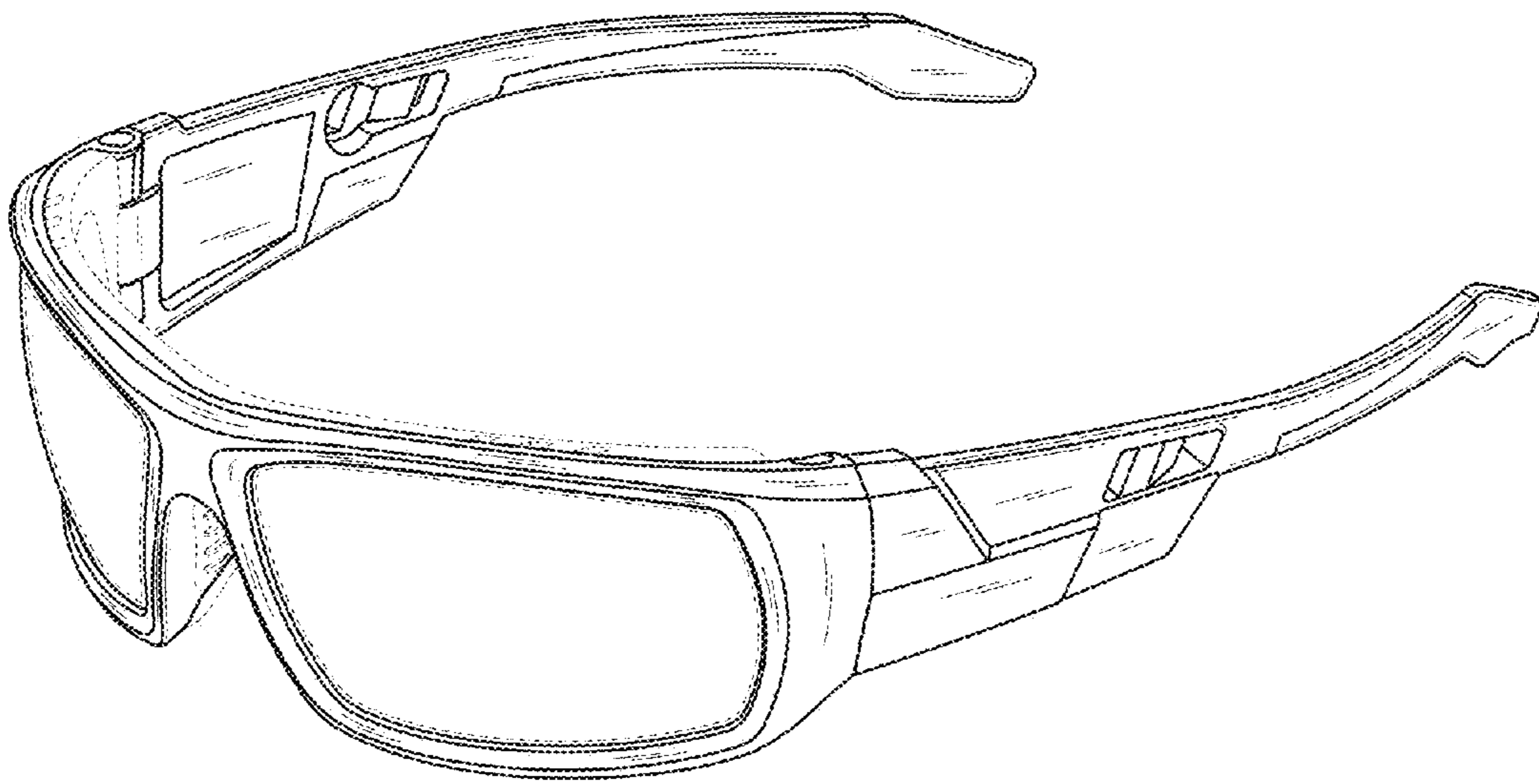
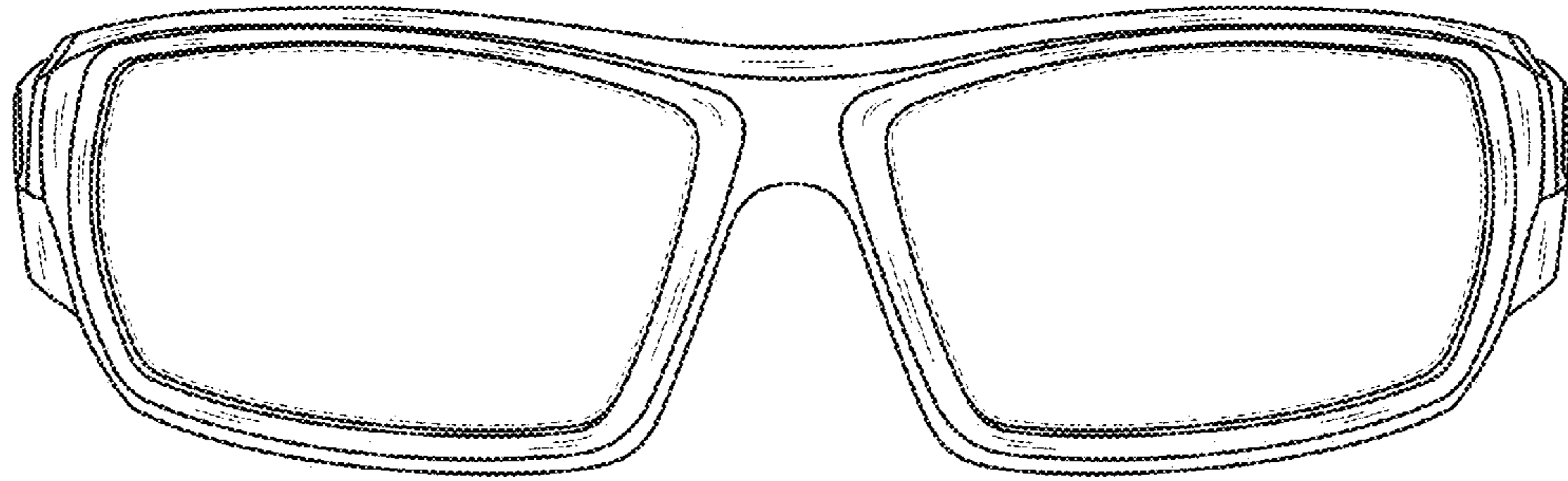
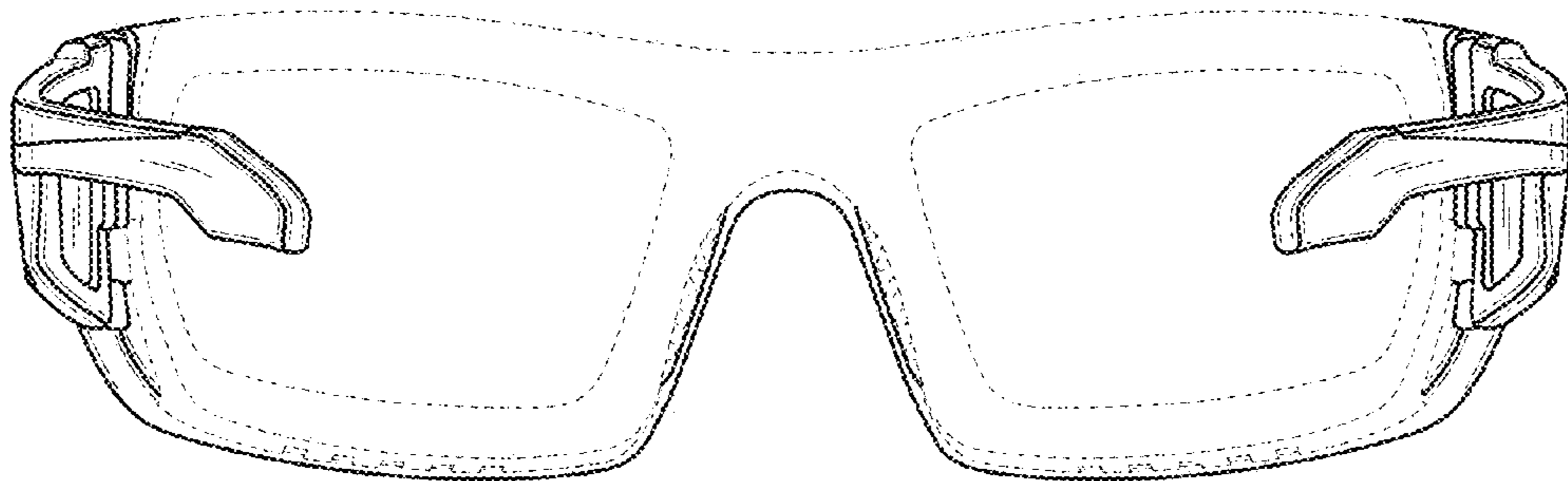

Fig. 1



**Fig. 2**



**Fig. 3**

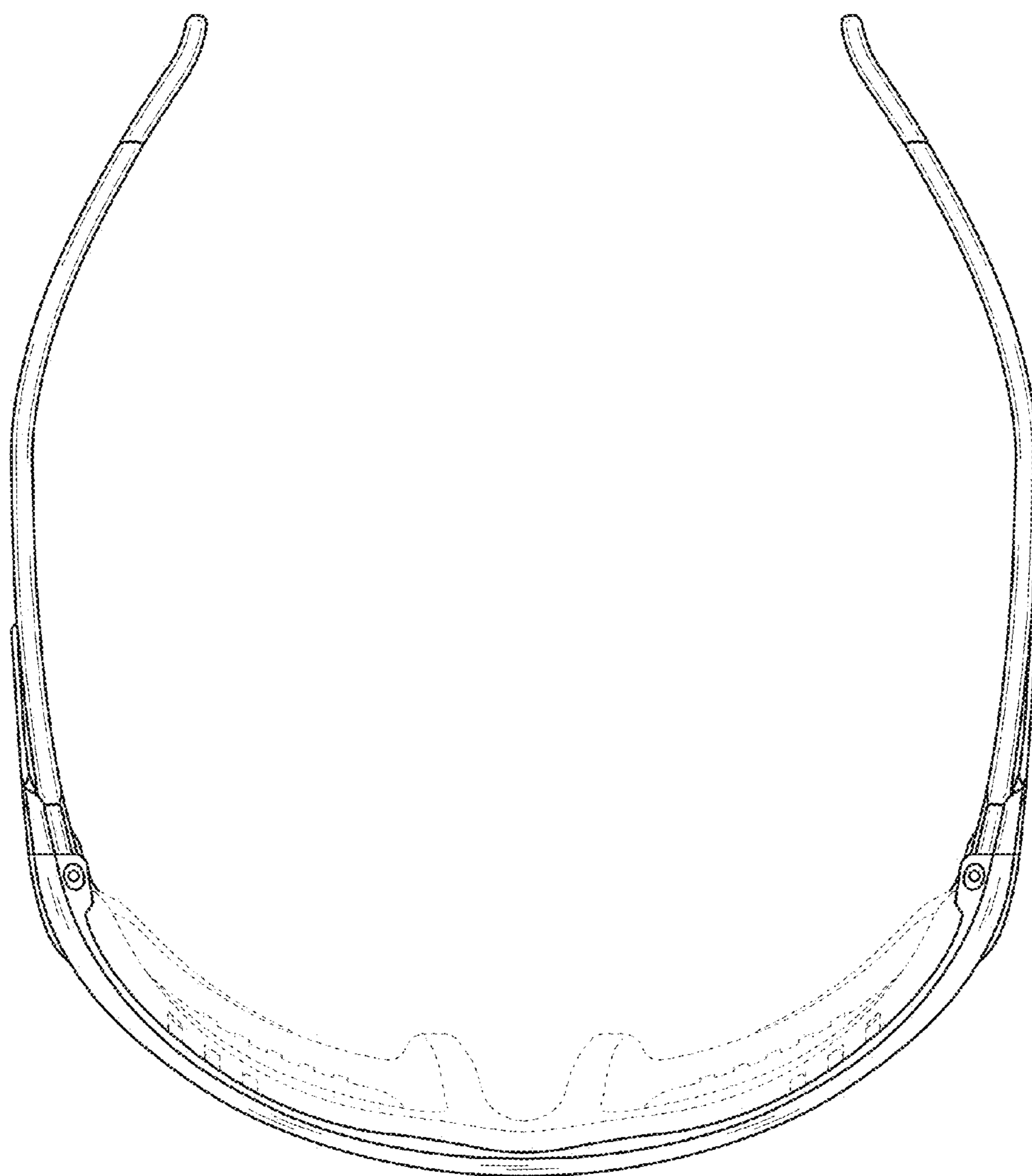

Fig. 4

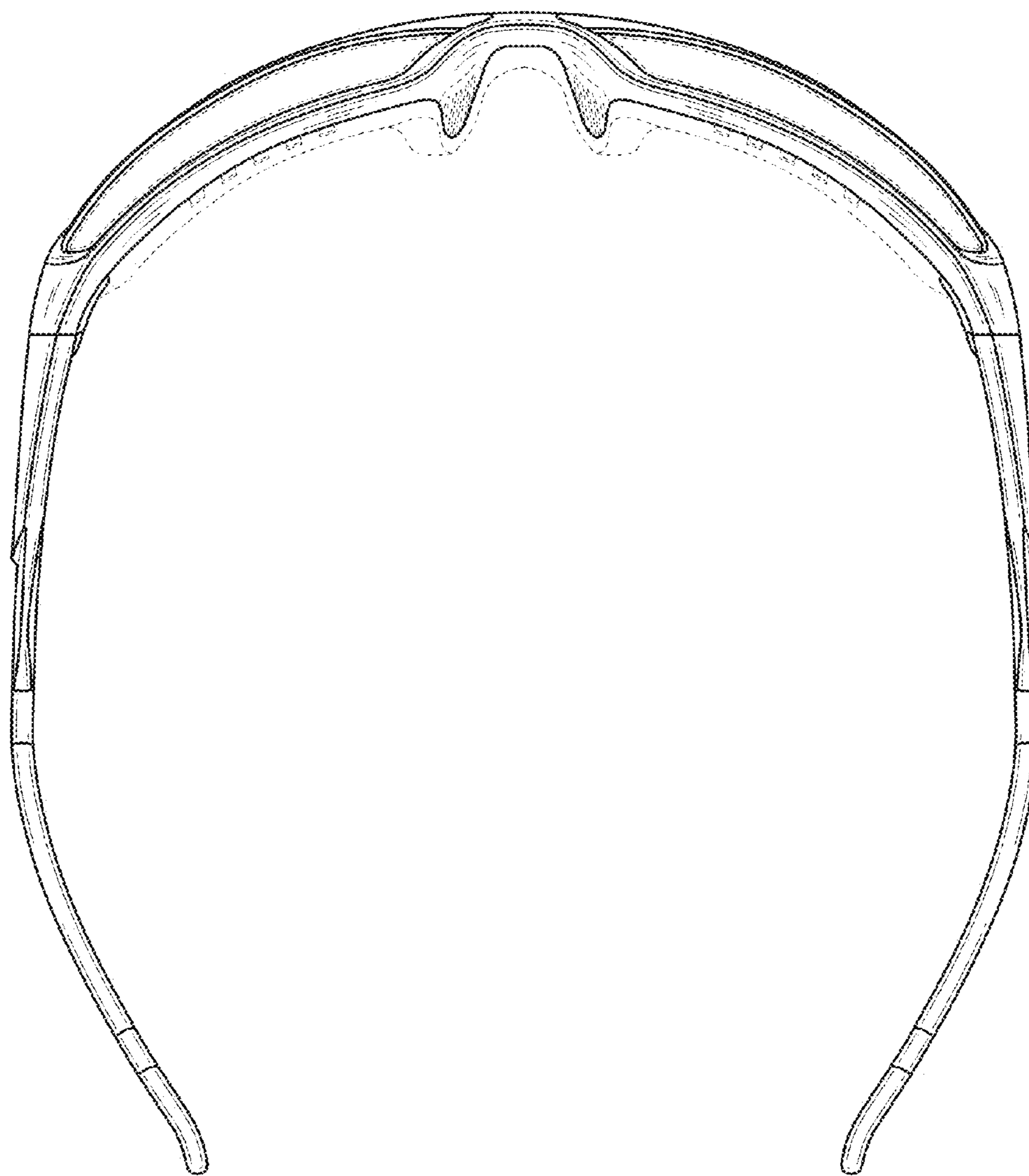

Fig. 5

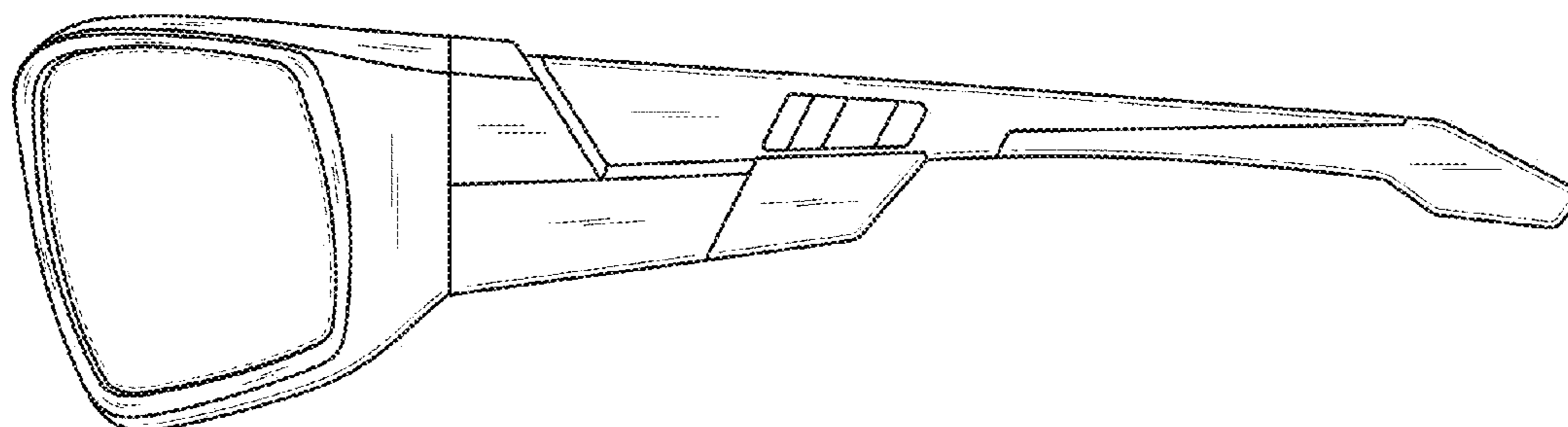

Fig. 6