



US00D717861S

(12) **United States Design Patent**
Chiang

(10) **Patent No.:** **US D717,861 S**

(45) **Date of Patent:** **** Nov. 18, 2014**

(54) **SWIMMING GOGGLES**

(71) Applicant: **Global Esprit Inc.**, New Taipei (TW)

(72) Inventor: **Herman Chiang**, New Taipei (TW)

(73) Assignee: **Global Esprit Inc.**, New Taipei (TW)

(**) Term: **14 Years**

(21) Appl. No.: **29/497,004**

(22) Filed: **Jul. 19, 2014**

(51) **LOC (10) Cl.** **14-03**

(52) **U.S. Cl.**
USPC **D16/303; D16/311**

(58) **Field of Classification Search**
CPC A63B 33/002
USPC D14/125-134, 239, 371, 136, 374-377,
D14/440, 450, 448, 336, 342, 159, 372;
312/7.2; D16/101, 300-342; 351/41,
351/44, 158; D10/15, 26; 446/484, 175,
446/356; D6/477, 479, 300; 2/426-430,
2/436-437, 440-452

See application file for complete search history.

(56) **References Cited**

U.S. PATENT DOCUMENTS

D483,053 S *	12/2003	Chiang	D16/303
D585,473 S *	1/2009	Chiang	D16/311
D633,549 S *	3/2011	Chiang	D16/303
D648,371 S *	11/2011	Chiang	D16/303
D658,702 S *	5/2012	Furniss et al.	D16/311

* cited by examiner

Primary Examiner — Raphael Barkai

(74) *Attorney, Agent, or Firm* — Cheng-Ju Chiang

(57) **CLAIM**

The ornamental design for swimming goggles, as shown and described.

DESCRIPTION

FIG. 1 is a perspective view of swimming goggles showing my new design;
FIG. 2 is a front elevational view thereof;
FIG. 3 is a rear elevational view thereof;
FIG. 4 is a left elevational view thereof;
FIG. 5 is a right elevational view thereof;
FIG. 6 is a top plan view thereof; and,
FIG. 7 is a bottom plan view thereof.

1 Claim, 4 Drawing Sheets

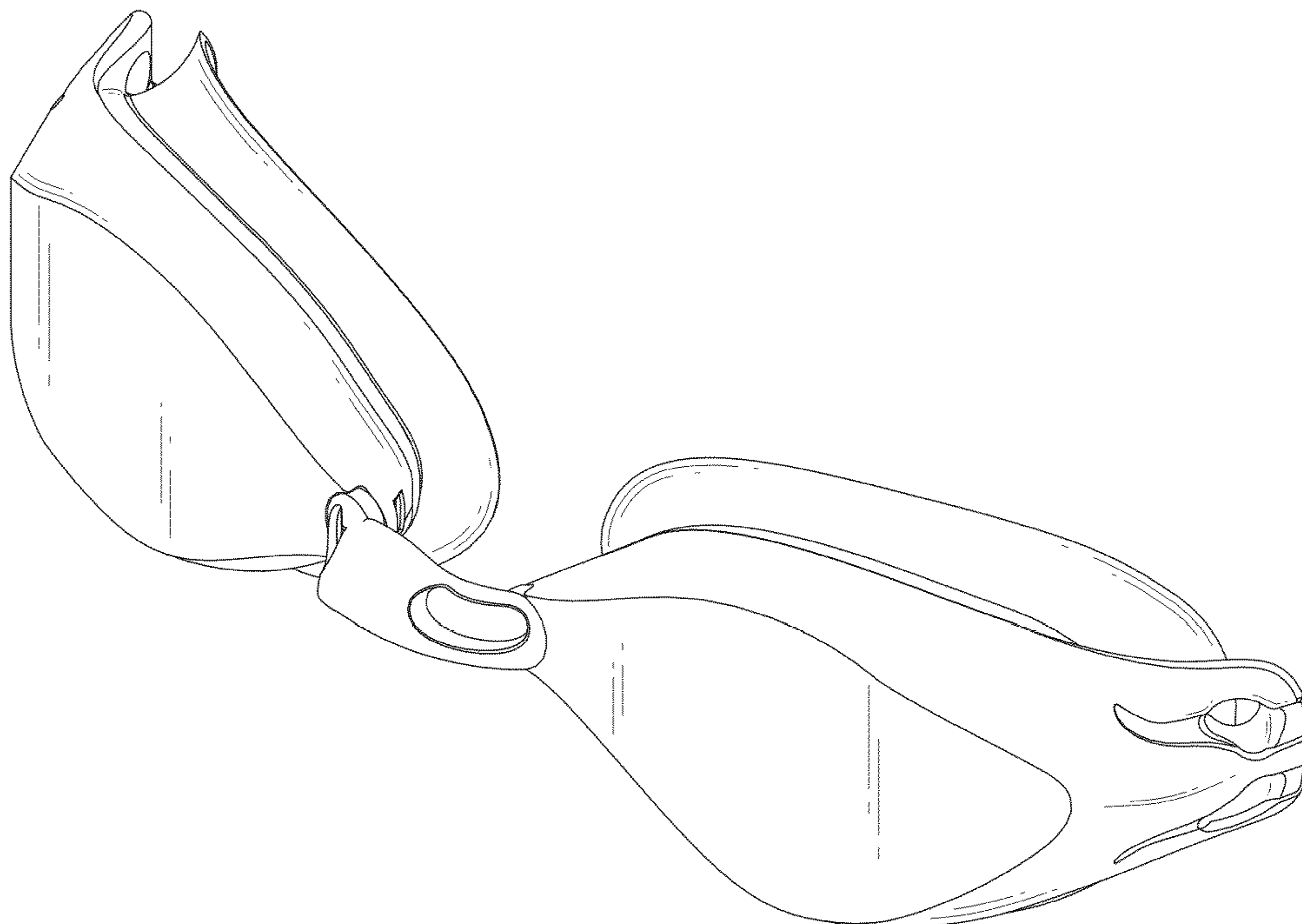

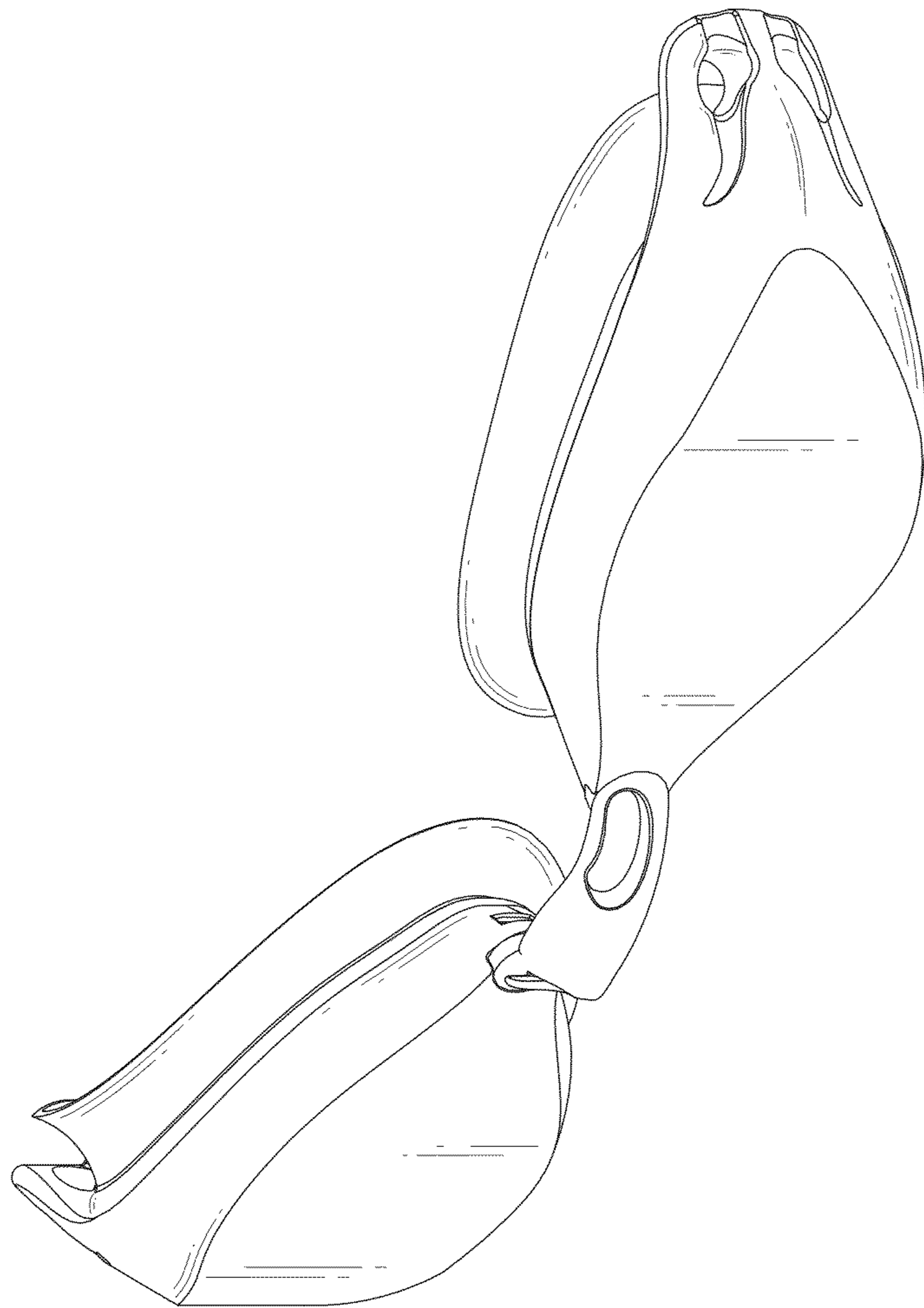

FIG.1

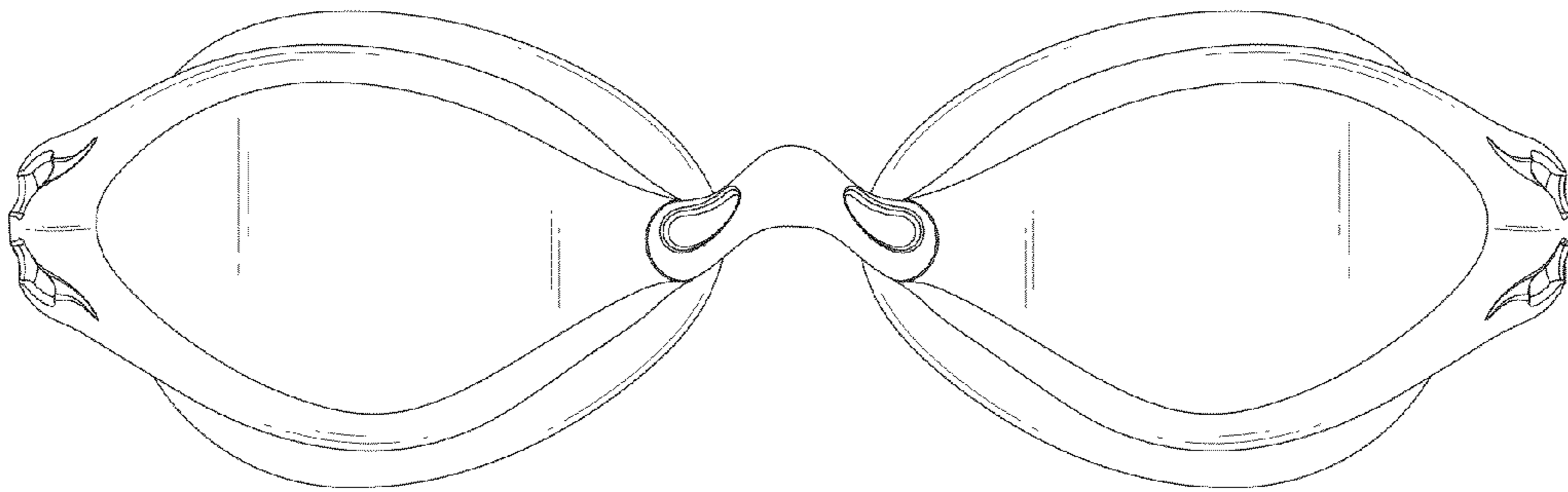

FIG. 2

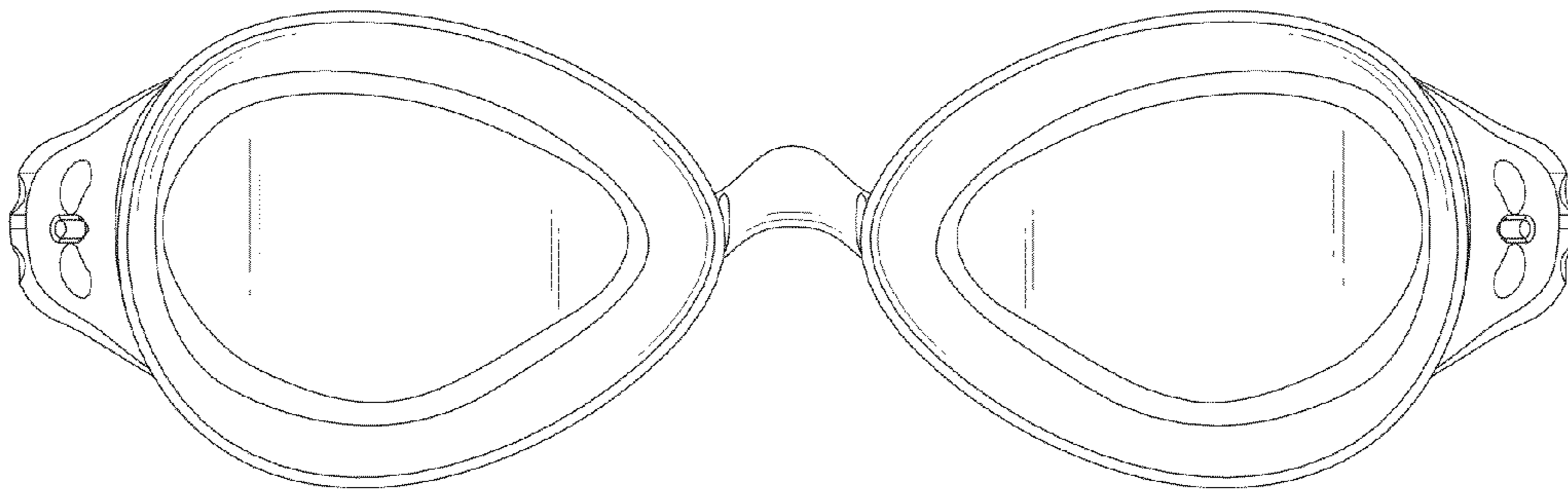

FIG. 3

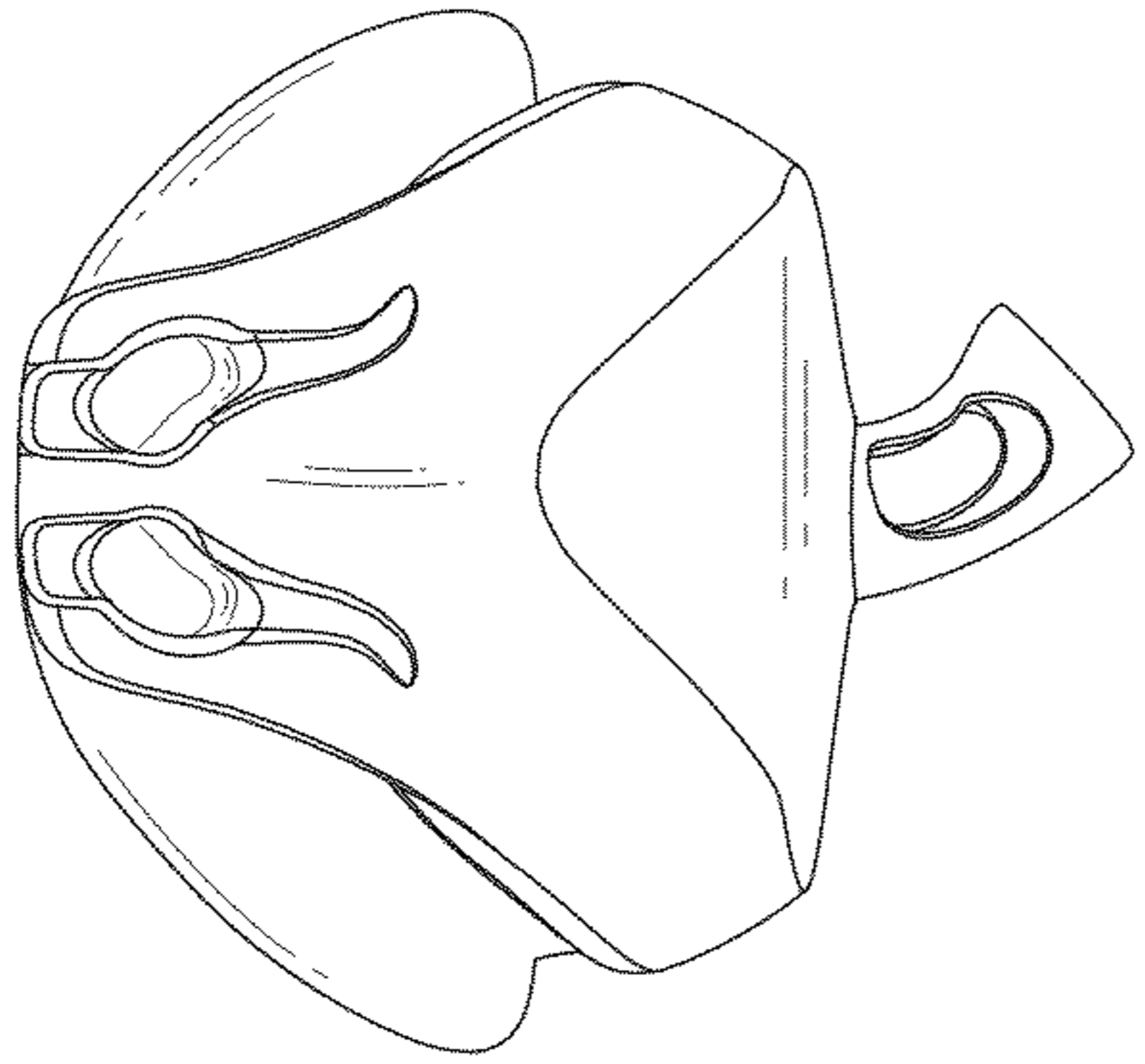

FIG. 4

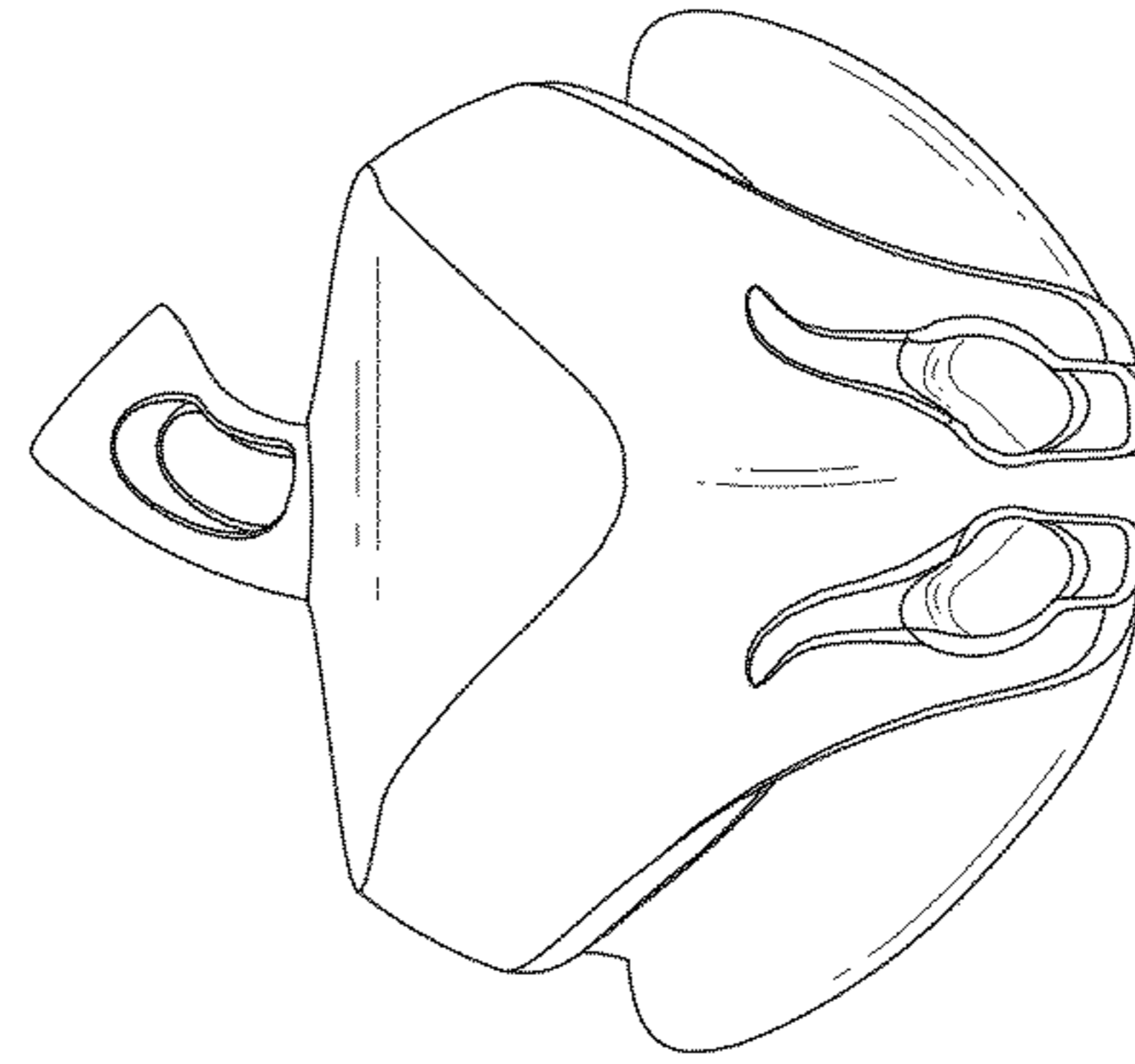

FIG. 5

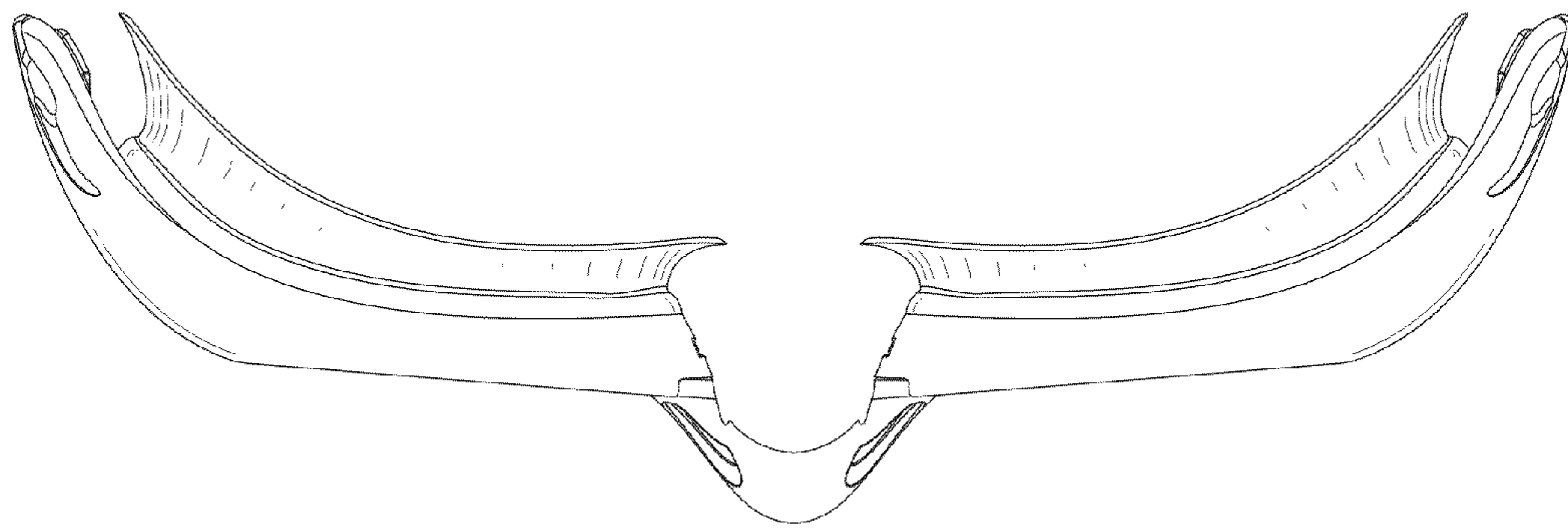

FIG. 6

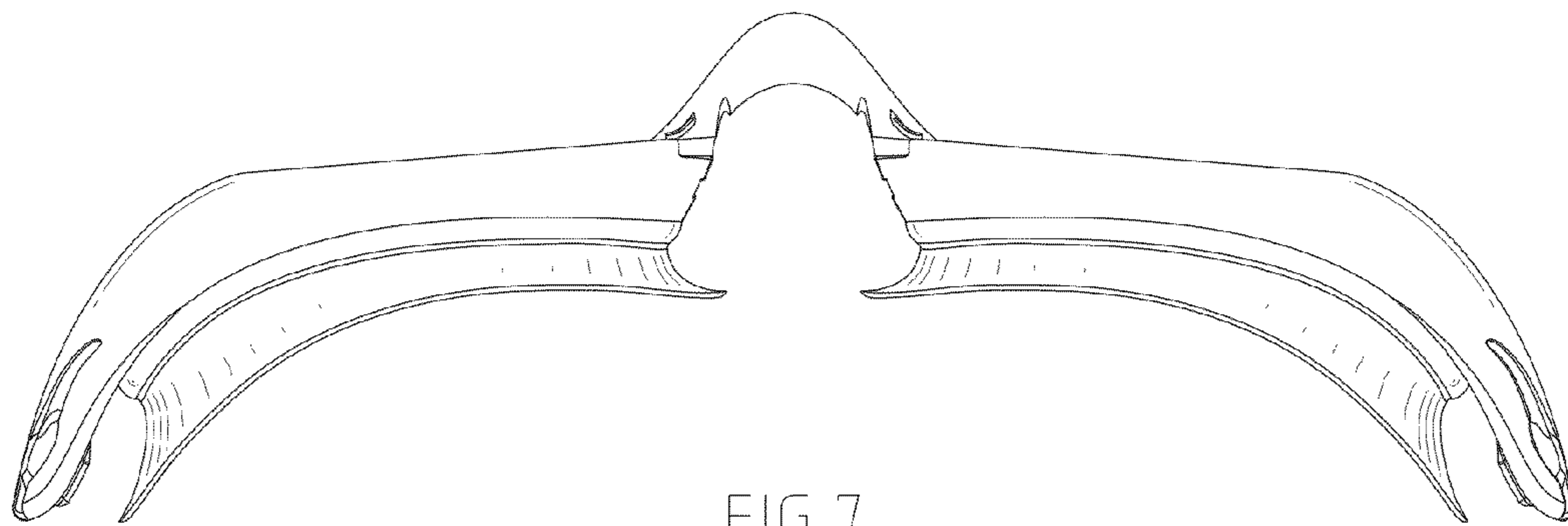

FIG. 7