



US00D717831S

(12) **United States Design Patent**
Sumimoto et al.

(10) **Patent No.:** **US D717,831 S**

(45) **Date of Patent:** **** Nov. 18, 2014**

(54) **SOUND AND IMAGE RECORDER EQUIPPED WITH DISPLAY**

(56) **References Cited**

U.S. PATENT DOCUMENTS

(71) Applicant: **King Jim Co., Ltd.**, Tokyo (JP)
(72) Inventors: **Naohiko Sumimoto**, Tokyo (JP);
Naotoshi Toda, Tokyo (JP); **Shinji Higashiyama**, Chiba (JP)

4,843,624	A *	6/1989	Rashak	381/91
D488,166	S *	4/2004	Daniels	D14/496
6,968,067	B2 *	11/2005	Lopez	381/334
7,303,282	B2 *	12/2007	Dwyer et al.	353/15
D560,685	S *	1/2008	Lopez	D14/496
7,320,520	B2 *	1/2008	Johnson	353/15
D610,589	S *	2/2010	Chia et al.	D14/496
8,212,779	B2 *	7/2012	Chiang	345/169
D686,186	S *	7/2013	Kaneko et al.	D14/168
D691,460	S *	10/2013	Stanic et al.	D8/354

(73) Assignee: **King Jim Co., Ltd.**, Tokyo (JP)

(**) Term: **14 Years**

* cited by examiner

(21) Appl. No.: **29/467,658**

Primary Examiner — Prabhakar Deshmukh

(22) Filed: **Sep. 20, 2013**

(74) *Attorney, Agent, or Firm* — Holtz, Holtz, Goodman & Chick PC

(30) **Foreign Application Priority Data**

(57) **CLAIM**

The ornamental design for a sound and image recorder equipped with display, as shown and described.

Mar. 21, 2013 (JP) 2013-006197

DESCRIPTION

(51) **LOC (10) Cl.** **14-03**

FIG. 1 is a front elevational view of a sound and image recorder equipped with display showing our new design; FIG. 2 is a rear elevational view thereof; FIG. 3 is a left side elevational view thereof; FIG. 4 is right side elevational view thereof; FIG. 5 is a top plan view thereof; FIG. 6 is a bottom plan view thereof; FIG. 7 is a top, front, right side perspective view thereof; FIG. 8 is a top, rear, left side perspective view thereof; FIG. 9 is a front elevational view thereof with the power on; and, FIG. 10 is a top, front, right side perspective view thereof with the power on.

(52) **U.S. Cl.**

USPC **D14/496**; D14/203.7; D14/203.1

(58) **Field of Classification Search**

USPC D14/496, 401, 435, 474, 483, 217, 137, D14/138, 160, 168, 356, 203.1–203.8, 507; 345/156, 169, 173–179, 905; 715/727–729, 864; 710/1, 5, 8; 713/1, 713/600; 455/1.1, 1.7, 73, 344–347, 93, 95, 455/3.01–3.06, 550.1, 573.1; 370/342–344; 369/1, 2, 6–12; 463/43–47; 273/148 B

See application file for complete search history.

1 Claim, 5 Drawing Sheets

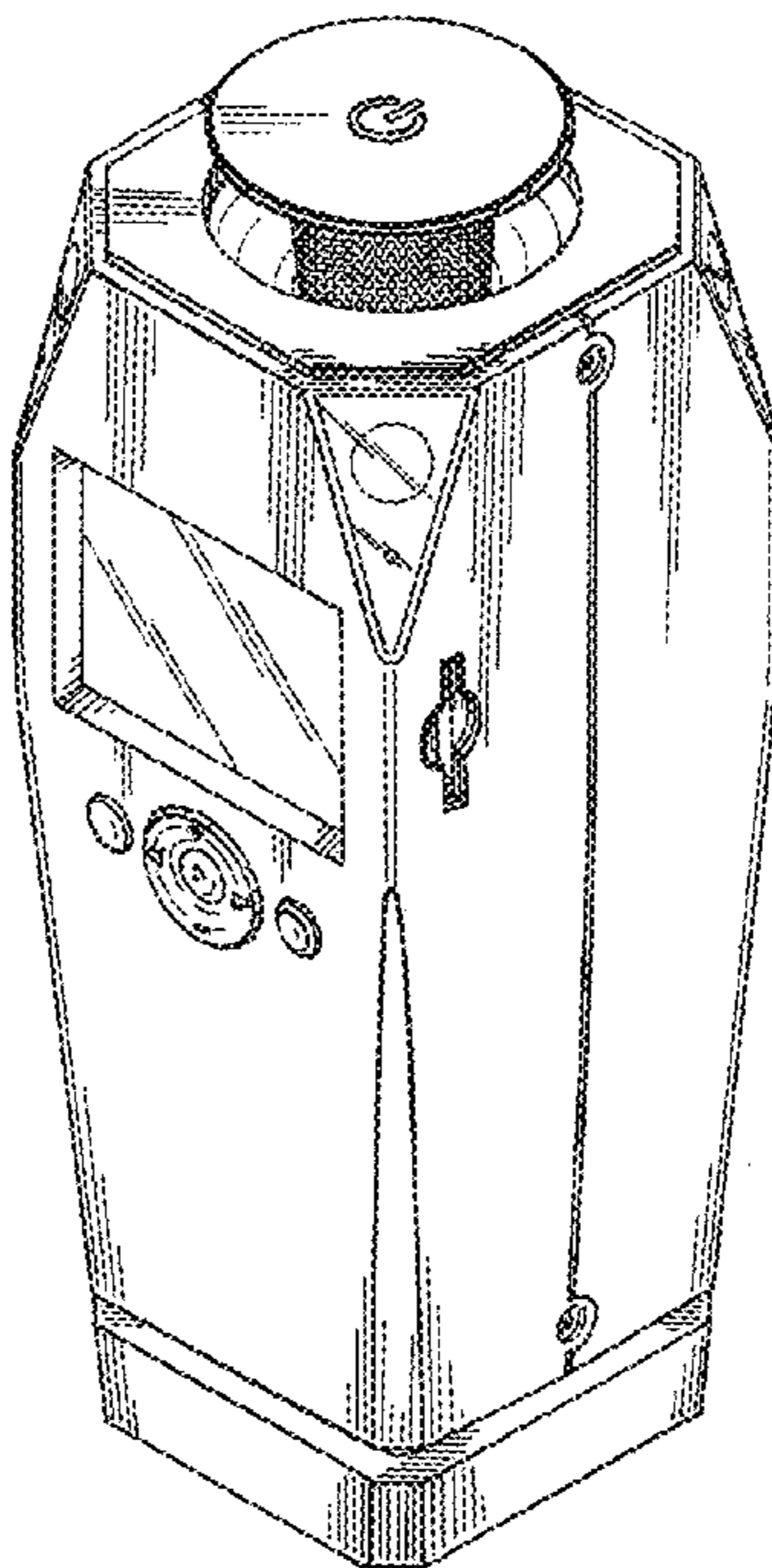

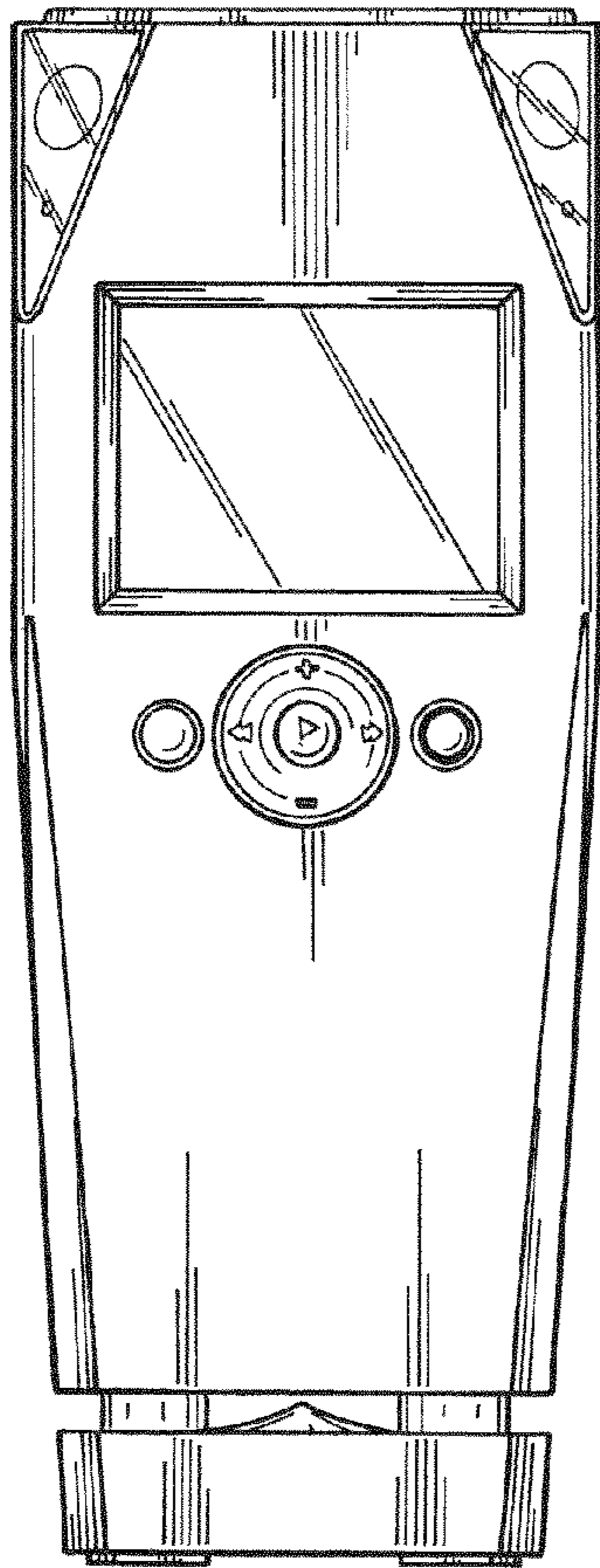

Fig. 1

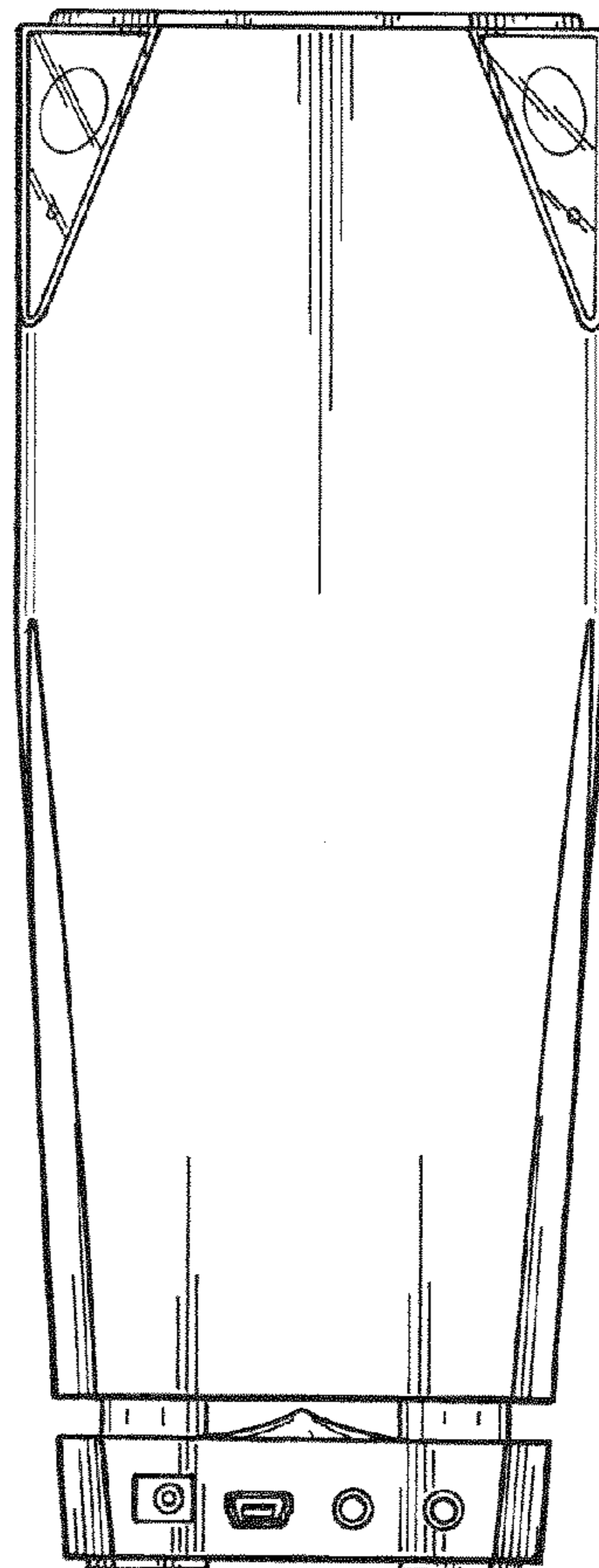

Fig. 2

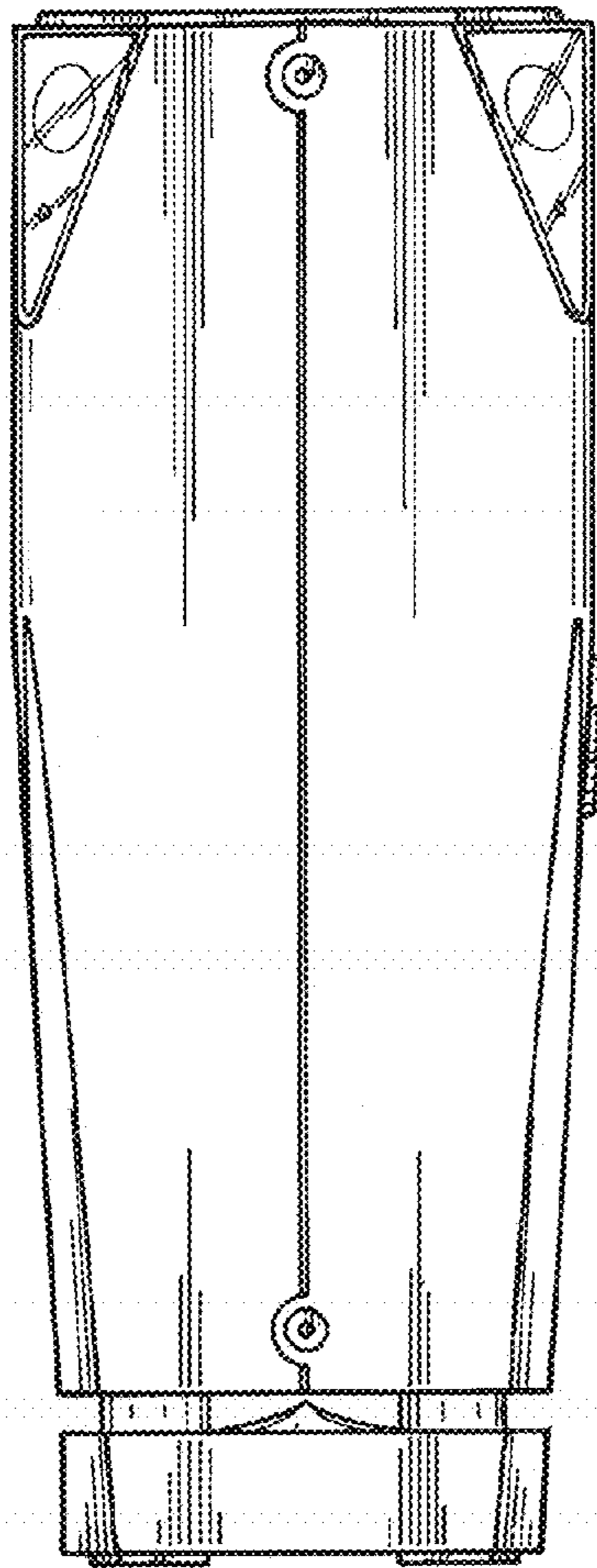

Fig. 3

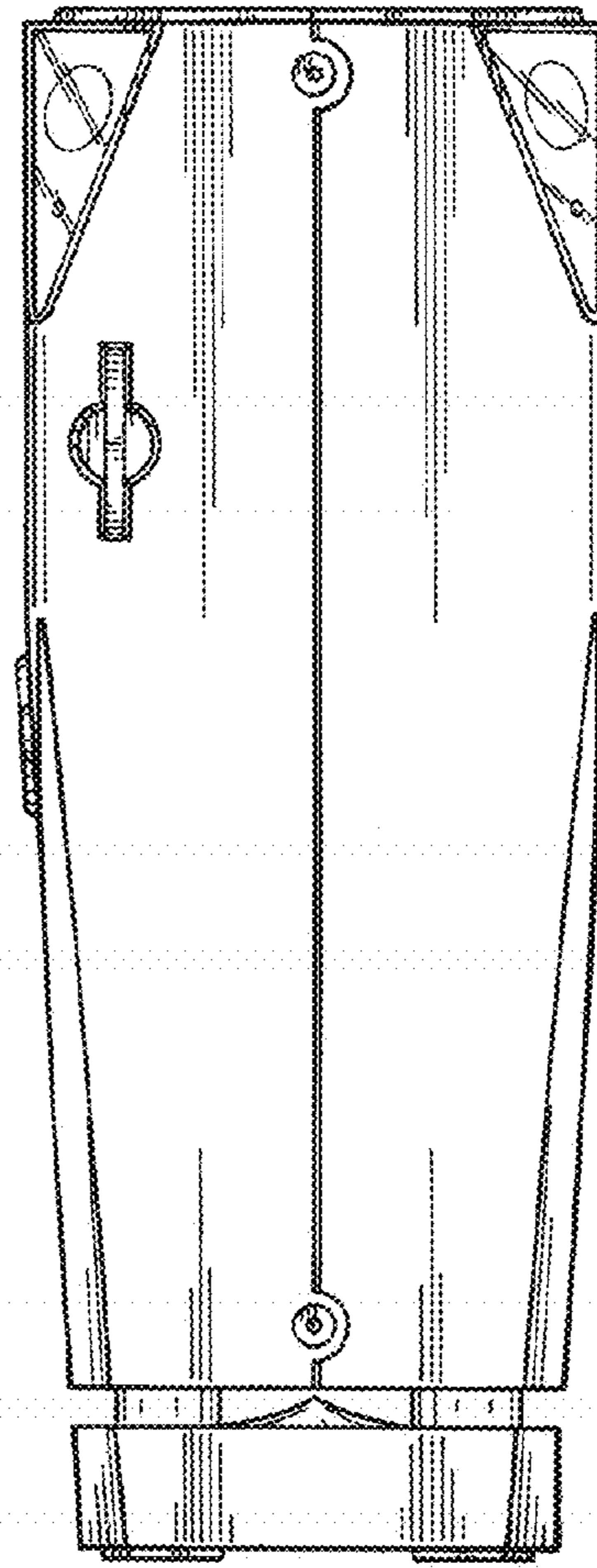

Fig. 4

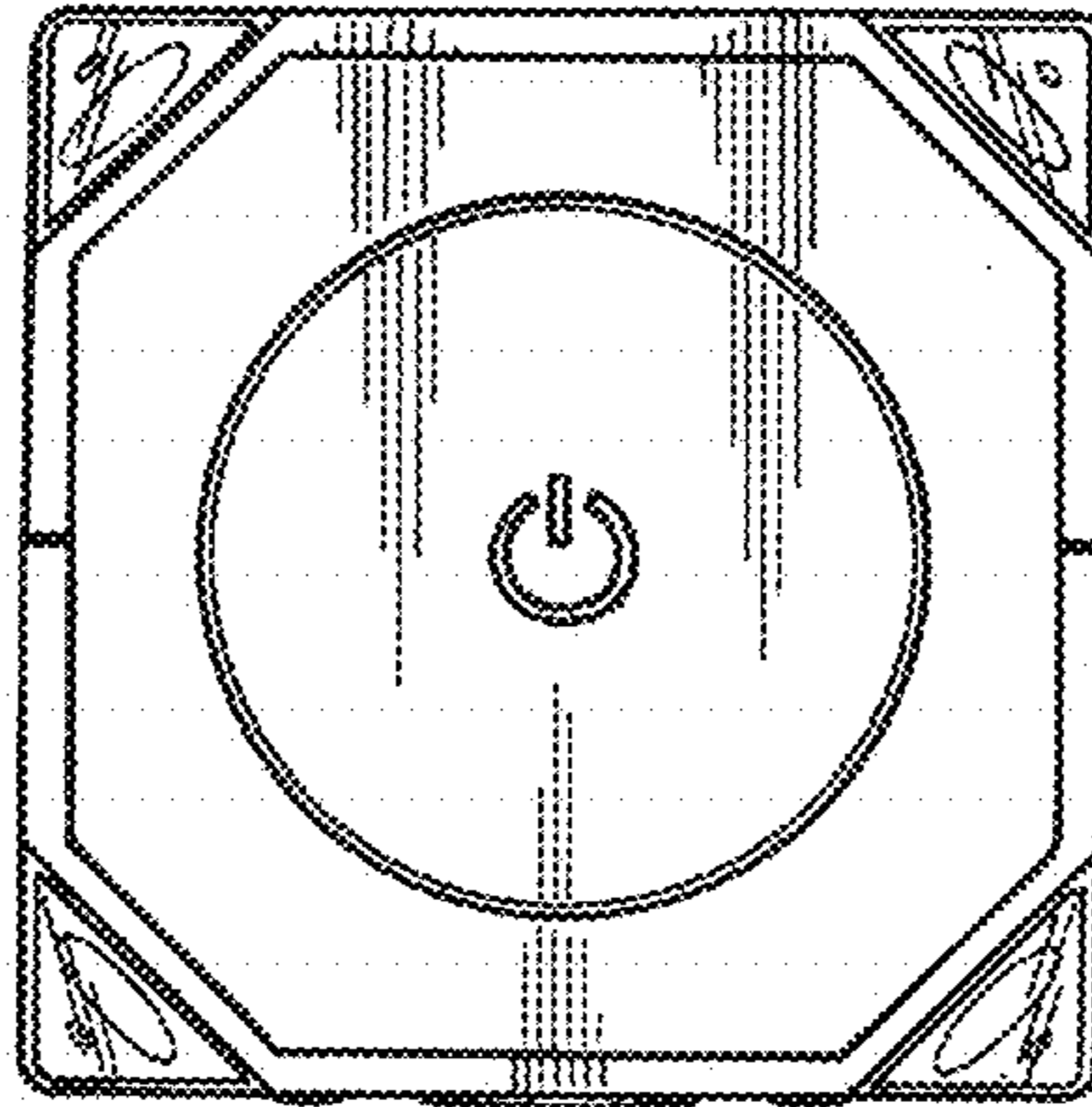

Fig. 5

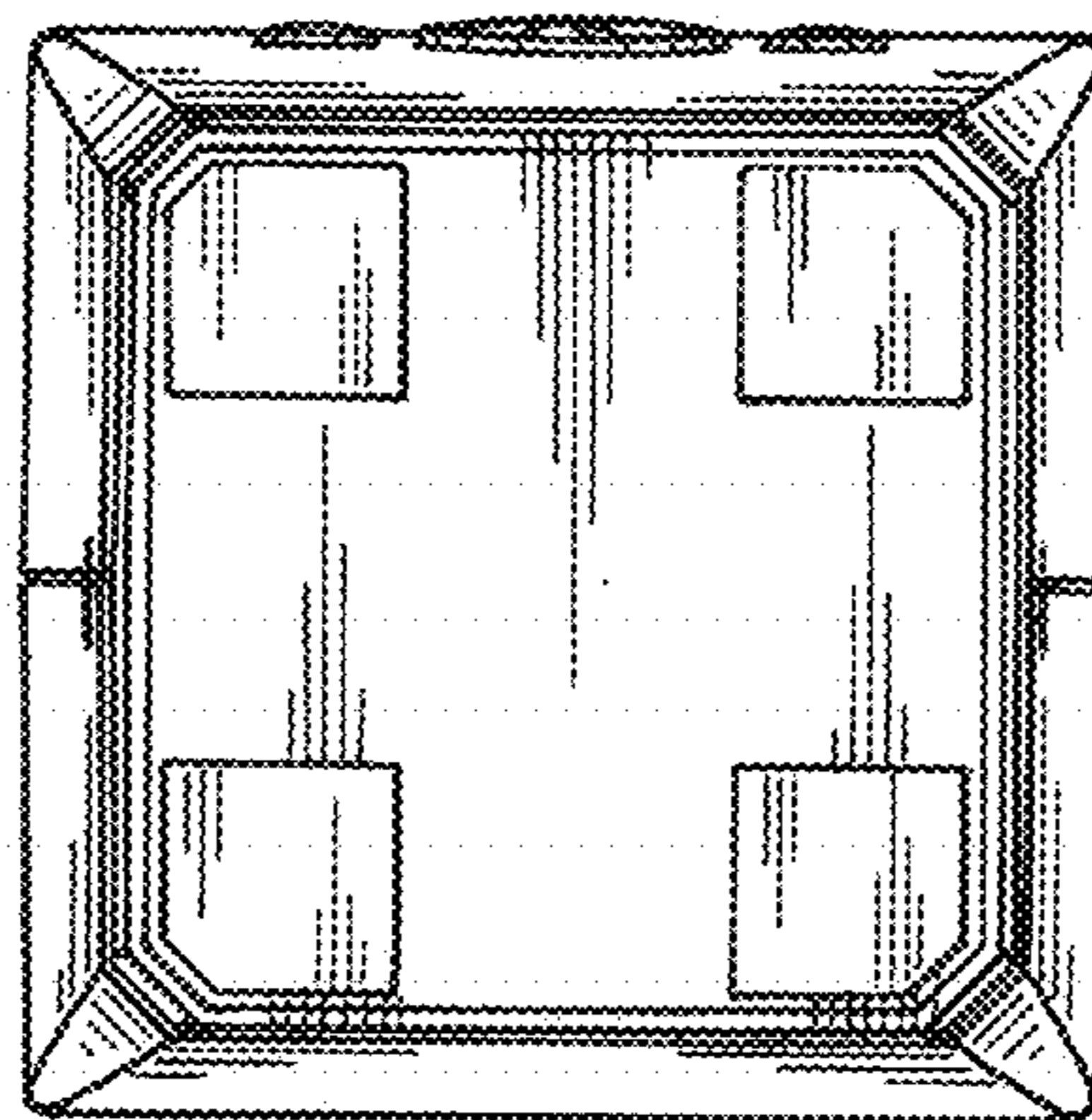

Fig. 6

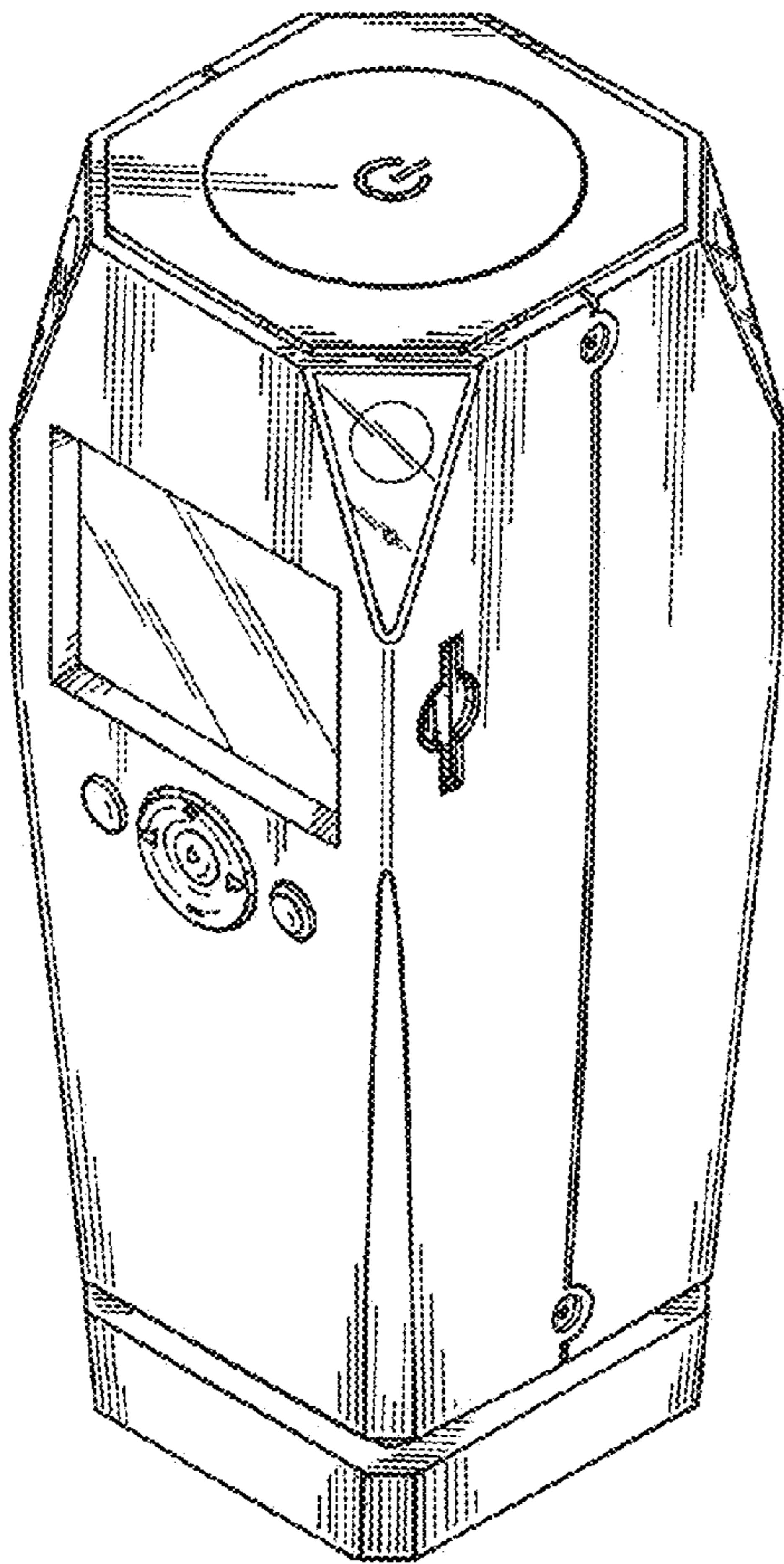

Fig. 7

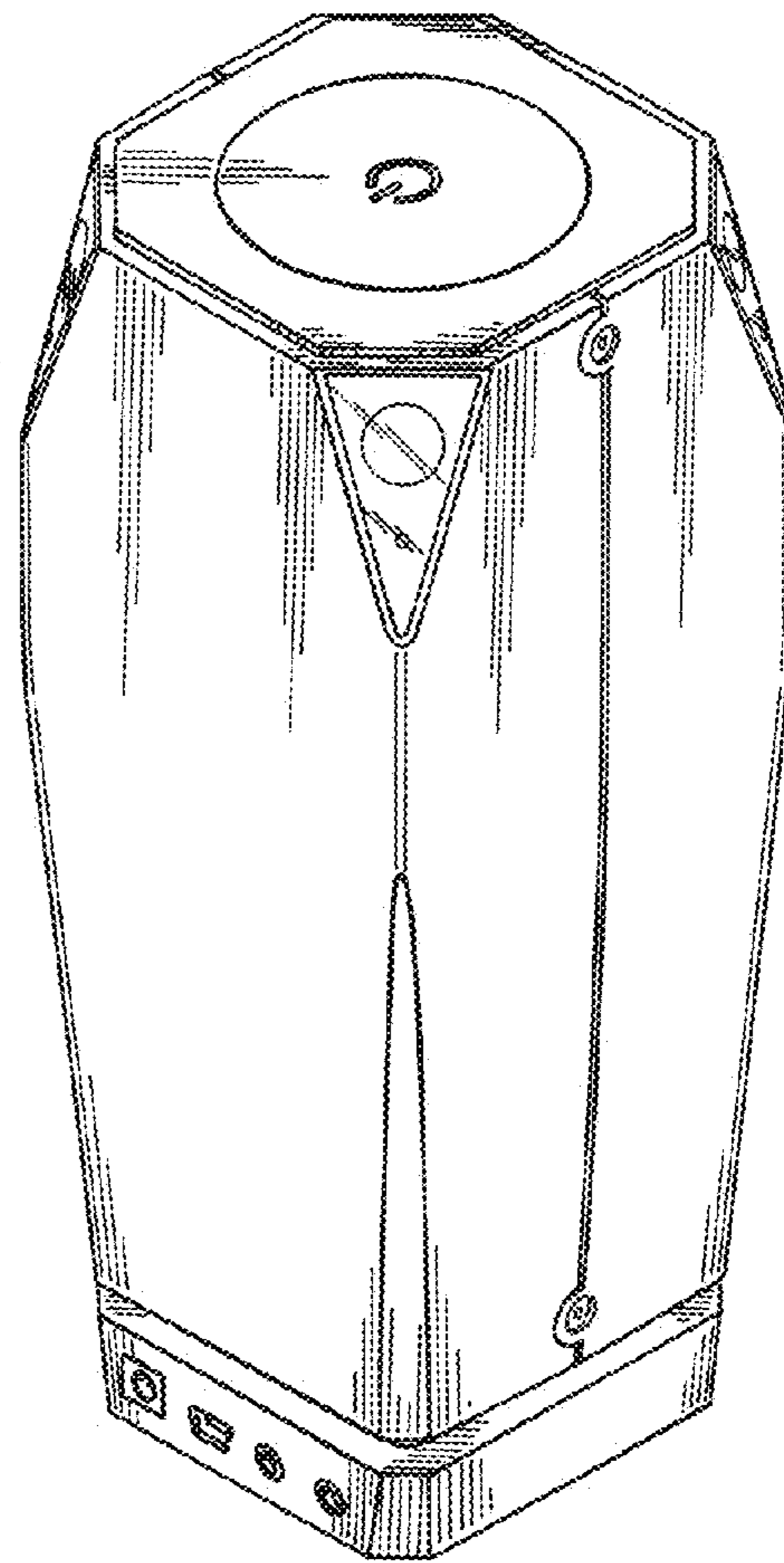

Fig. 8

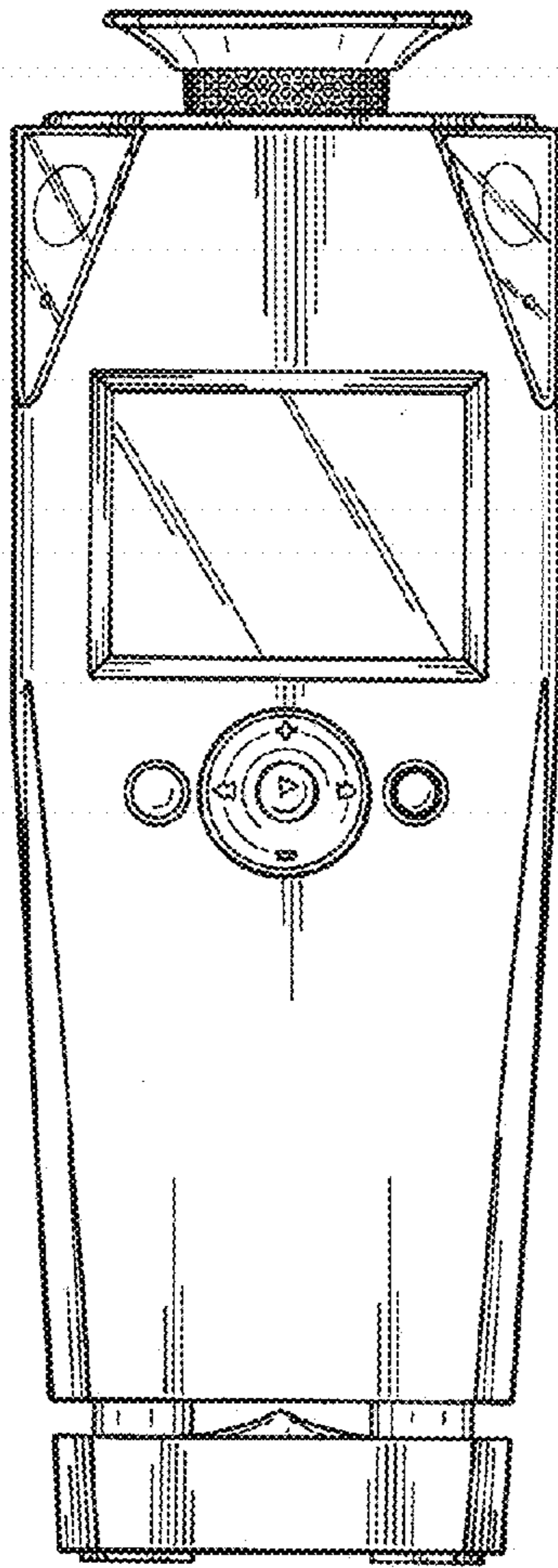

Fig. 9

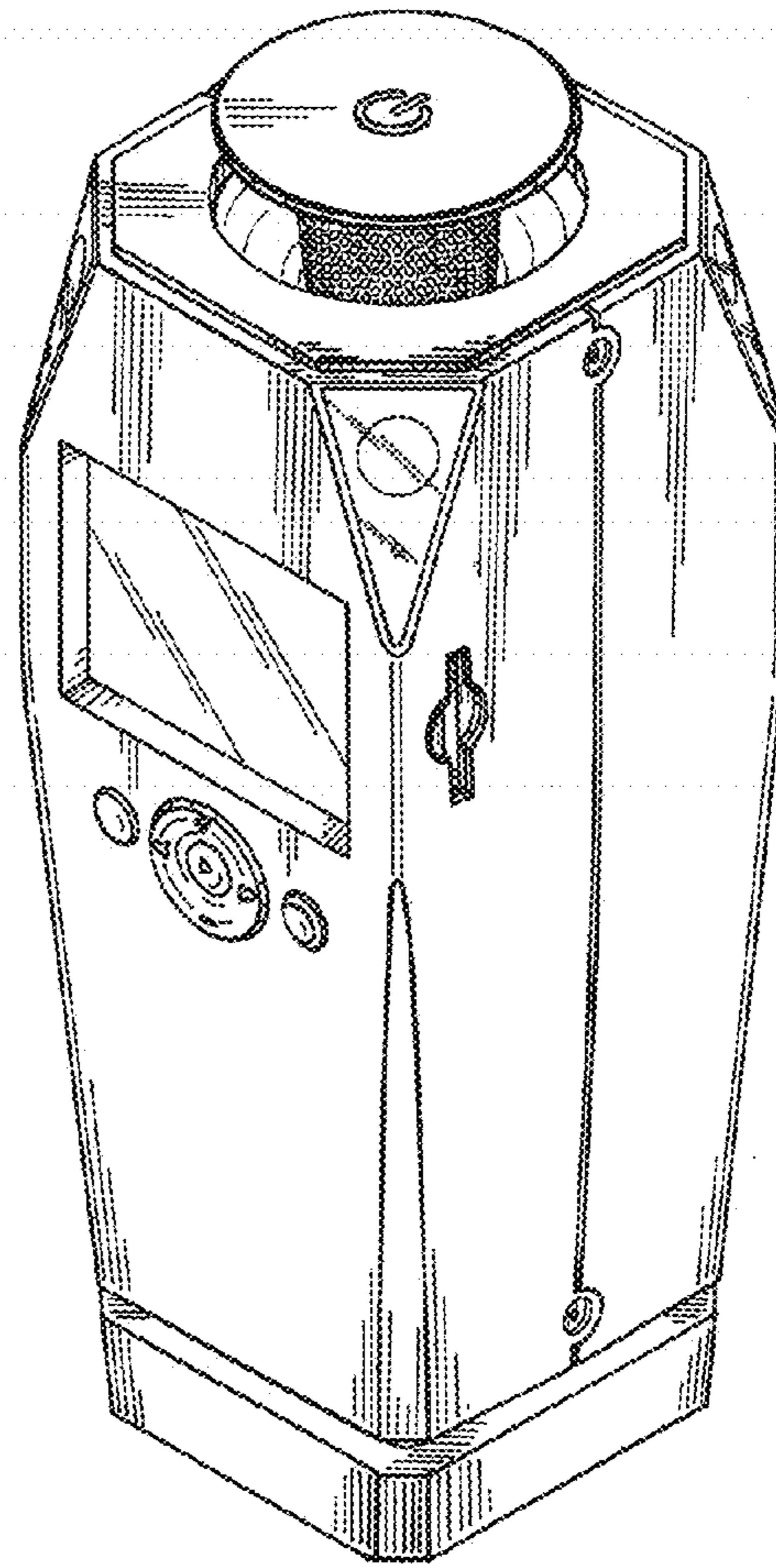

Fig. 10