



US00D717798S

(12) **United States Design Patent**  
**Groene et al.**

(10) **Patent No.:** **US D717,798 S**

(45) **Date of Patent:** **\*\* Nov. 18, 2014**

(54) **STYLUS**

(71) Applicant: **Microsoft Corporation**, Redmond, WA  
(US)

(72) Inventors: **Ralf Groene**, Kirkland, WA (US);  
**Anthony Reed**, Sammamish, WA (US);  
**Kurt Wrisley**, Redmond, WA (US); **Hua**  
**Wang**, Redmond, WA (US)

(73) Assignee: **Microsoft Corporation**, Redmond, WA  
(US)

(\*\*) Term: **14 Years**

(21) Appl. No.: **29/491,227**

(22) Filed: **May 19, 2014**

(51) **LOC (10) Cl.** ..... **14-02**

(52) **U.S. Cl.**  
USPC ..... **D14/411**

(58) **Field of Classification Search**  
USPC ..... D8/61; D14/411; D19/35, 36, 41-51,  
D19/54-58; 401/55, 99, 100, 104-107, 196,  
401/197, 202, 208, 209, 213, 192, 195,  
401/243; 708/107; 345/179, 173;  
178/19.01; 700/94

See application file for complete search history.

(56) **References Cited**

U.S. PATENT DOCUMENTS

D655,292	S	*	3/2012	Nakata	.....	D14/411
D669,896	S	*	10/2012	Nakata	.....	D14/411
D669,897	S	*	10/2012	Nakata	.....	D14/411
D670,289	S	*	11/2012	Bae et al.	.....	D14/411
D670,700	S	*	11/2012	Halsinger et al.	.....	D14/411
D682,833	S	*	5/2013	Paschke et al.	.....	D14/411
D684,578	S	*	6/2013	Son	.....	D14/411
D688,666	S	*	8/2013	Kowari et al.	.....	D14/411
D694,238	S	*	11/2013	Du	.....	D14/411
D694,326	S	*	11/2013	Cambianica	.....	D19/186
D699,723	S	*	2/2014	Nishizawa	.....	D14/411
D705,780	S	*	5/2014	Nishizawa	.....	D14/411

\* cited by examiner

*Primary Examiner* — Austin Murphy

(74) *Attorney, Agent, or Firm* — Banner & Witcoff, Ltd.

(57) **CLAIM**

The ornamental design for a stylus, as shown and described.

**DESCRIPTION**

FIG. 1 is a front isometric view of a stylus showing our new design;  
FIG. 2 is a top view thereof;  
FIG. 3 is a bottom view thereof;  
FIG. 4 is a front view thereof;  
FIG. 5 is a rear view thereof;  
FIG. 6 is a left side view thereof; and,  
FIG. 7 is a right side view thereof.  
The broken line showing of the clip feature is for environmental purposes only and forms no part of the claimed design.

**1 Claim, 4 Drawing Sheets**

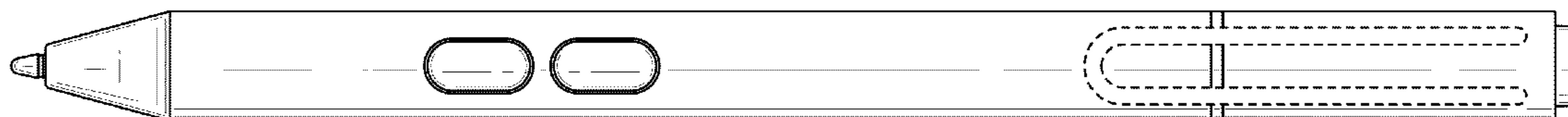

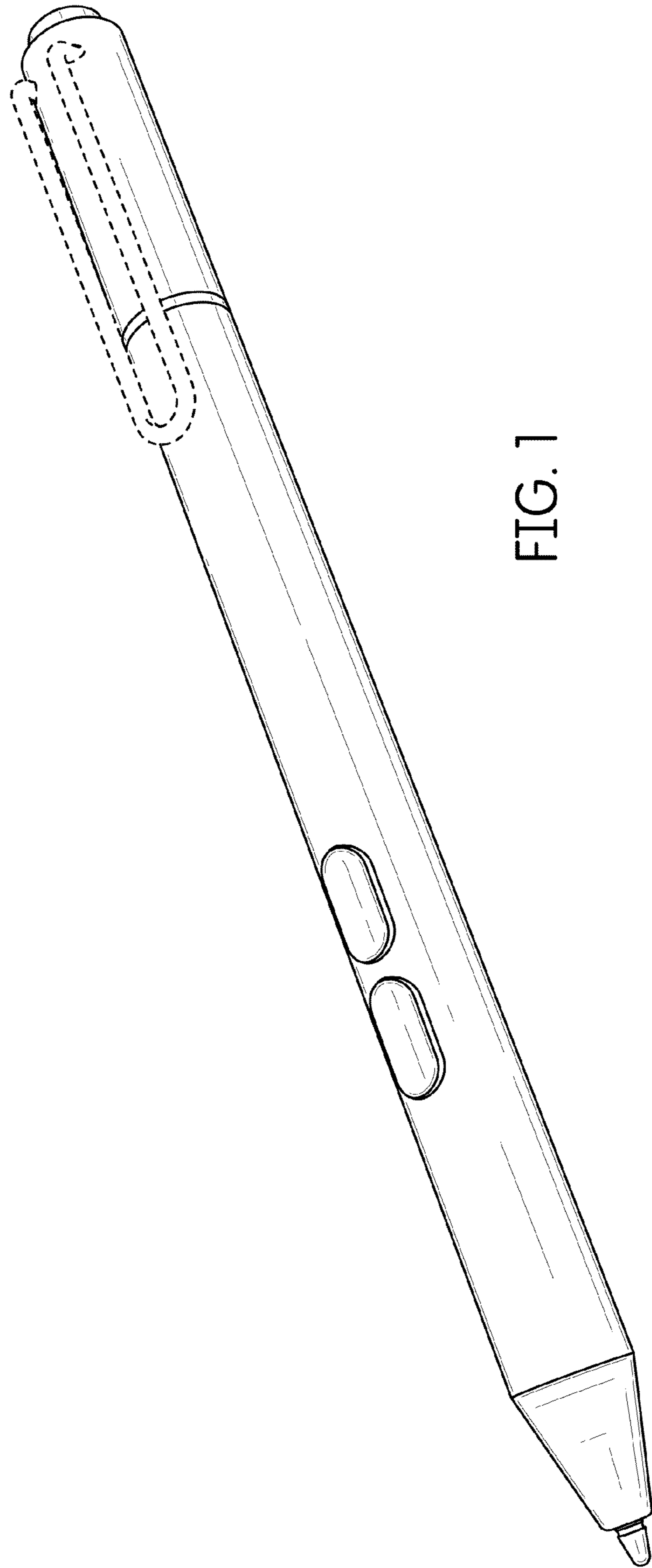

FIG. 1

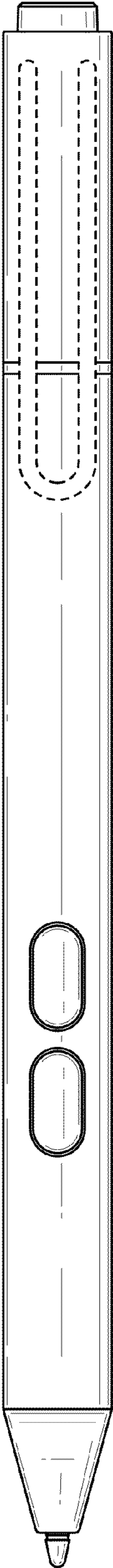

FIG. 2

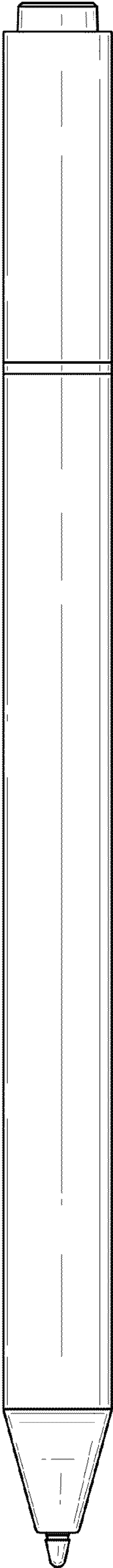

FIG. 3

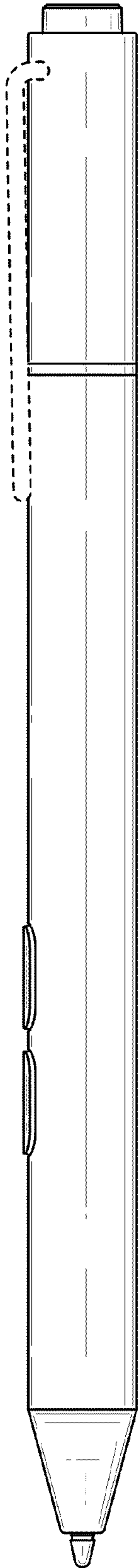

FIG. 4

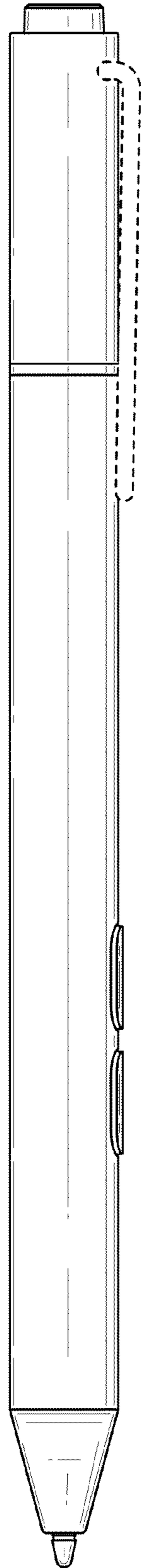

FIG. 5

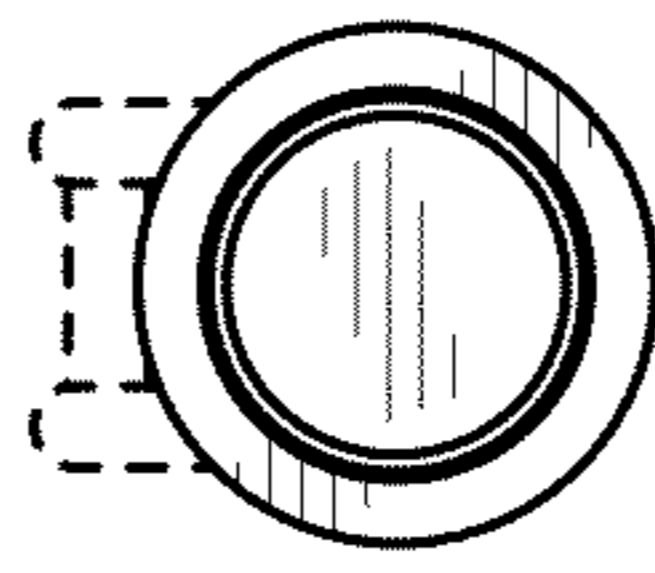

FIG. 7

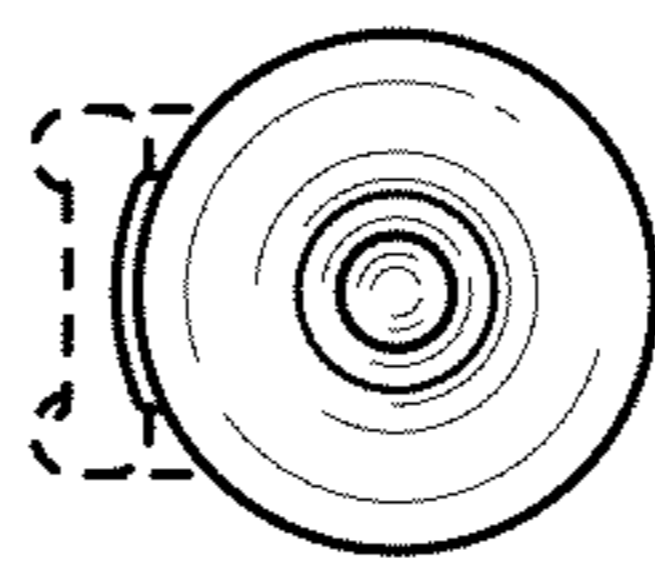

FIG. 6