



US00D717785S

(12) **United States Design Patent**
Winston et al.

(10) **Patent No.:** **US D717,785 S**
(45) **Date of Patent:** **** Nov. 18, 2014**

(54) **KIOSK FOR MEDIA DOWNLOADS**

(71) Applicant: **Spigot Media Corp.**, Toronto (CA)

(72) Inventors: **Jason Winston**, Toronto (CA); **Steve McArdle**, Milton (CA)

(73) Assignee: **Spigot Media Corp.**, Toronto (CA)

(**) Term: **14 Years**

(21) Appl. No.: **29/493,538**

(22) Filed: **Jun. 10, 2014**

(51) **LOC (10) Cl.** **14-02**

(52) **U.S. Cl.**
USPC **D14/307**

(58) **Field of Classification Search**
CPC G06Q 20/18; G06Q 20/10; G06Q 20/123;
G06Q 20/20; G06Q 30/02; G06Q 30/06;
A47F 9/047
USPC D14/315-327, 384, 432, 439-446, 341,
D14/345, 353-355, 125, 130, 132, 138,
D14/239; D16/202, 208; D9/424-432;
D6/491; D8/403; 235/145 A, 145 R;
341/22, 23; 349/12; 361/680-686;
D20/10, 41, 43

See application file for complete search history.

(56) **References Cited**

U.S. PATENT DOCUMENTS

D518,480 S * 4/2006 Zheng et al. D14/307
D569,898 S * 5/2008 Masuda D18/4.5

D587,699 S * 3/2009 Corti et al. D14/307
D587,700 S * 3/2009 Corti et al. D14/307
D589,829 S * 4/2009 Friedli D10/108
D601,052 S * 9/2009 Friedli D10/108
D605,191 S * 12/2009 Kuroda et al. D14/307
D621,513 S * 8/2010 Cinqualbre D24/185
D637,595 S * 5/2011 Mizusugi D14/307
D661,293 S * 6/2012 Kuroda et al. D14/307
D671,535 S * 11/2012 Terashima et al. D14/307
D692,885 S * 11/2013 Cruz D14/385
D696,658 S * 12/2013 Winston et al. D14/307

* cited by examiner

Primary Examiner — Austin Murphy

(74) *Attorney, Agent, or Firm* — Spencer C. Patterson

(57) **CLAIM**

The ornamental design for a kiosk for media downloads, substantially as shown and described.

DESCRIPTION

FIG. 1 is a front perspective view of a kiosk.
FIG. 2 is a front view of the kiosk.
FIG. 3 is a back view of the kiosk.
FIG. 4 is a right side view of the kiosk.
FIG. 5 is a left side view of the kiosk.
FIG. 6 is a top view of the kiosk.
FIG. 7 is a bottom view of the kiosk; and,
FIG. 8 is a back perspective view of a kiosk.
The broken lines which define the bounds of the claimed design form no part thereof.

1 Claim, 6 Drawing Sheets

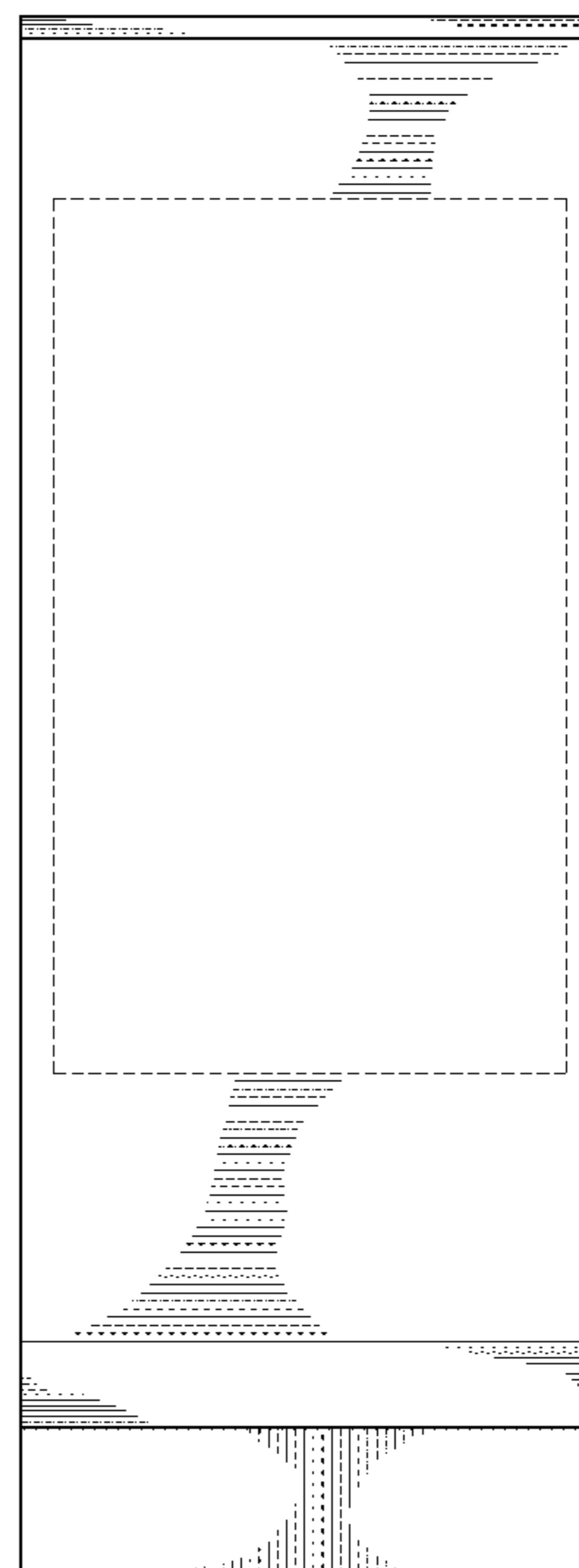
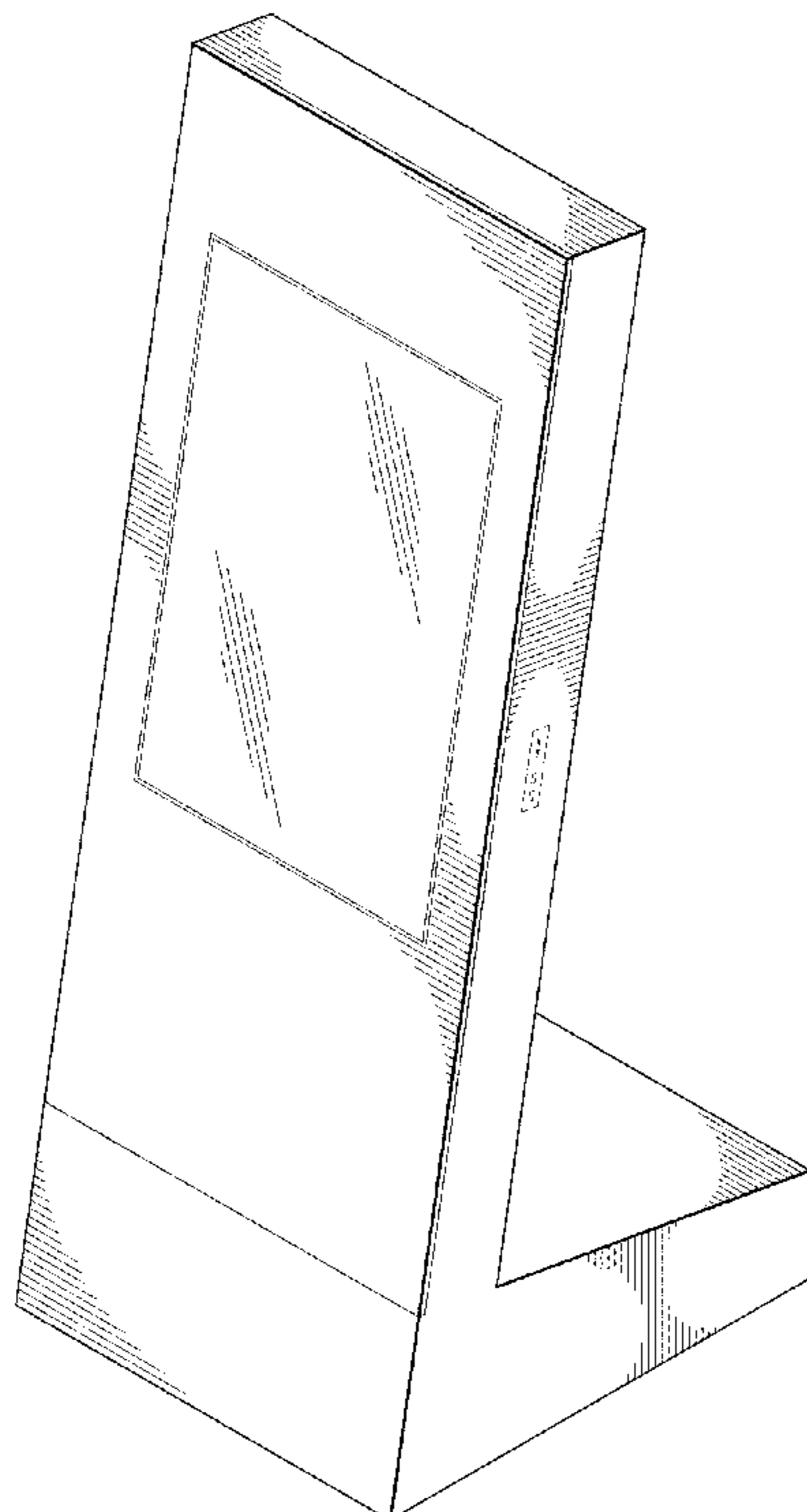

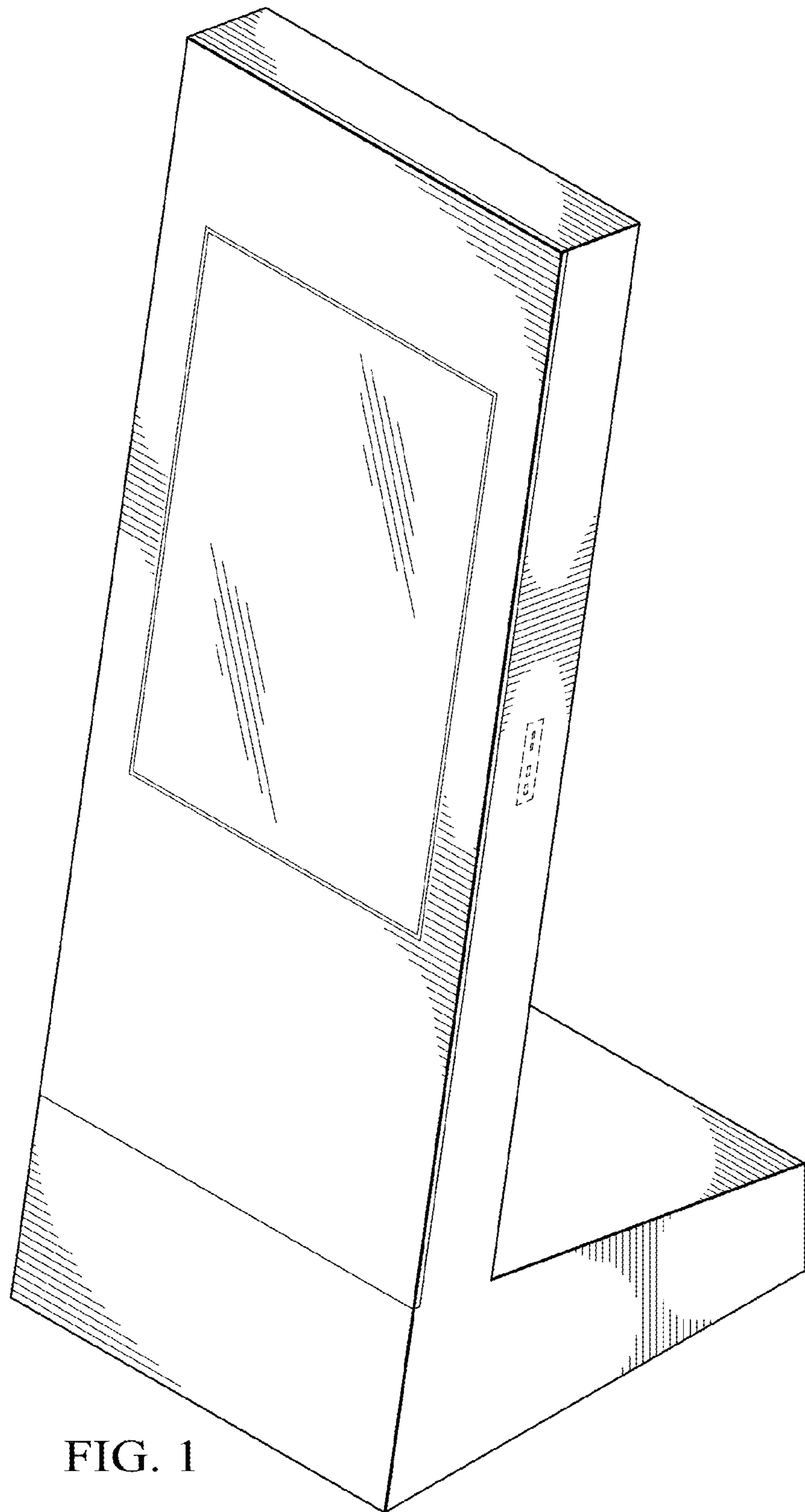

FIG. 1

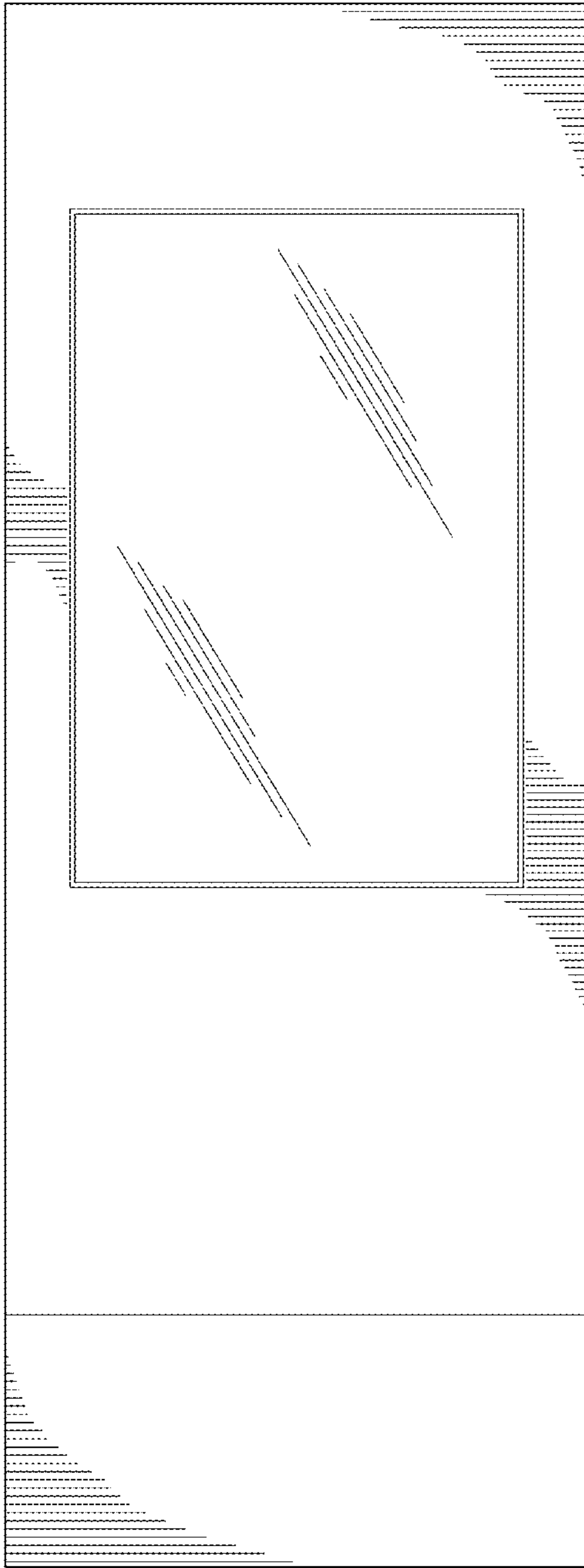

FIG. 2

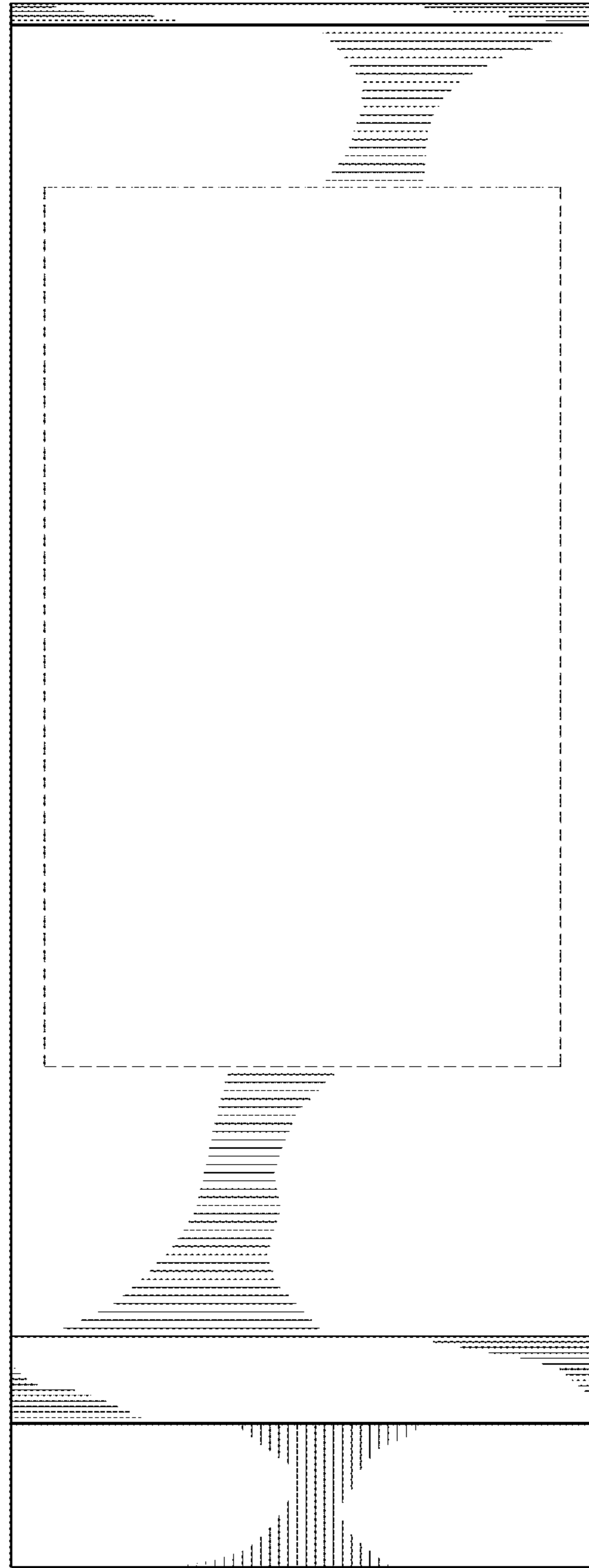

FIG. 3

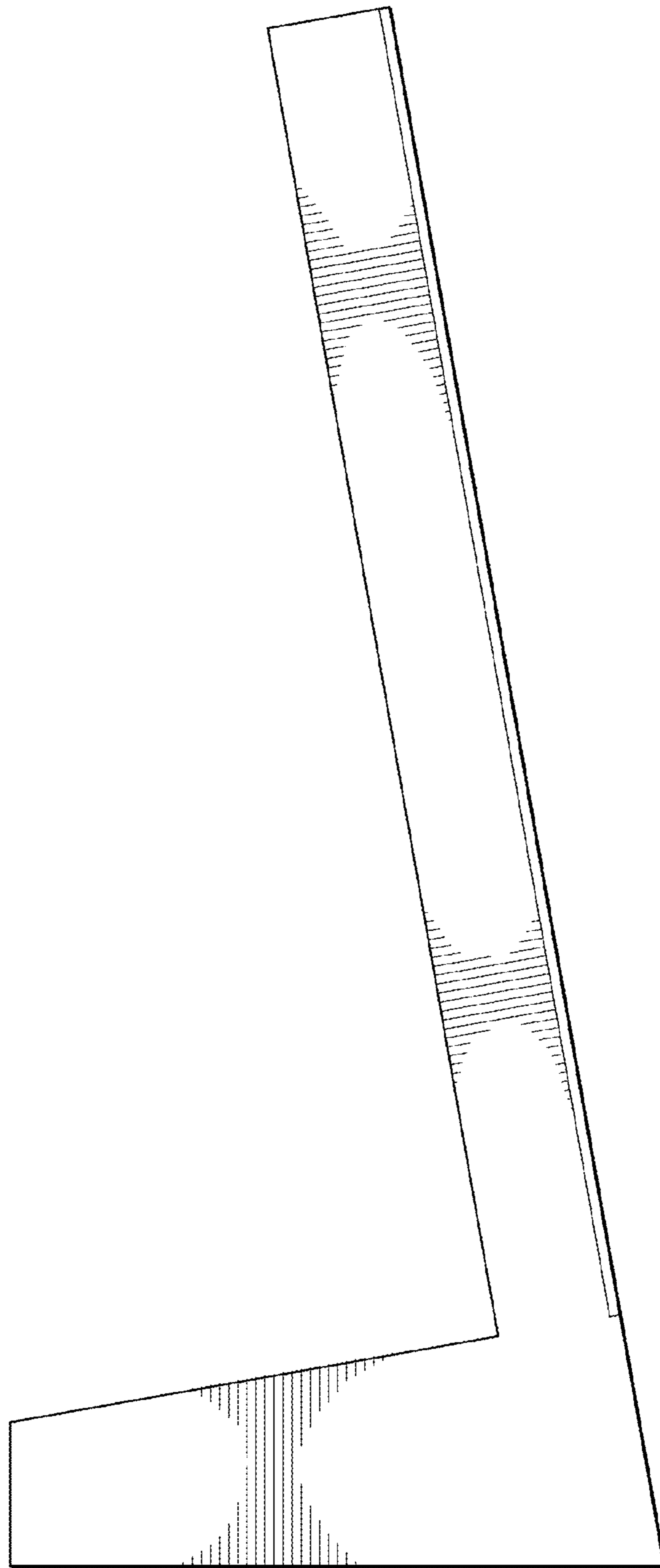

FIG. 4

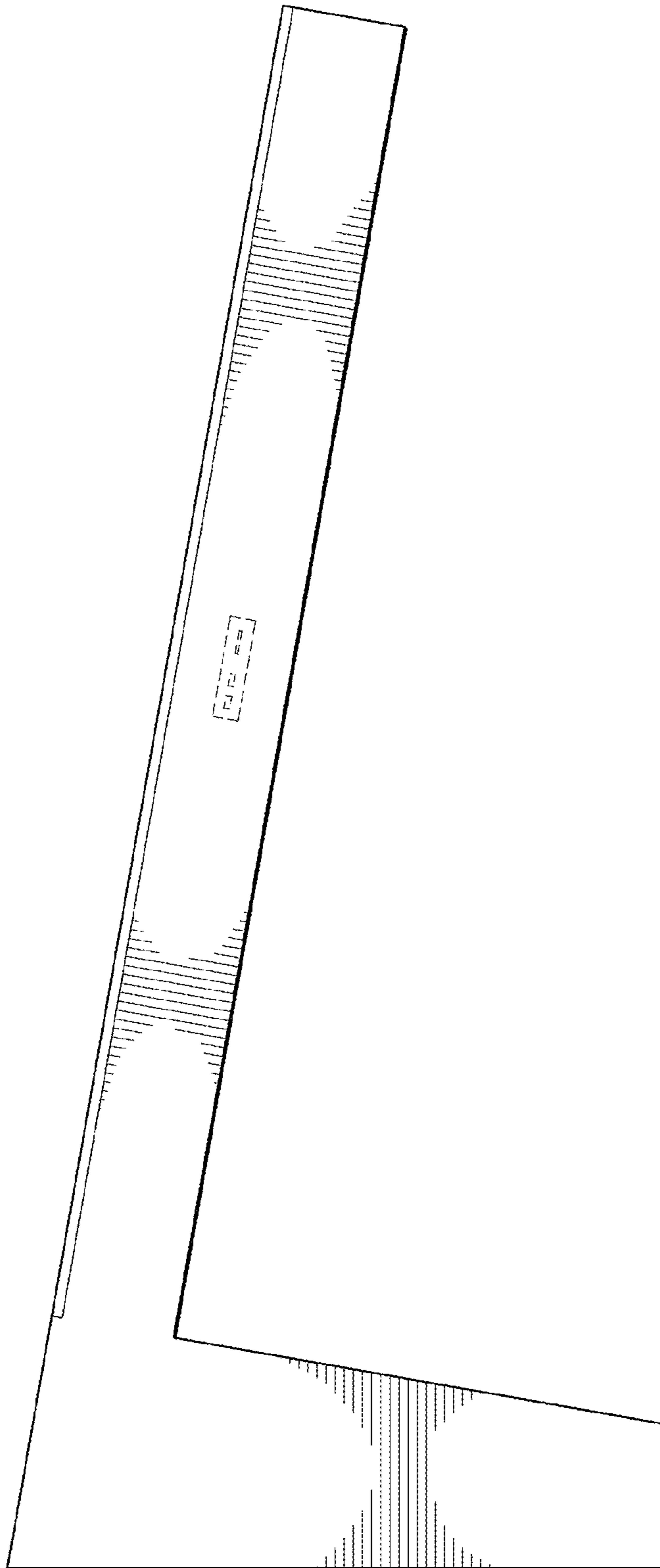

FIG. 5

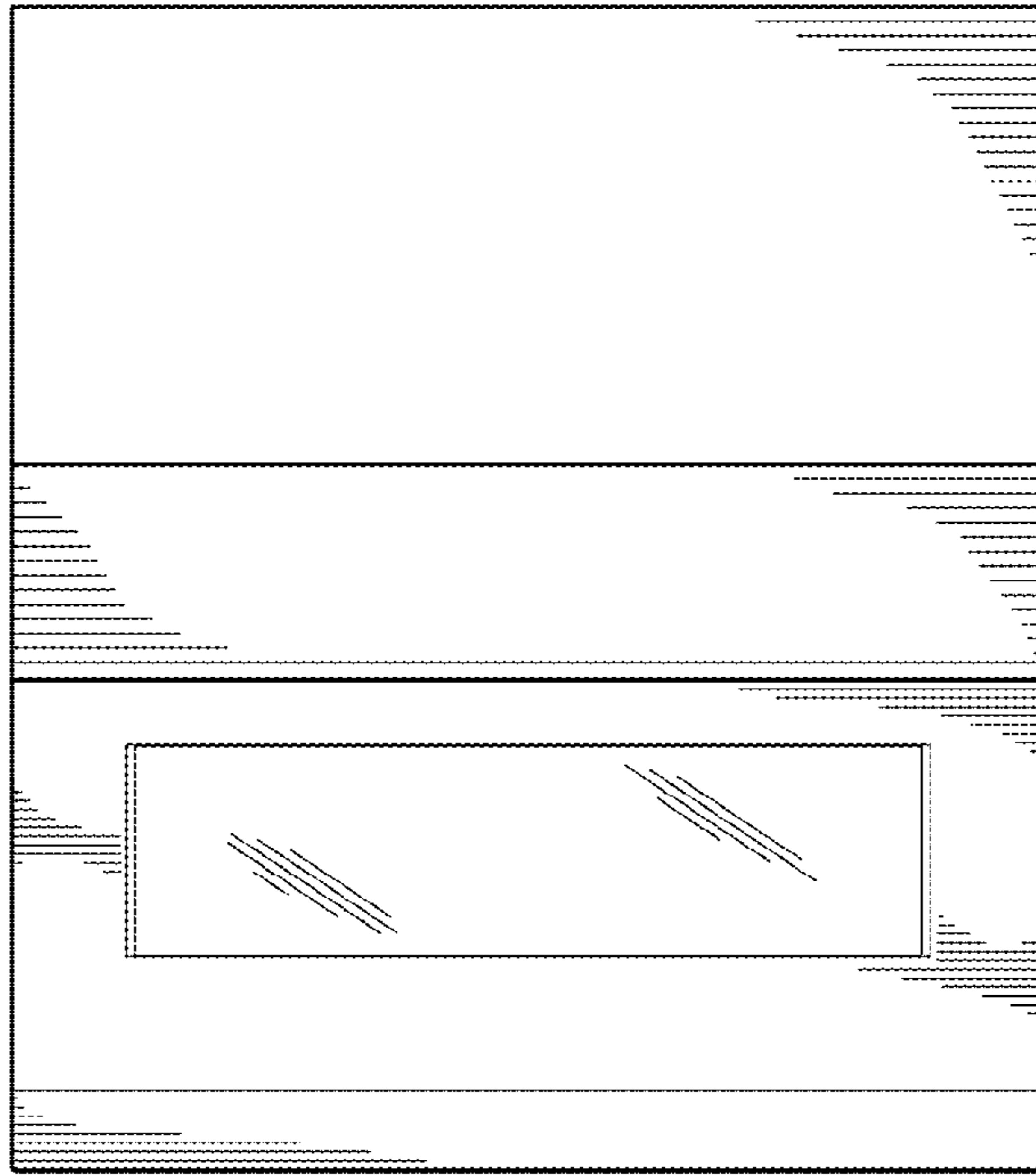

FIG. 6

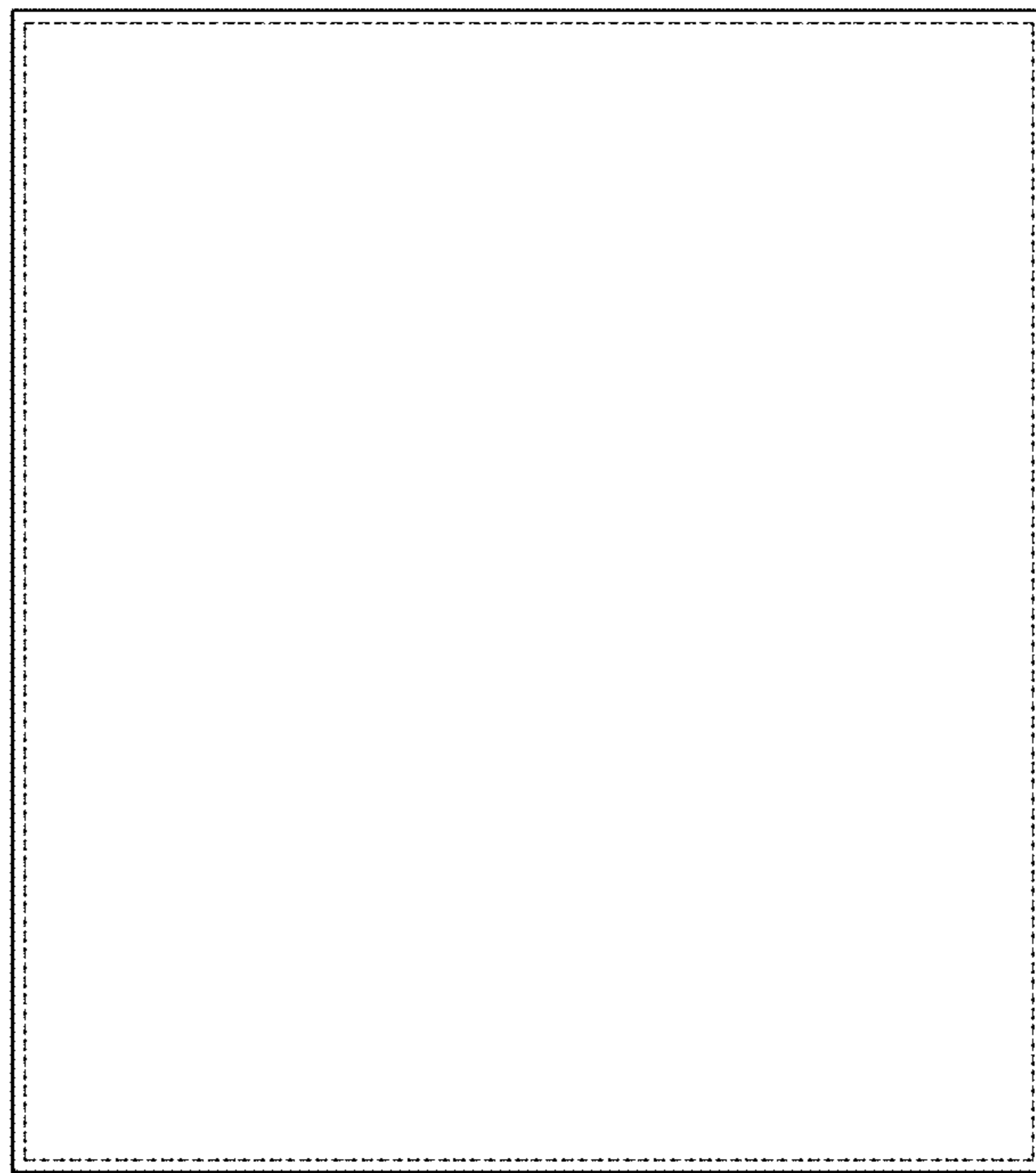

FIG. 7

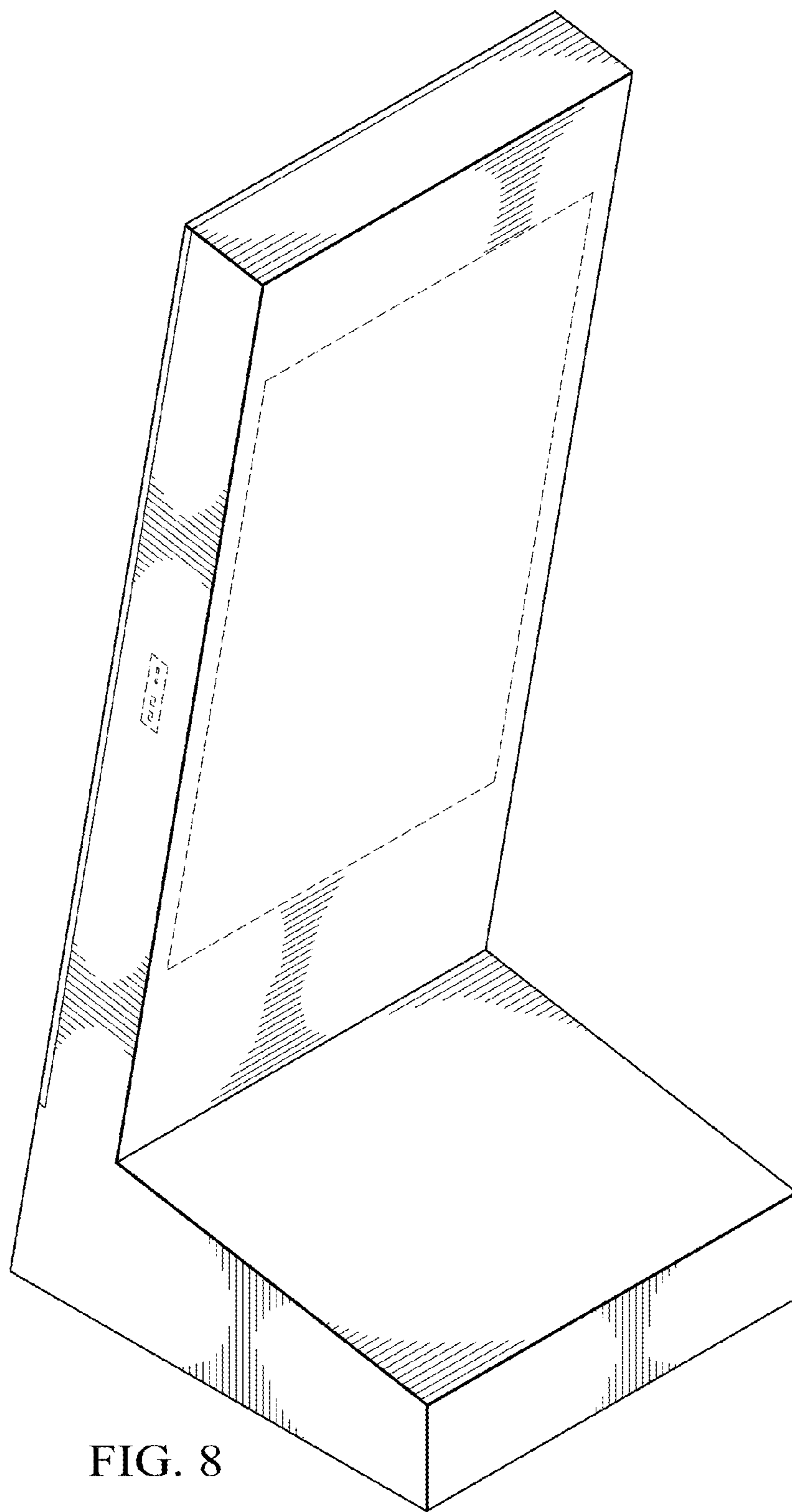

FIG. 8