



US00D717732S

(12) **United States Design Patent**  
**Byrne et al.**

(10) **Patent No.:** **US D717,732 S**  
(45) **Date of Patent:** **\*\* Nov. 18, 2014**

(54) **ELECTRICAL POWER UNIT FOR A WORK SURFACE**

D288,298 S 2/1987 Yang  
5,566,053 A \* 10/1996 Chou ..... 361/753  
D389,459 S 1/1998 Byrne  
5,738,548 A 4/1998 Rutulante  
D405,416 S 2/1999 Byrne

(71) Applicants: **Daniel P. Byrne**, Lowell, MI (US);  
**Chad Zimmerman**, Hastings, MI (US);  
**William F. Schacht**, Grand Rapids, MI (US);  
**Randell E. Pate**, Jenison, MI (US);  
**Brent A. Reame**, Grand Rapids, MI (US);  
**Timothy J. Warwick**, Sparta, MI (US)

(Continued)

*Primary Examiner* — Ian Simmons  
*Assistant Examiner* — Rhea Shields  
(74) *Attorney, Agent, or Firm* — Gardner, Linn, Burkhardt & Flory, LLP

(72) Inventors: **Daniel P. Byrne**, Lowell, MI (US);  
**Chad Zimmerman**, Hastings, MI (US);  
**William F. Schacht**, Grand Rapids, MI (US);  
**Randell E. Pate**, Jenison, MI (US);  
**Brent A. Reame**, Grand Rapids, MI (US);  
**Timothy J. Warwick**, Sparta, MI (US)

(57) **CLAIM**  
The ornamental design for an electrical power unit for a work surface, as shown and described.

**DESCRIPTION**

(\*\*) Term: **14 Years**

(21) Appl. No.: **29/452,252**

(22) Filed: **Apr. 15, 2013**

(51) **LOC (10) Cl.** ..... **13-03**

(52) **U.S. Cl.**

USPC ..... **D13/137.1**

(58) **Field of Classification Search**

USPC ..... D13/139.1, 107, 109, 110, 112, 114,  
D13/130, 131, 132, 133, 137, 137.1, 137.2,  
D13/137.3, 137.4, 138.1, 139.2, 139.4,  
D13/139.5, 139.7, 139.8, 146, 147, 151,  
D13/152, 160, 161, 162, 164, 199; D26/2,  
D26/3, 64, 75; 313/331, 357, 422; D14/304;  
D25/16

See application file for complete search history.

FIG. 1 is a perspective view of an electrical power unit for a work surface showing our new design;  
FIG. 2 is another perspective view of the electrical power unit of FIG. 1, shown with its fastening collar partially separated;  
FIG. 3 is a top plan view of the electrical power unit of FIG. 1, shown without the fastening collar;  
FIG. 4 is a bottom plan view of the electrical power unit of FIG. 1, shown without the fastening collar;  
FIG. 5 is a rear elevation of the electrical power unit of FIG. 1, shown without the fastening collar;  
FIG. 6 is a front elevation of the electrical power unit of FIG. 1, shown without the fastening collar;  
FIG. 7 is a right side elevation of the electrical power unit of FIG. 1, shown without the fastening collar;  
FIG. 8 is a left side elevation of the electrical power unit of FIG. 1, shown without the fastening collar;  
FIG. 9 is a top plan view of the electrical power unit of FIG. 1;  
FIG. 10 is a bottom plan view of the electrical power unit of FIG. 1;  
FIG. 11 is a rear elevation of the electrical power unit of FIG. 1;  
FIG. 12 is a front elevation of the electrical power unit of FIG. 1;  
FIG. 13 is a right side elevation of the electrical power unit of FIG. 1; and, FIG. 14 is a left side elevation of the electrical power unit of FIG. 1.

In the drawings, the broken lines depict unclaimed subject matter only and form no part of the claimed design.

**1 Claim, 4 Drawing Sheets**

(56) **References Cited**

**U.S. PATENT DOCUMENTS**

D78,966 S 7/1929 Conner  
D162,509 S \* 3/1951 Austin ..... D8/350  
D195,463 S 6/1963 Tamarin  
4,463,998 A \* 8/1984 Reavis et al. .... 439/137

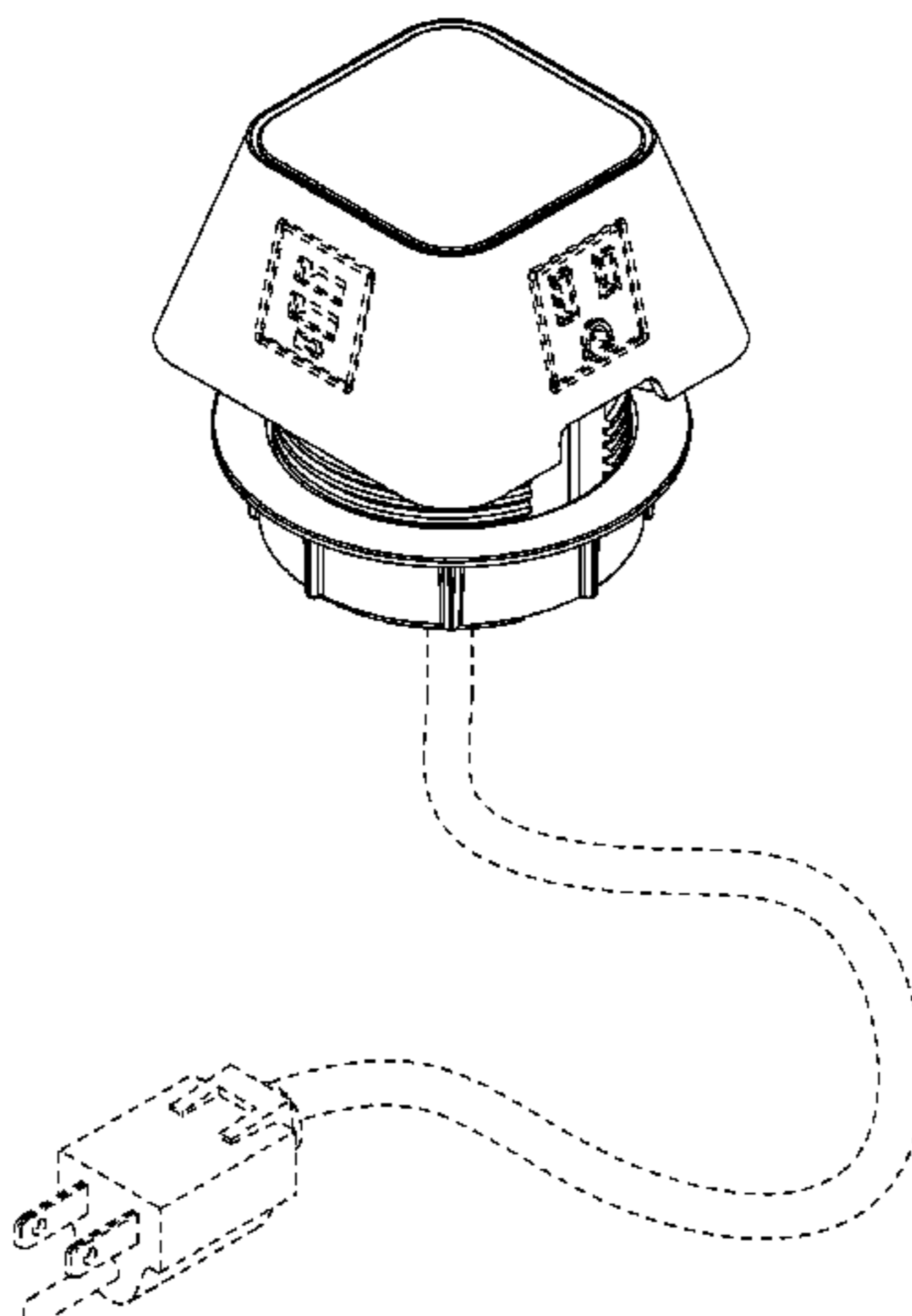

(56)

**References Cited**

U.S. PATENT DOCUMENTS

D409,980 S	5/1999	Byrne	6,717,053 B2	4/2004	Rupert
D418,815 S	1/2000	Byrne	6,875,051 B2	4/2005	Pizak
6,081,356 A	6/2000	Branc et al.	7,112,097 B1	9/2006	Lam
6,580,388 B1 *	6/2003	Stoyanov et al. ....	D653,215 S	1/2012	Lam
		342/192	2006/0258195 A1	11/2006	Schwartz et al.
			2007/0275594 A1	11/2007	Greenberg
					* cited by examiner

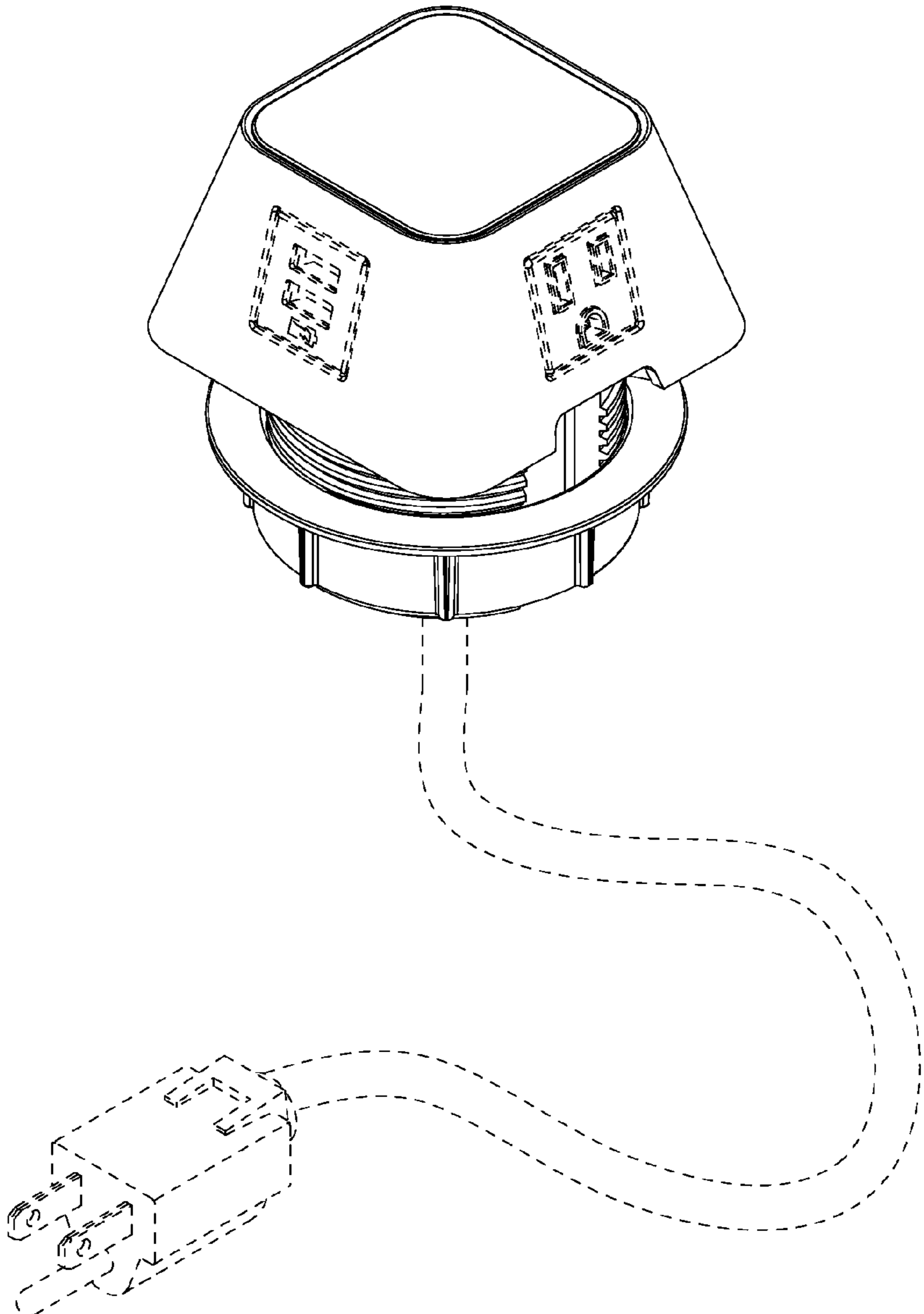

FIG. 1

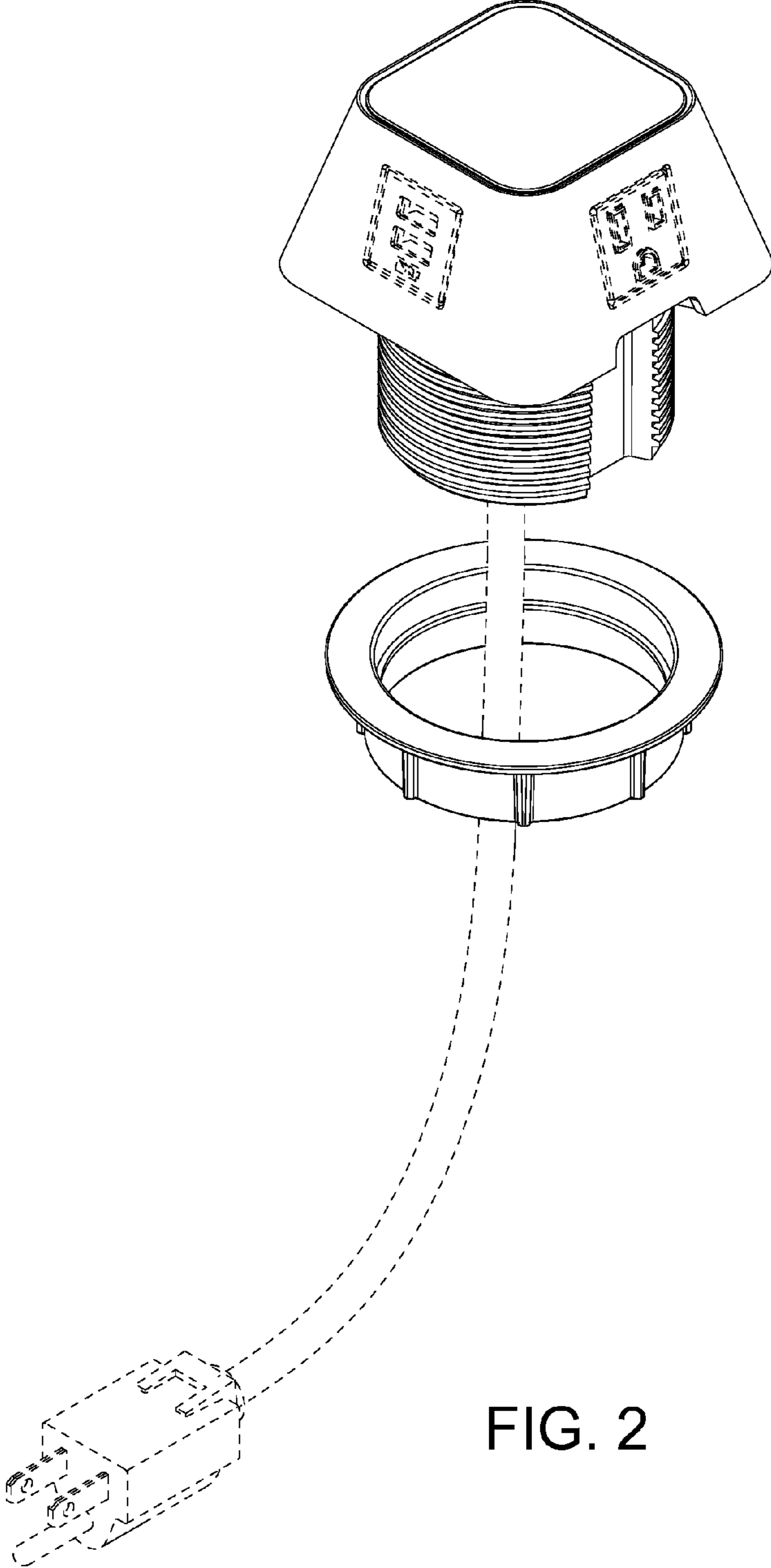

FIG. 2

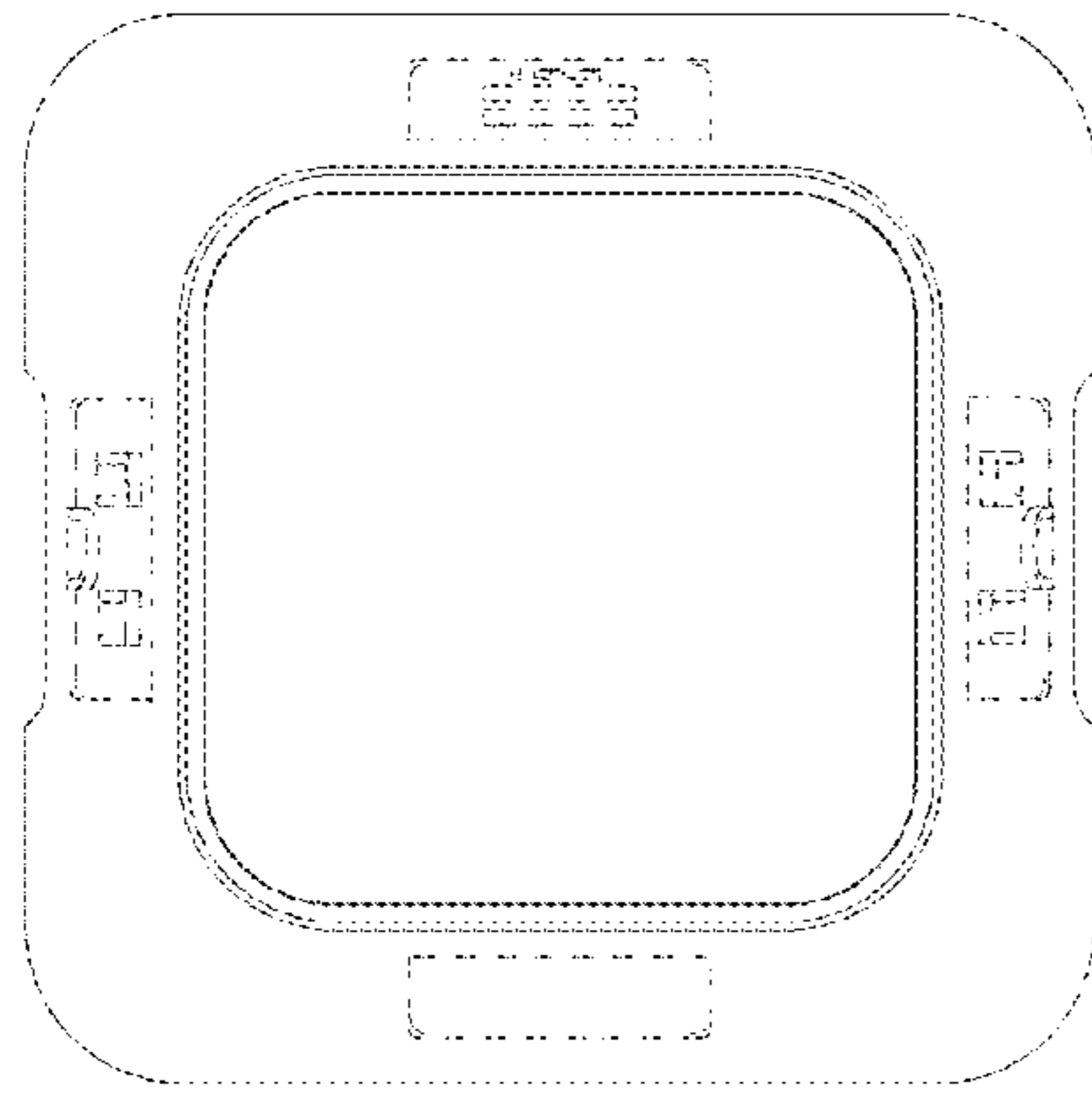

FIG. 3

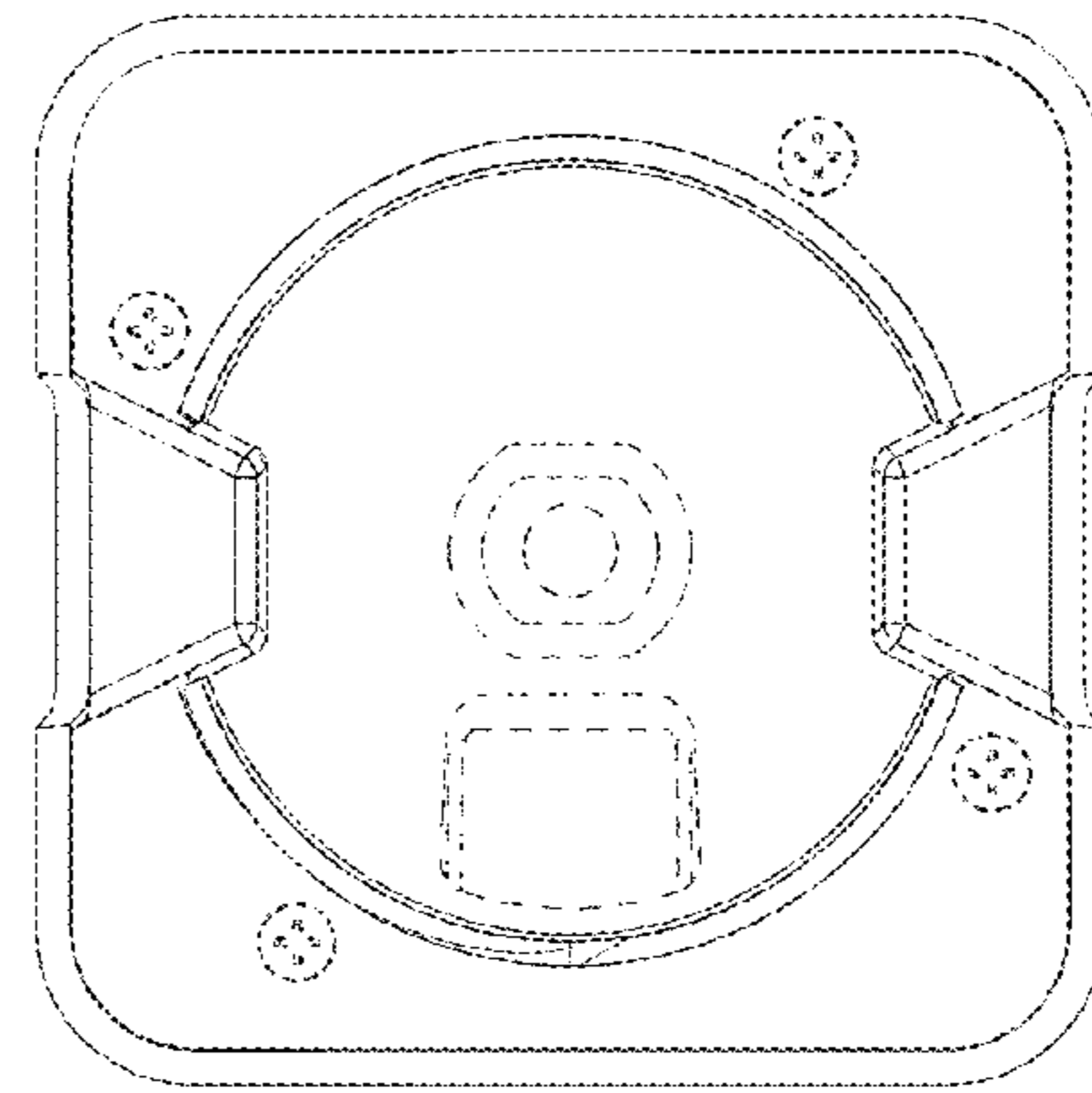

FIG. 4

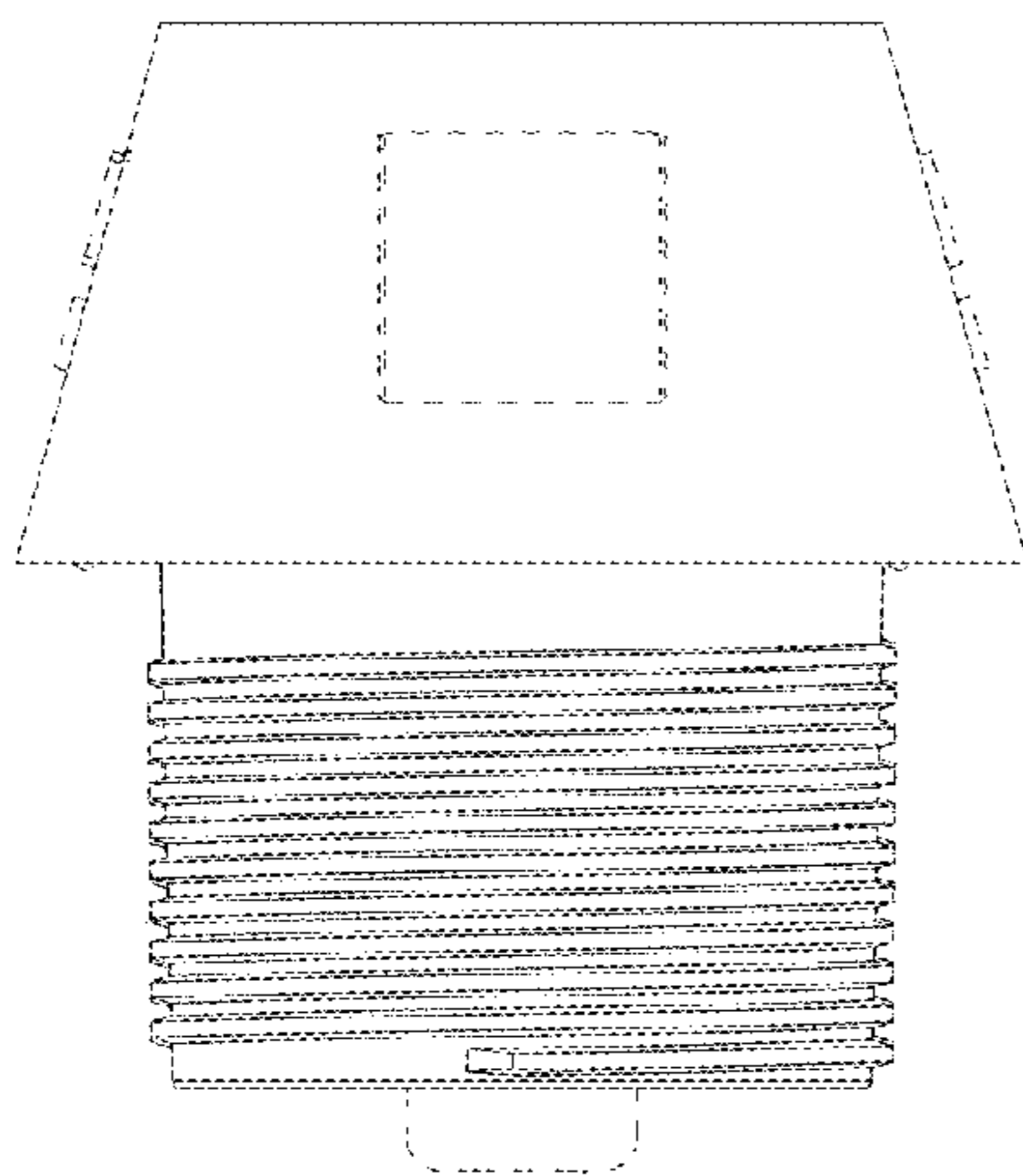

FIG. 5

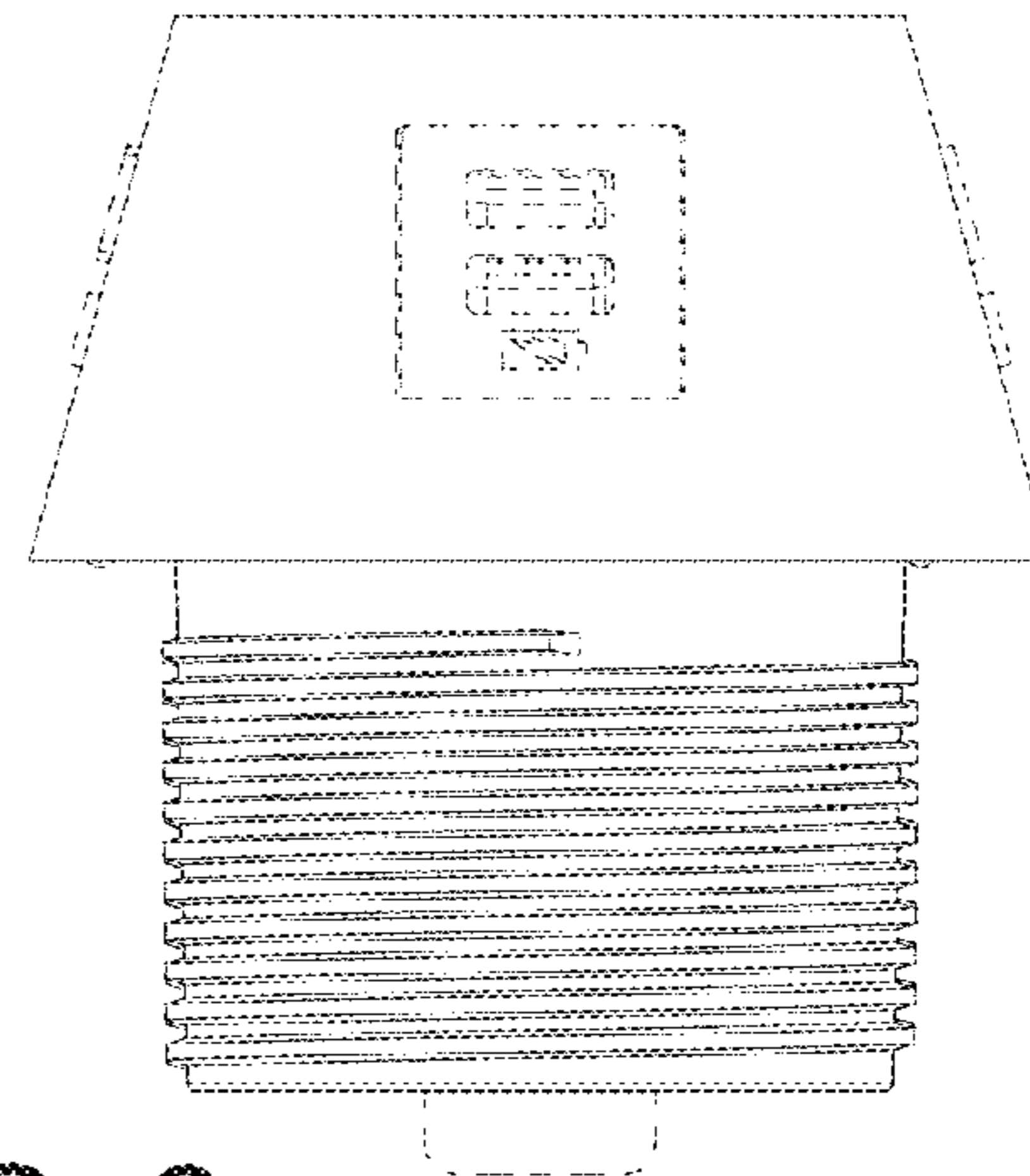

FIG. 6

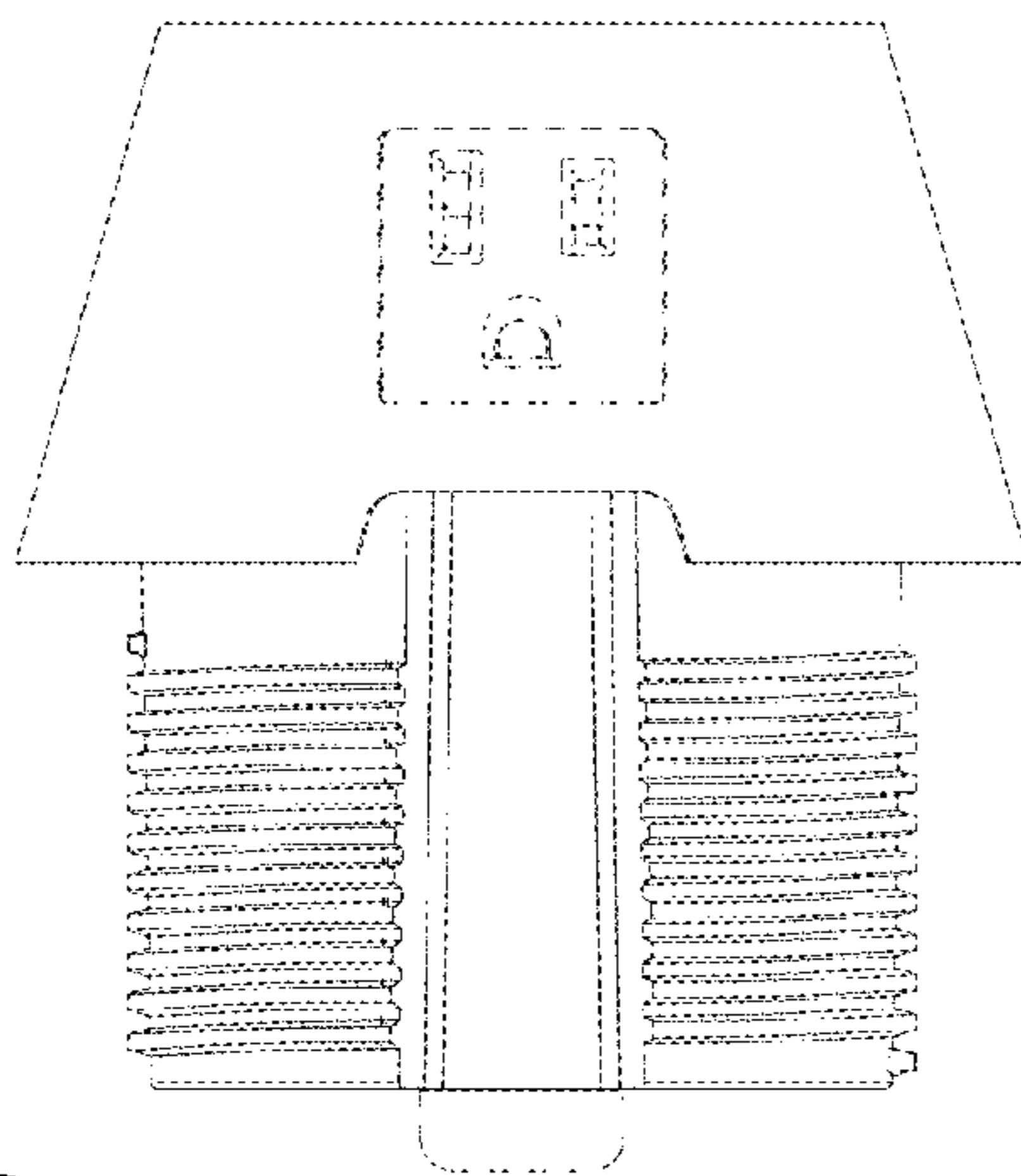

FIG. 7

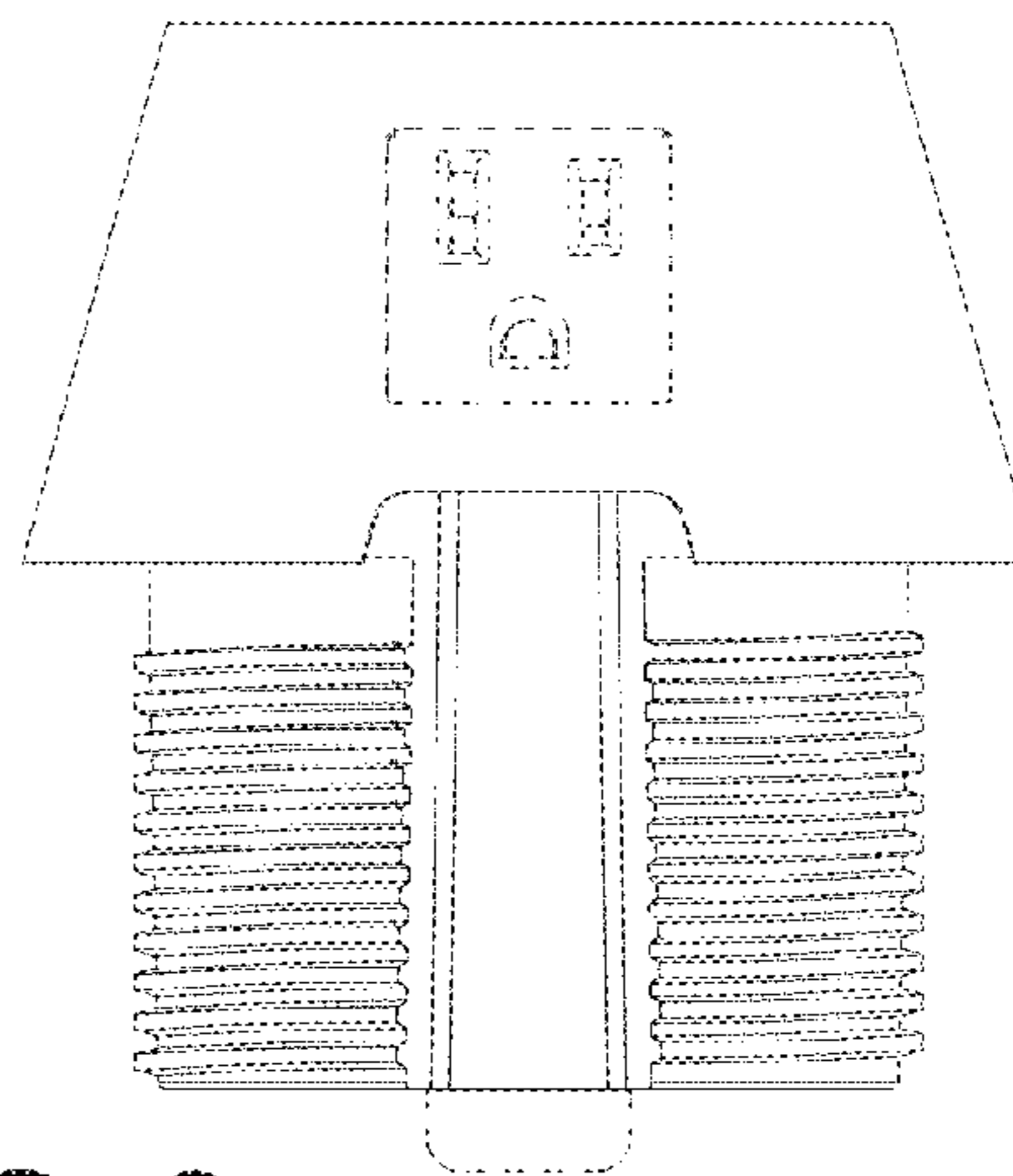

FIG. 8

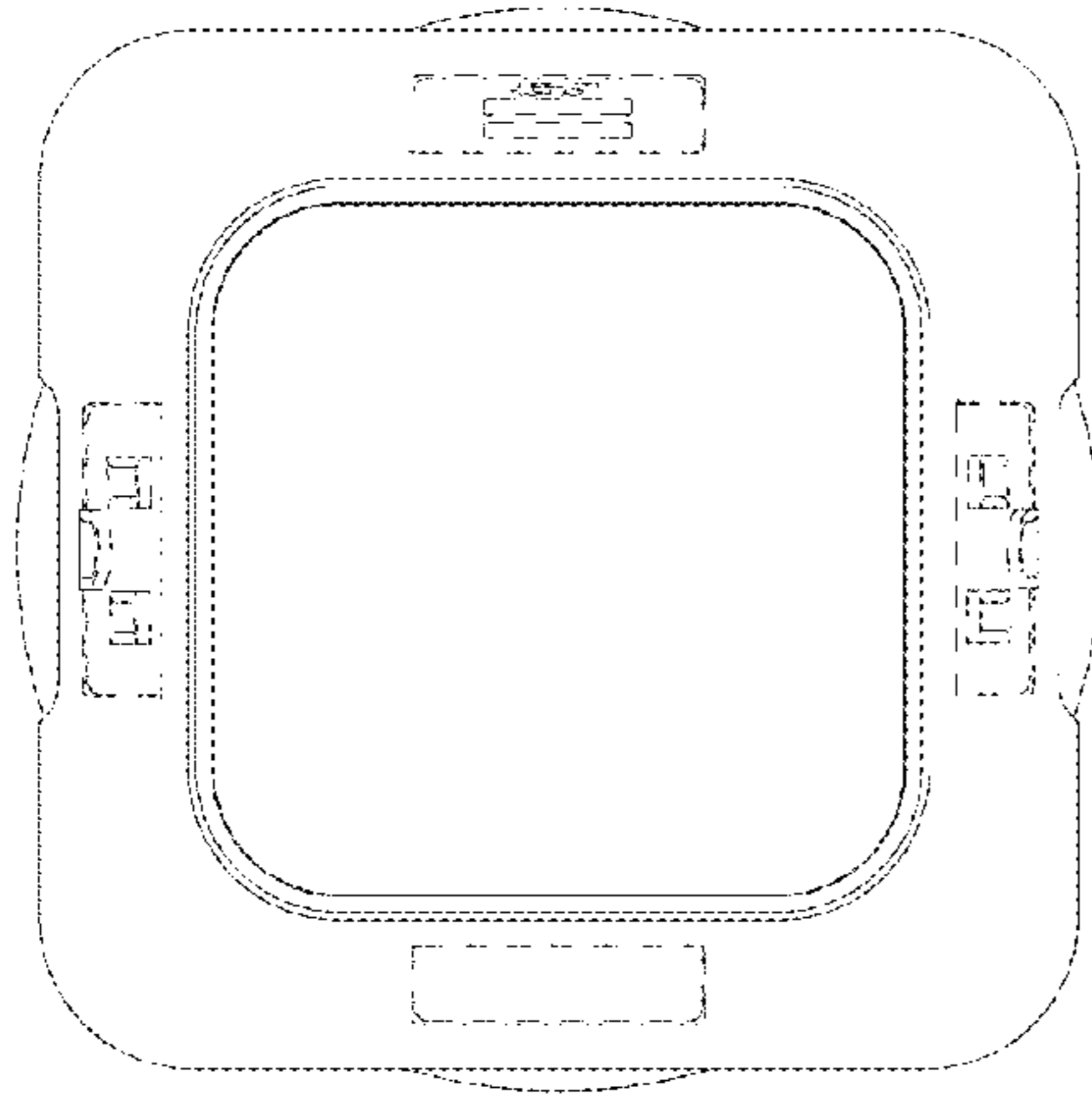

FIG. 9

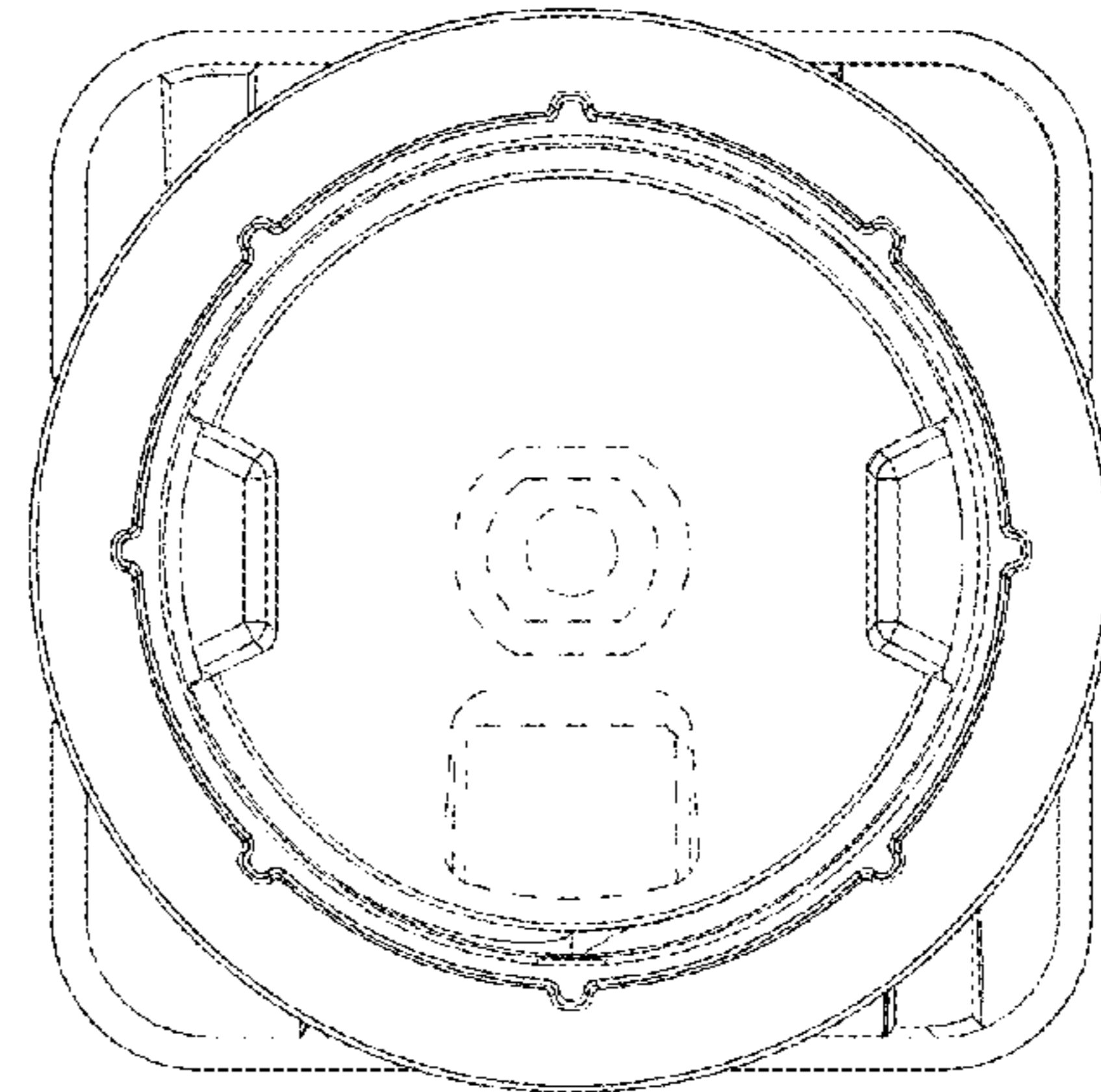

FIG. 10

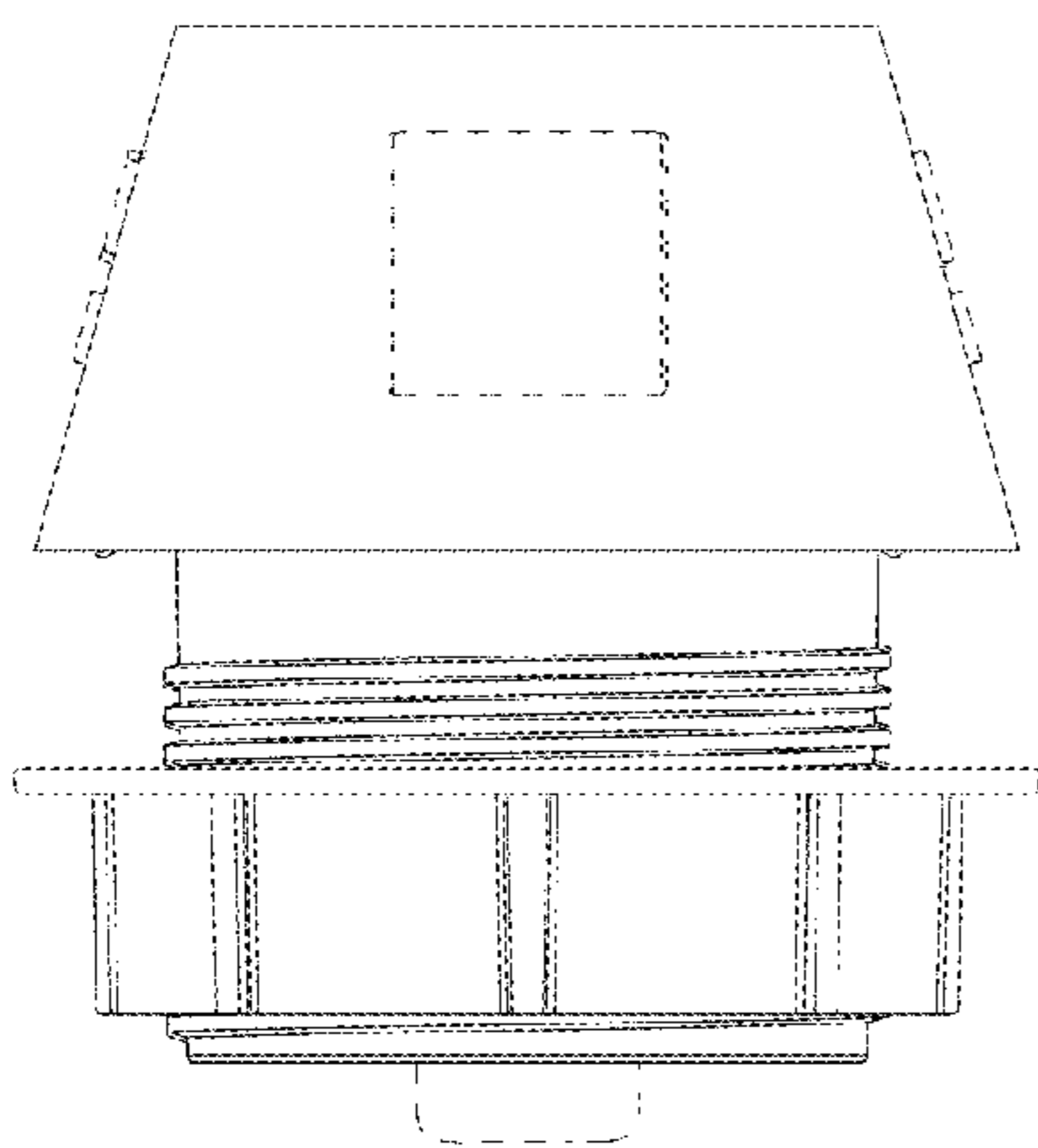

FIG. 11

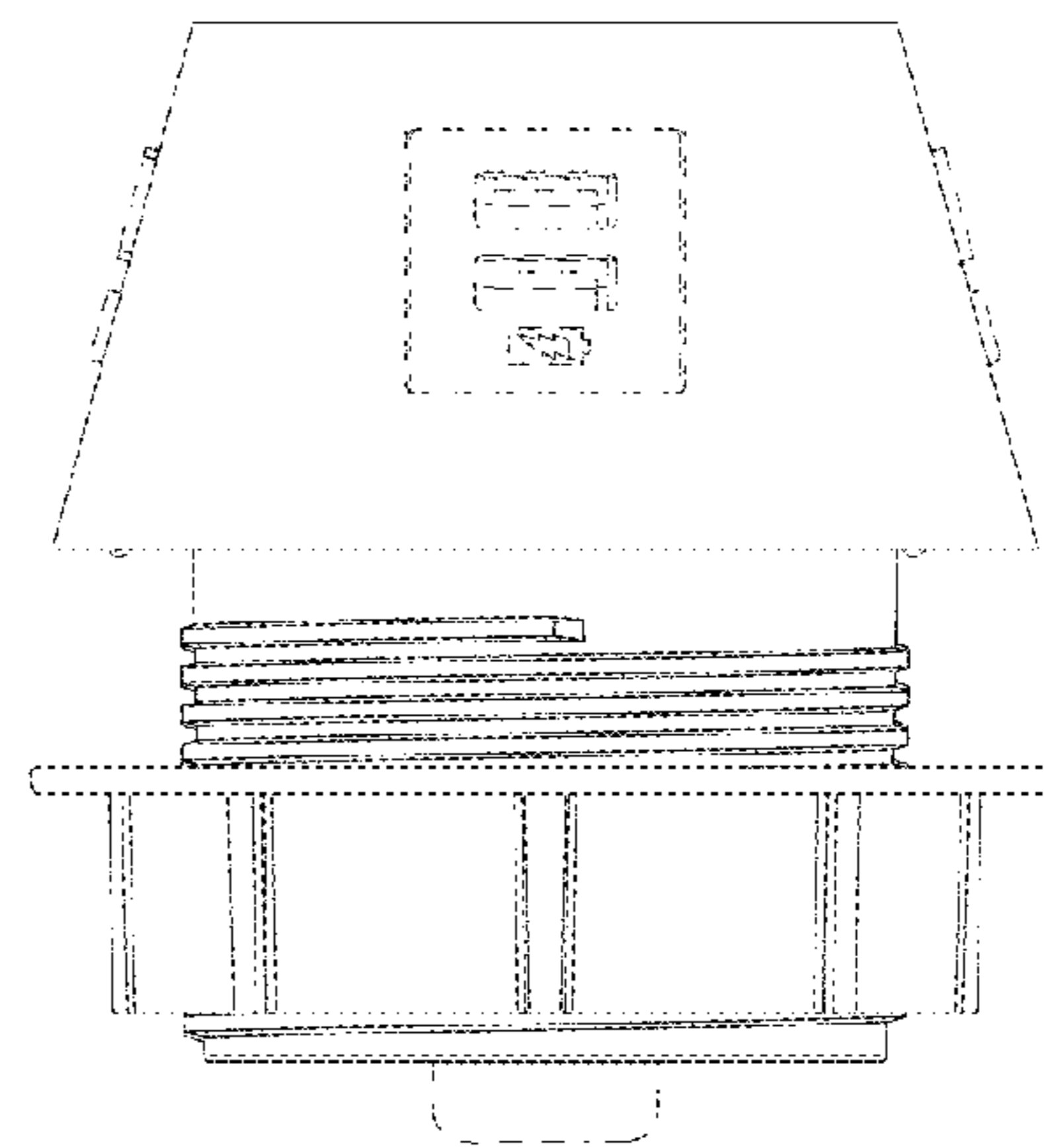

FIG. 12

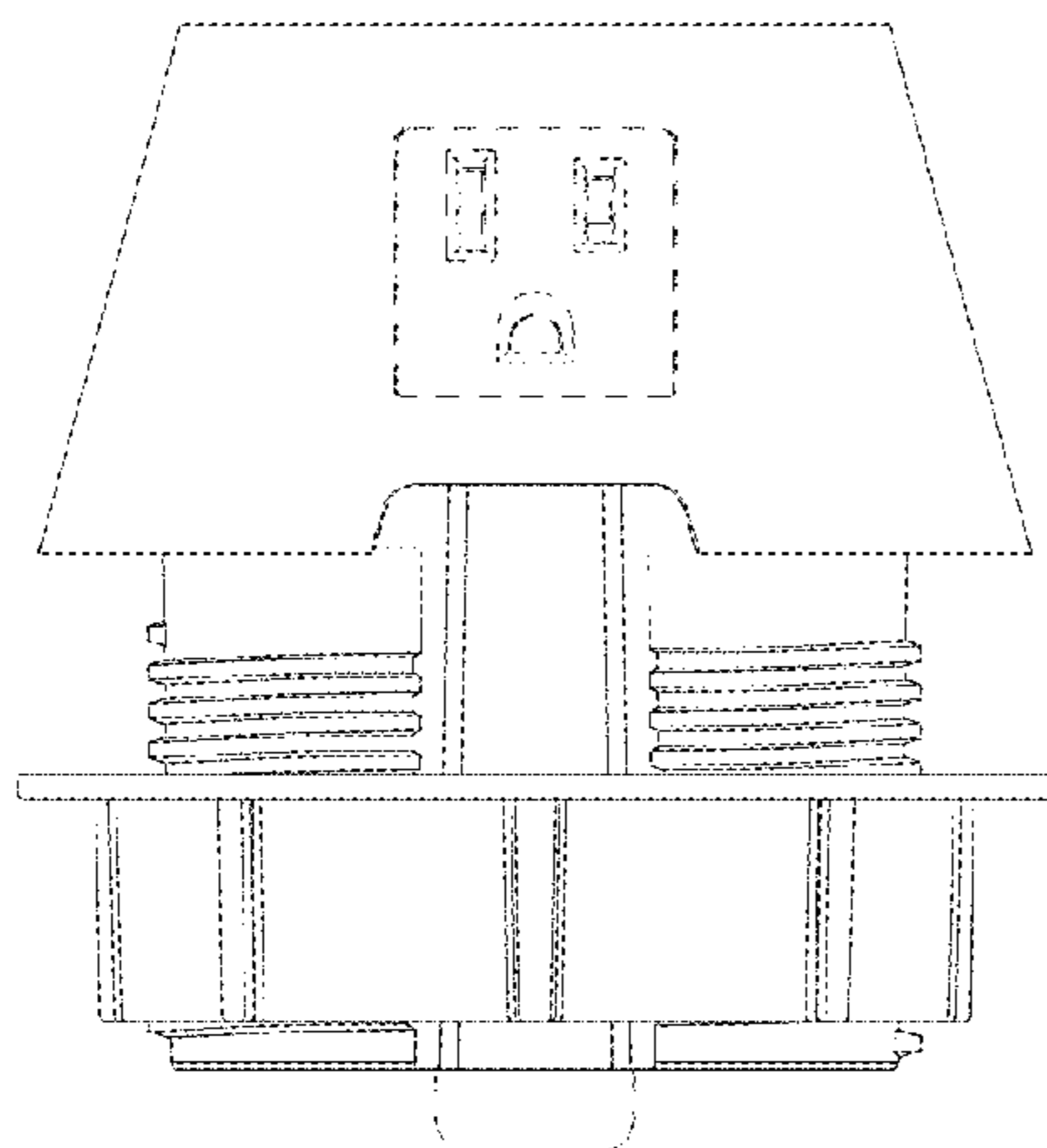

FIG. 13

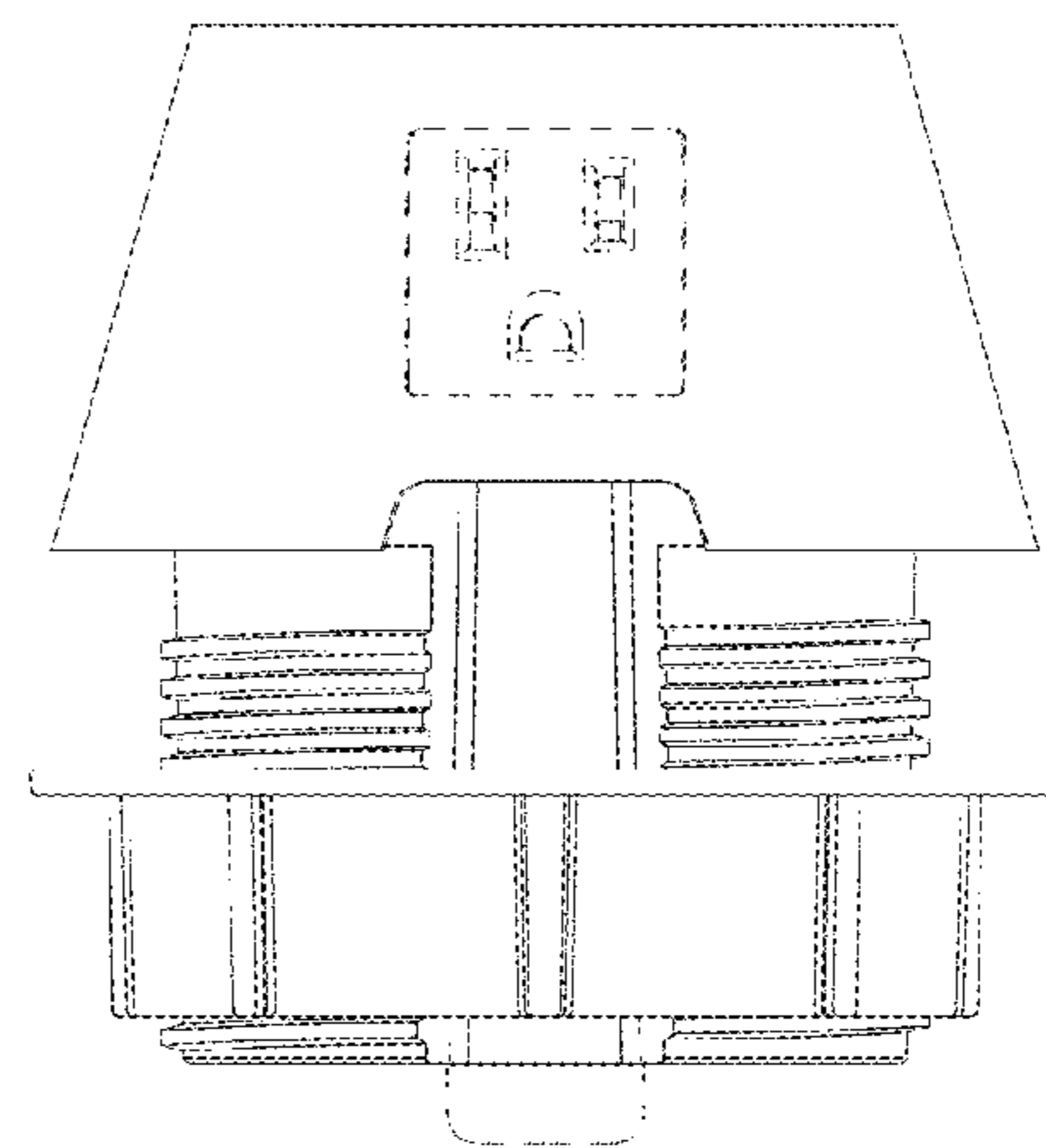

FIG. 14