



US00D717720S

(12) **United States Design Patent**
Marino

(10) **Patent No.:** **US D717,720 S**

(45) **Date of Patent:** **** Nov. 18, 2014**

(54) **DECORATIVE ROOFTOP CARRIER**

(71) Applicant: **Steven F. Marino**, Collingswood, NJ
(US)

(72) Inventor: **Steven F. Marino**, Collingswood, NJ
(US)

(**) Term: **14 Years**

(21) Appl. No.: **29/481,856**

(22) Filed: **Feb. 11, 2014**

(51) **LOC (10) Cl.** **12-16**

(52) **U.S. Cl.**
USPC **D12/413**

(58) **Field of Classification Search**
USPC D12/414.1, 414, 413, 412, 221, 406,
D12/157, 423; D6/552, 317-319, 513-514;
D3/304-306; 293/37.1, 3, 100;
296/39.1, 39.2, 37.6, 26.09, 99.1,
296/100.02, 157; 220/771; 224/309-311,
224/323-329, 273, 42.42, 400-404, 539,
224/542, 315-317, 510, 543, 544, 924;
414/462; 280/848, 727, 769; 206/213,
206/8, 9, 279, 290, 713, 335, 315.1-315.4;
32/35, 58

See application file for complete search history.

(56) **References Cited**

U.S. PATENT DOCUMENTS

2,812,992 A 11/1957 Lysen
3,464,579 A 9/1969 Ausenbauer

3,915,362 A 10/1975 Hart
4,071,176 A 1/1978 Tuzee
4,117,964 A 10/1978 Sage et al.
4,247,026 A 1/1981 Heifner et al.
D637,138 S * 5/2011 Ehrat D12/413
D641,303 S * 7/2011 Gruner D12/413
D642,970 S * 8/2011 Elder et al. D12/413
D643,798 S * 8/2011 Gruner D12/413
D656,083 S * 3/2012 Mukai D12/519
D669,018 S * 10/2012 Ehrat D12/413
2011/0084102 A1* 4/2011 Sautter et al. 224/316
2011/0084104 A1* 4/2011 Long 224/328
2012/0292358 A1* 11/2012 Brej et al. 224/309

* cited by examiner

Primary Examiner — Katrina A Betton

(74) *Attorney, Agent, or Firm* — Robert C. Montgomery;
Montgomery Patent & Design

(57) **CLAIM**

The ornamental design for a decorative rooftop carrier, as shown and described.

DESCRIPTION

FIG. 1 is a perspective view of a decorative rooftop carrier;
FIG. 2 is a front view thereof;
FIG. 3 is a rear view thereof;
FIG. 4 is a left-hand side view thereof;
FIG. 5 is a right-hand side view thereof;
FIG. 6 is a top view thereof; and,
FIG. 7 is a bottom view thereof.

1 Claim, 7 Drawing Sheets

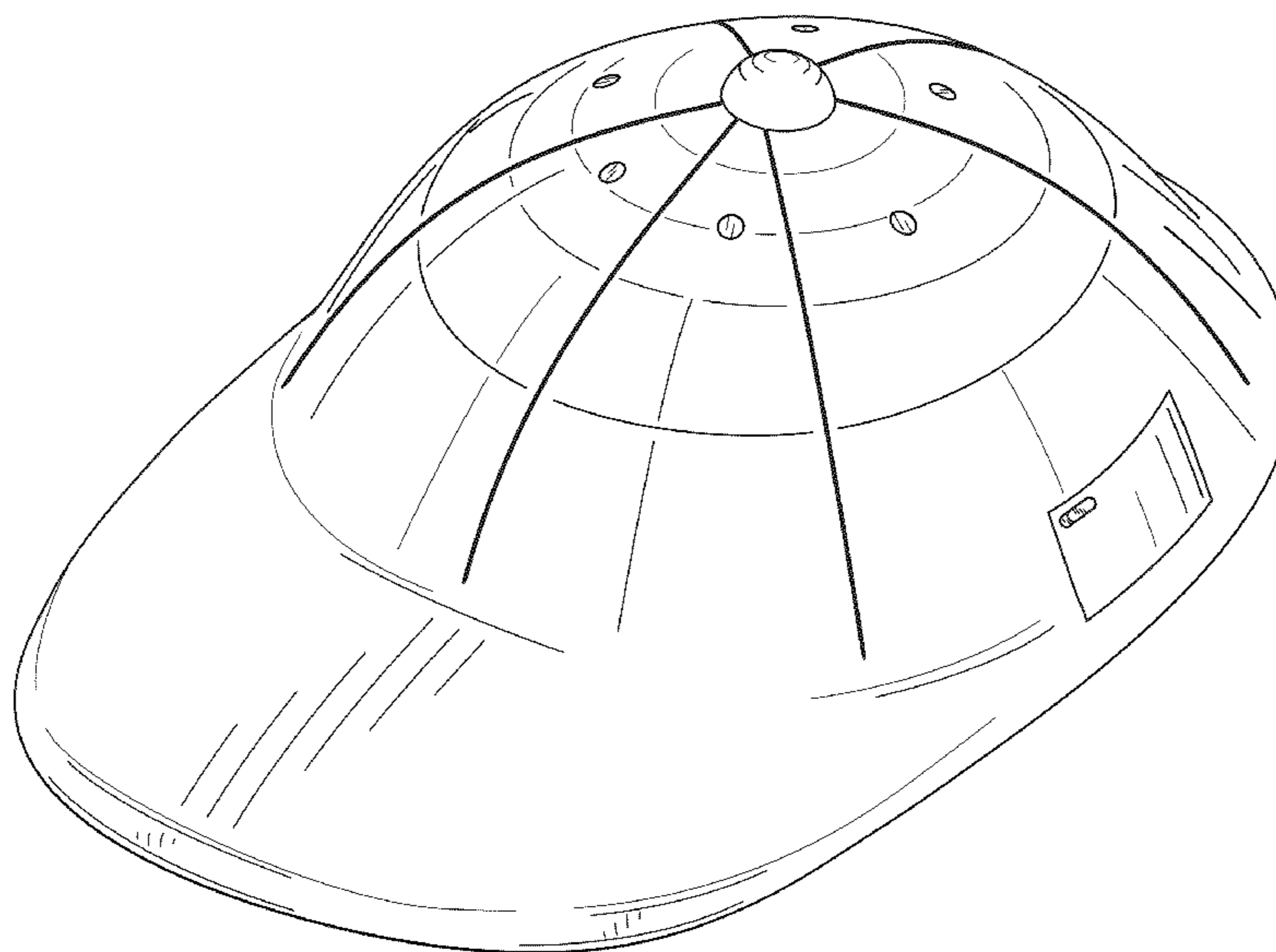

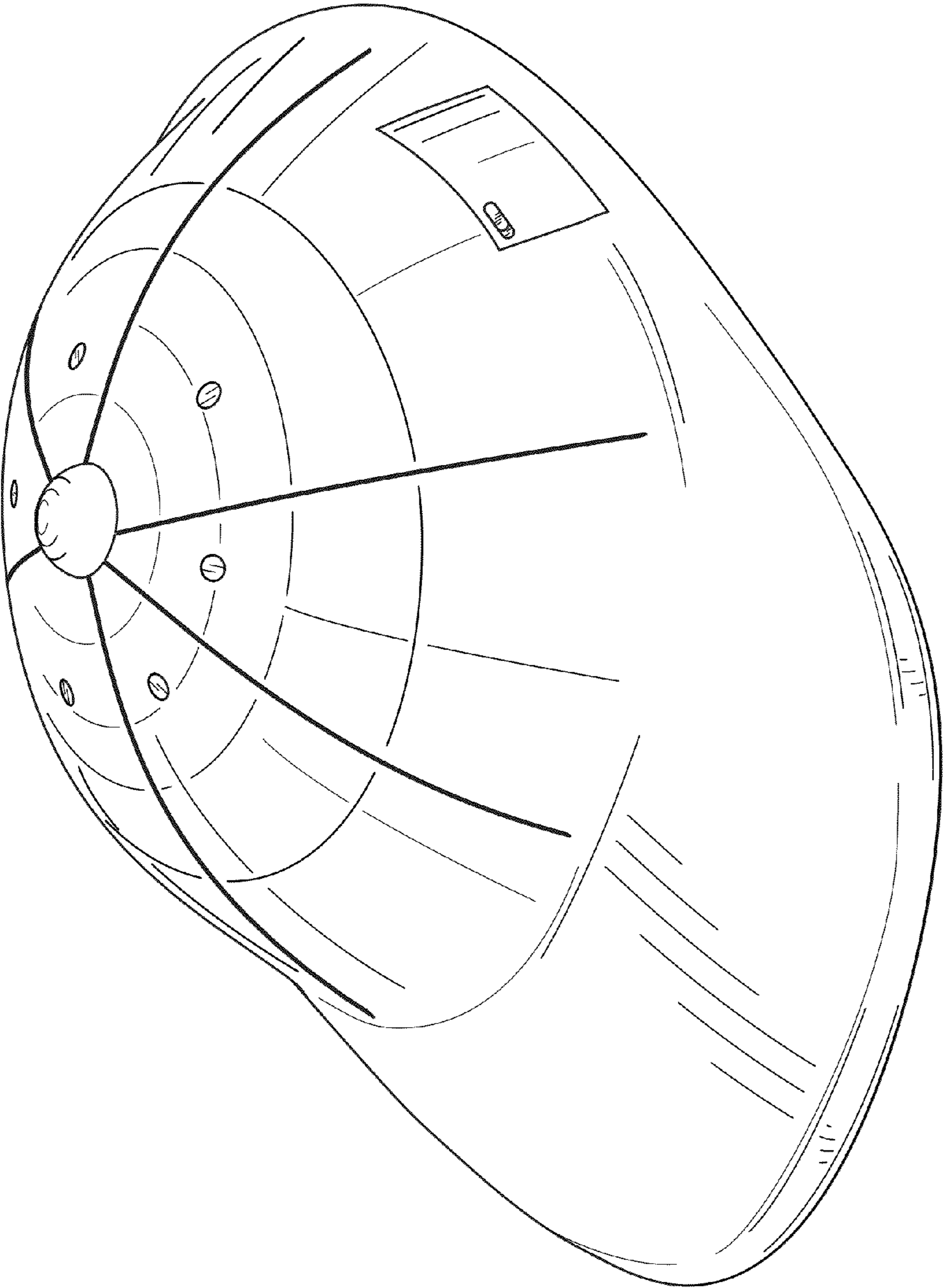

Fig. 1

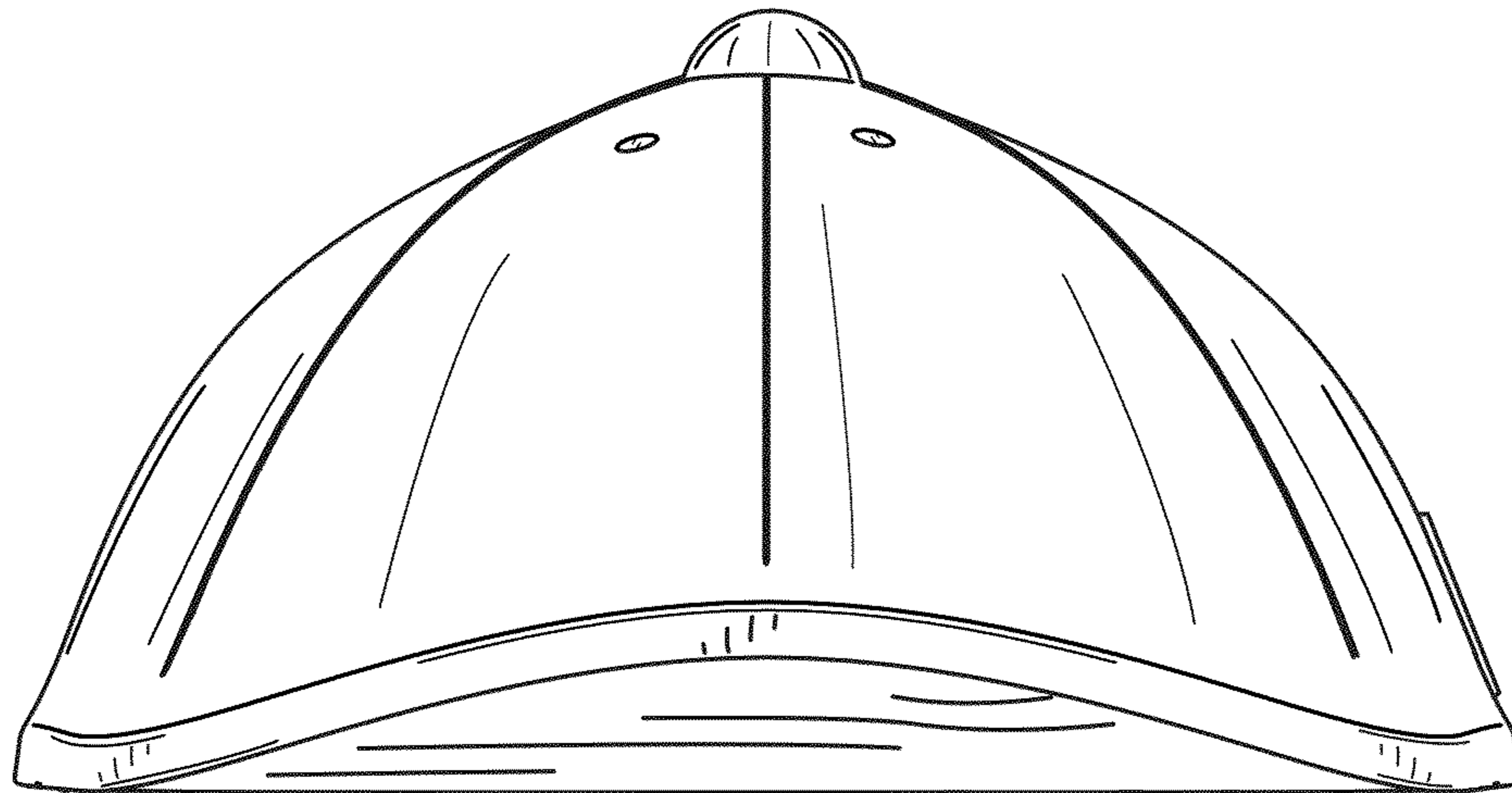

Fig. 2

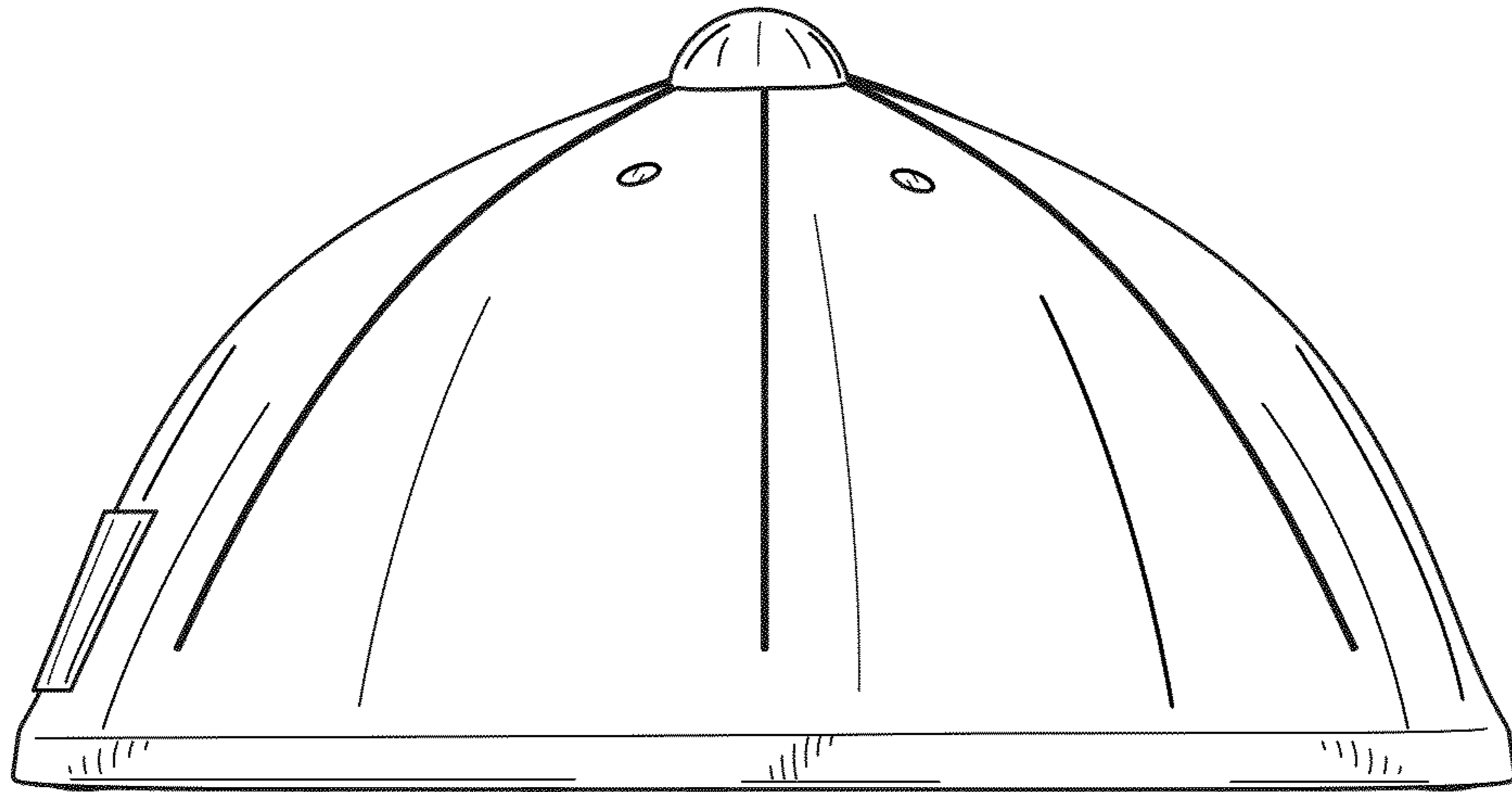

Fig. 3

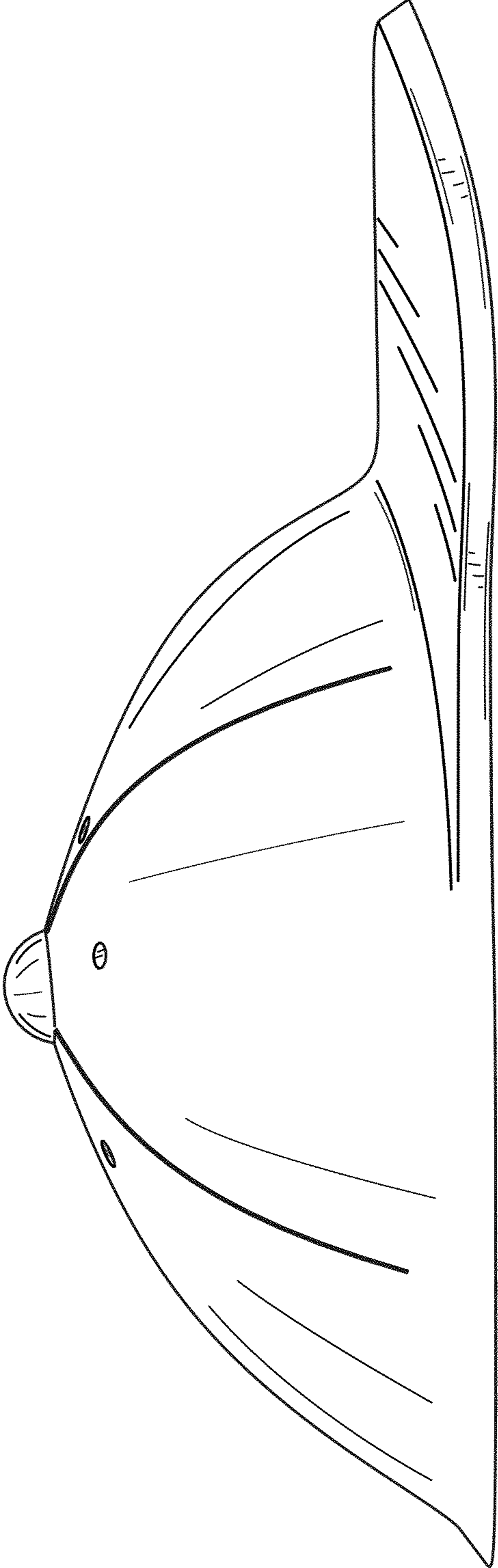

Fig. 4

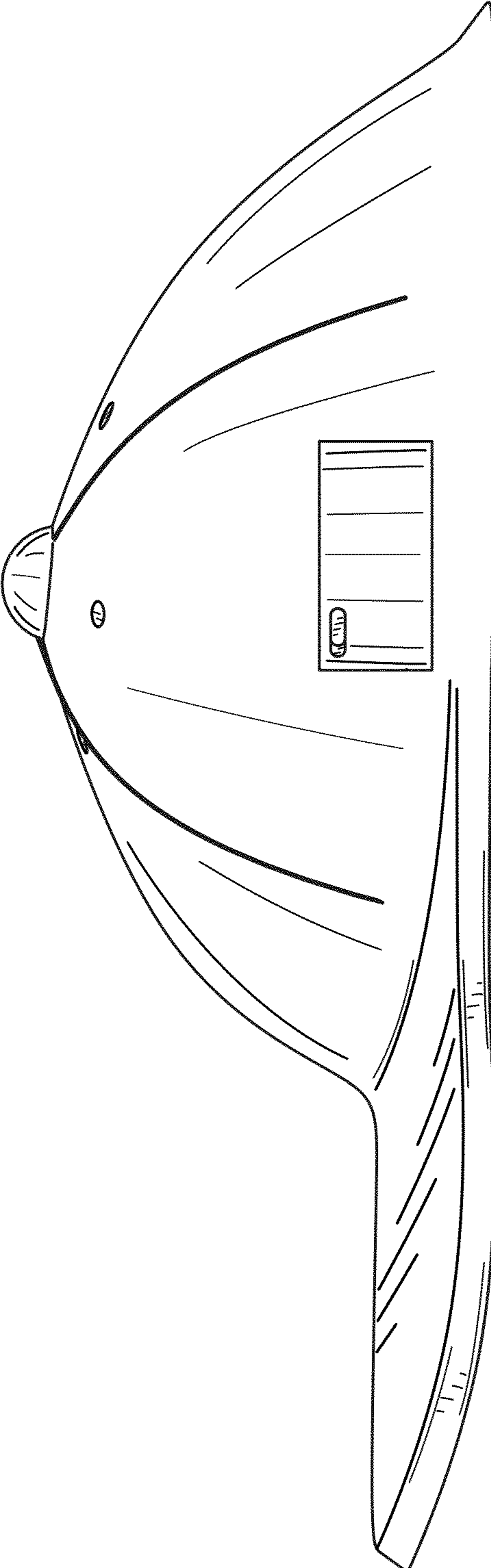

Fig. 5

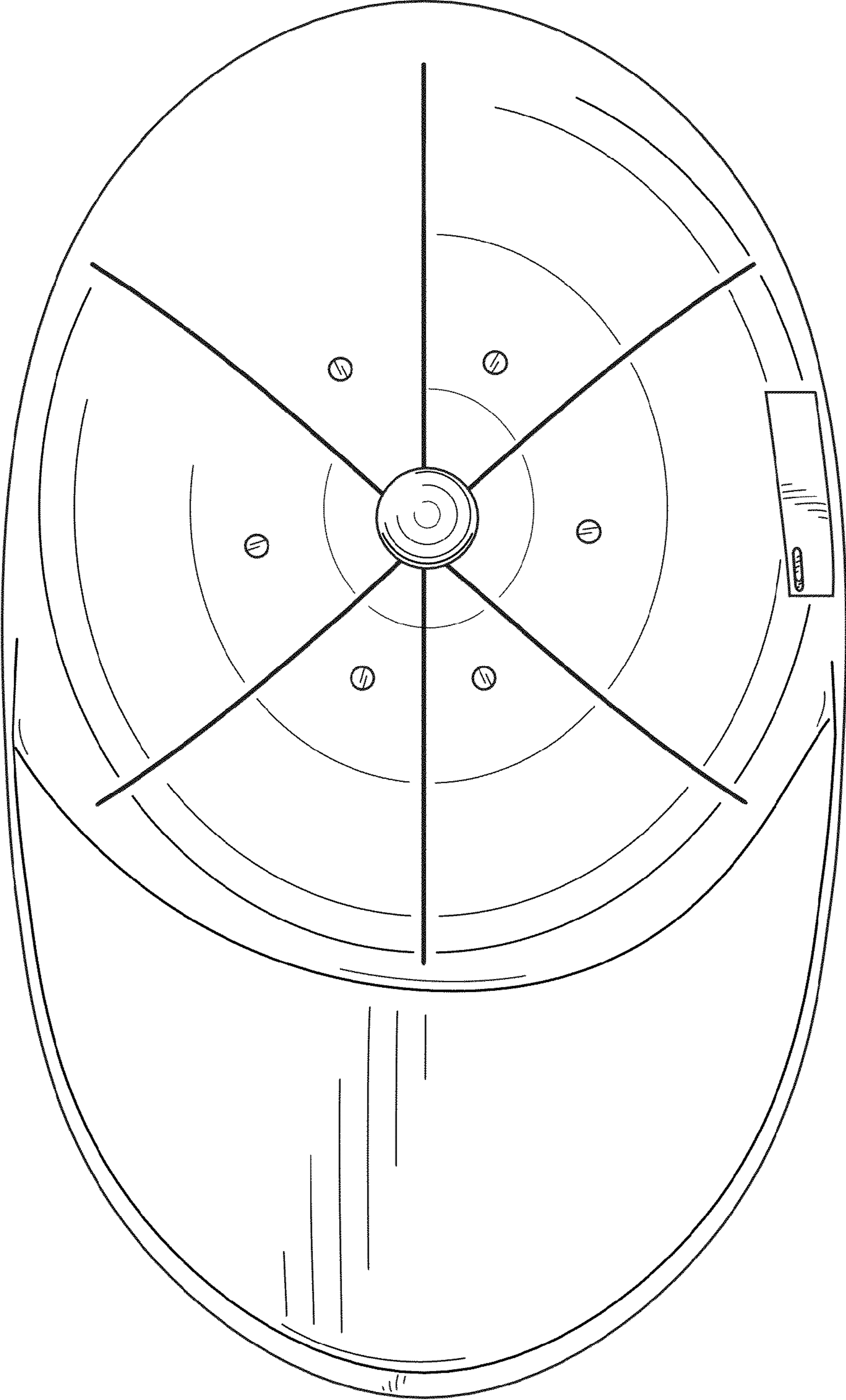

Fig. 6

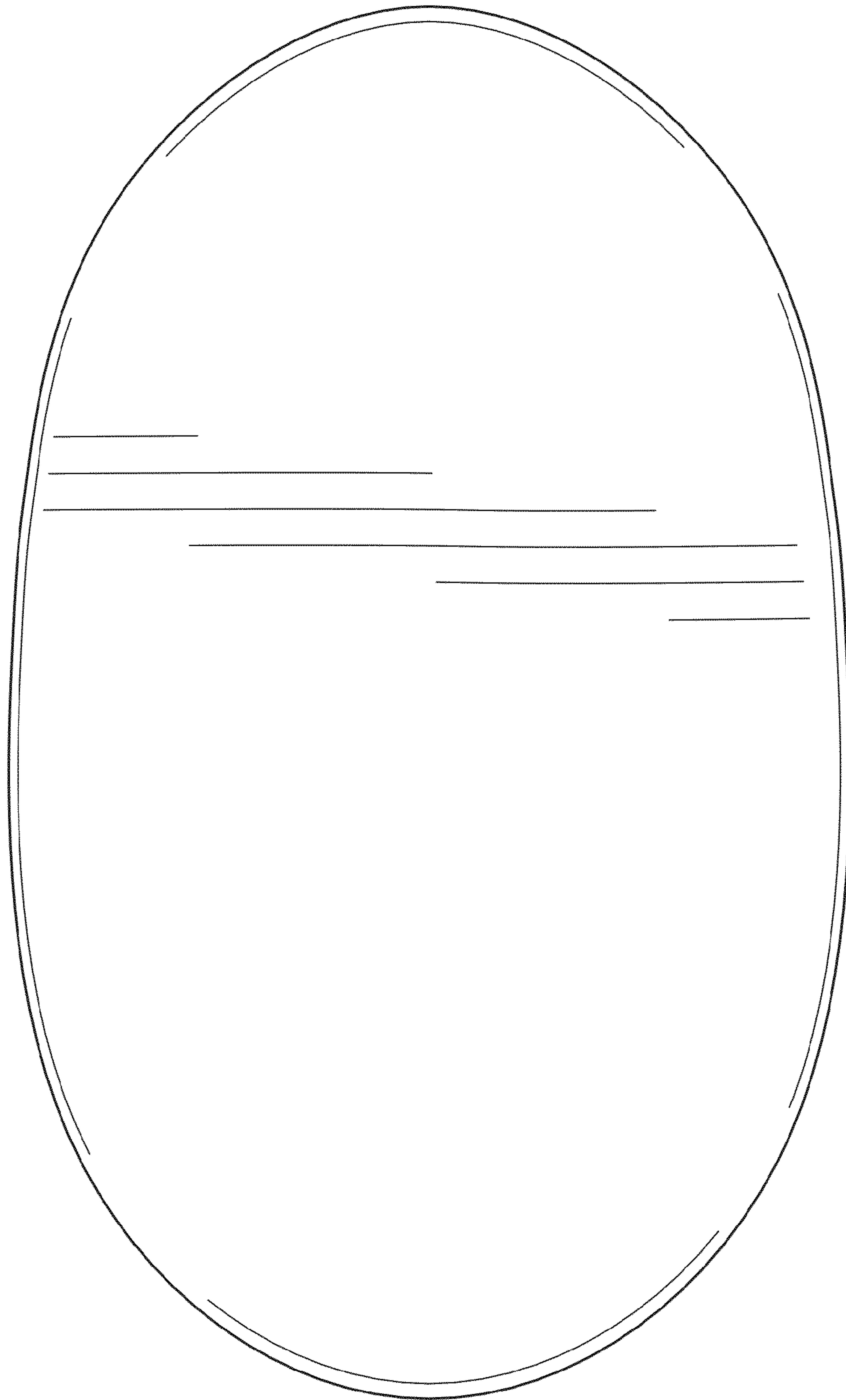

Fig. 7