



US00D717617S

(12) **United States Design Patent**
Pascuzzo

(10) **Patent No.:** **US D717,617 S**

(45) **Date of Patent:** **** Nov. 18, 2014**

(54) **TREE SUPPORT BLOCK**

(71) Applicant: **Thomas P. Pascuzzo**, Lake Worth, FL
(US)

(72) Inventor: **Thomas P. Pascuzzo**, Lake Worth, FL
(US)

(**) Term: **14 Years**

(21) Appl. No.: **29/483,773**

(22) Filed: **Mar. 3, 2014**

(51) **LOC (10) Cl.** **08-01**

(52) **U.S. Cl.**
USPC **D8/1; D8/354**

(58) **Field of Classification Search**
USPC D8/1, 349, 354; 47/42, 43; 248/524,
248/528

See application file for complete search history.

(56) **References Cited**

U.S. PATENT DOCUMENTS

2,501,255	A	5/1946	Bell	
4,520,590	A	6/1985	Schuh	
5,402,600	A	4/1995	Tompkins	
5,465,529	A *	11/1995	Park	47/40.5

5,590,865	A	1/1997	Odom, Jr.	
D407,626	S *	4/1999	Costello	D8/349
5,950,359	A	9/1999	Pivnik	
6,370,817	B1	4/2002	Brooks et al.	
D468,252	S *	1/2003	Morris	D12/223
6,612,071	B1	9/2003	Steadman	
D548,571	S *	8/2007	Bigelow et al.	D8/349
D627,212	S *	11/2010	Hikoyama	D8/380
8,407,934	B1	4/2013	Solares	
2009/0119984	A1	5/2009	Nabhan	

* cited by examiner

Primary Examiner — Sheryl Lane

(74) *Attorney, Agent, or Firm* — Mark D. Bowen; Malin
Haley DiMaggio & Bowen, P.A.

(57) **CLAIM**

The ornamental design for a tree support block, as shown and described.

DESCRIPTION

FIG. 1 is a front perspective view of a tree support block in accordance with the present invention; FIG. 2 is a right side view thereof; FIG. 3 is a bottom view thereof; FIG. 4 is a top view thereof; FIG. 5 is a front view thereof; and, FIG. 6 is a rear view thereof.

1 Claim, 4 Drawing Sheets

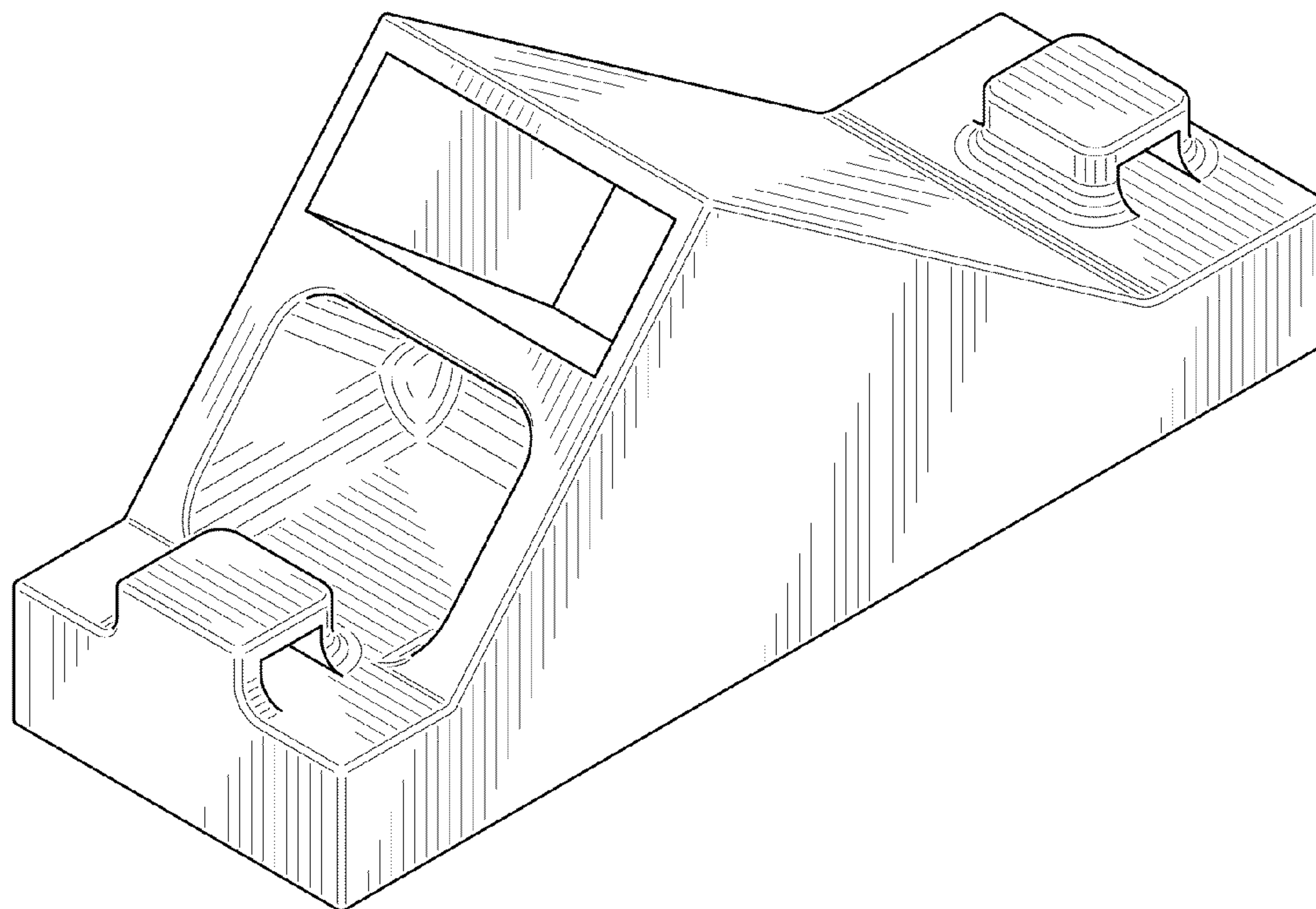

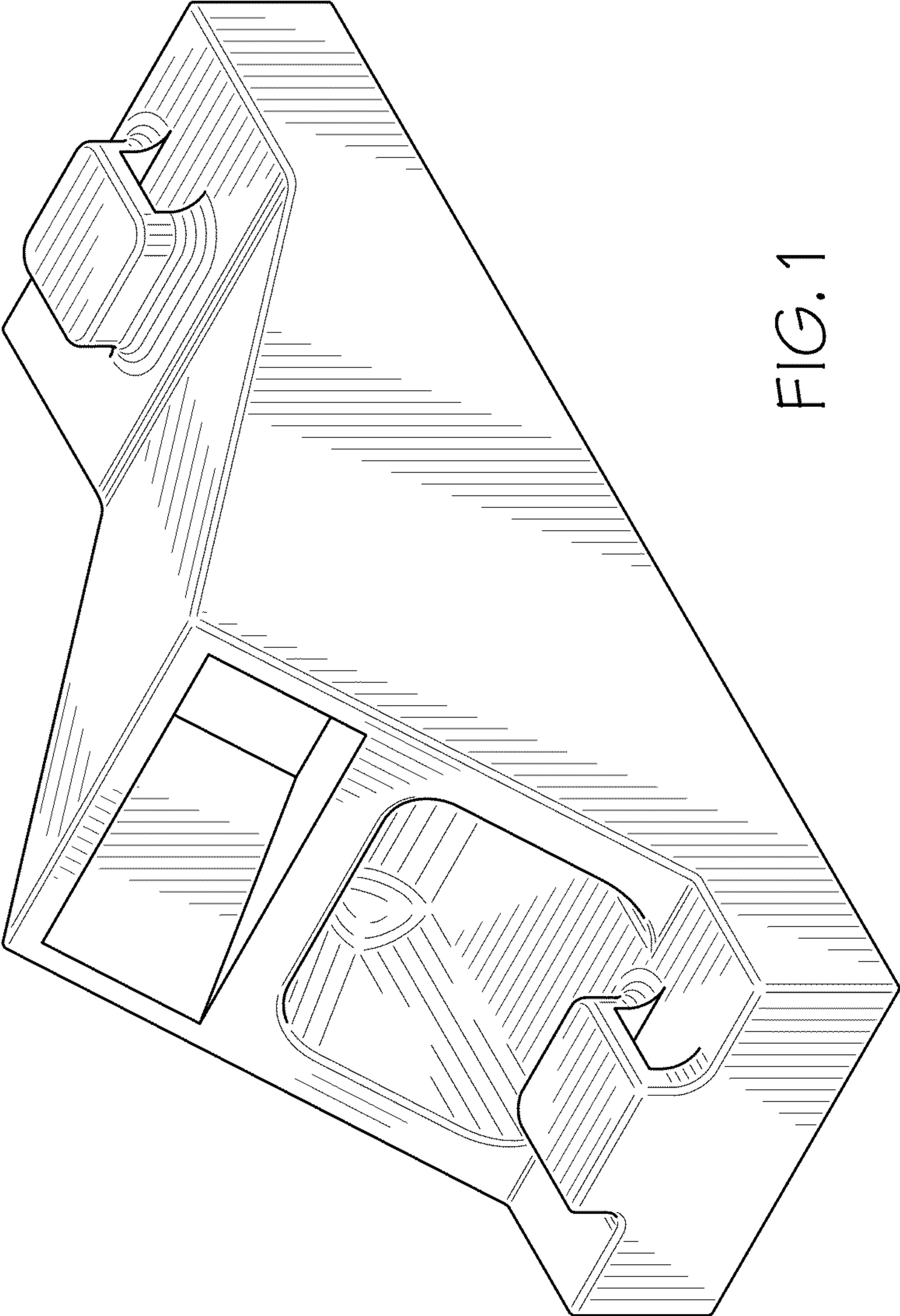

FIG. 1

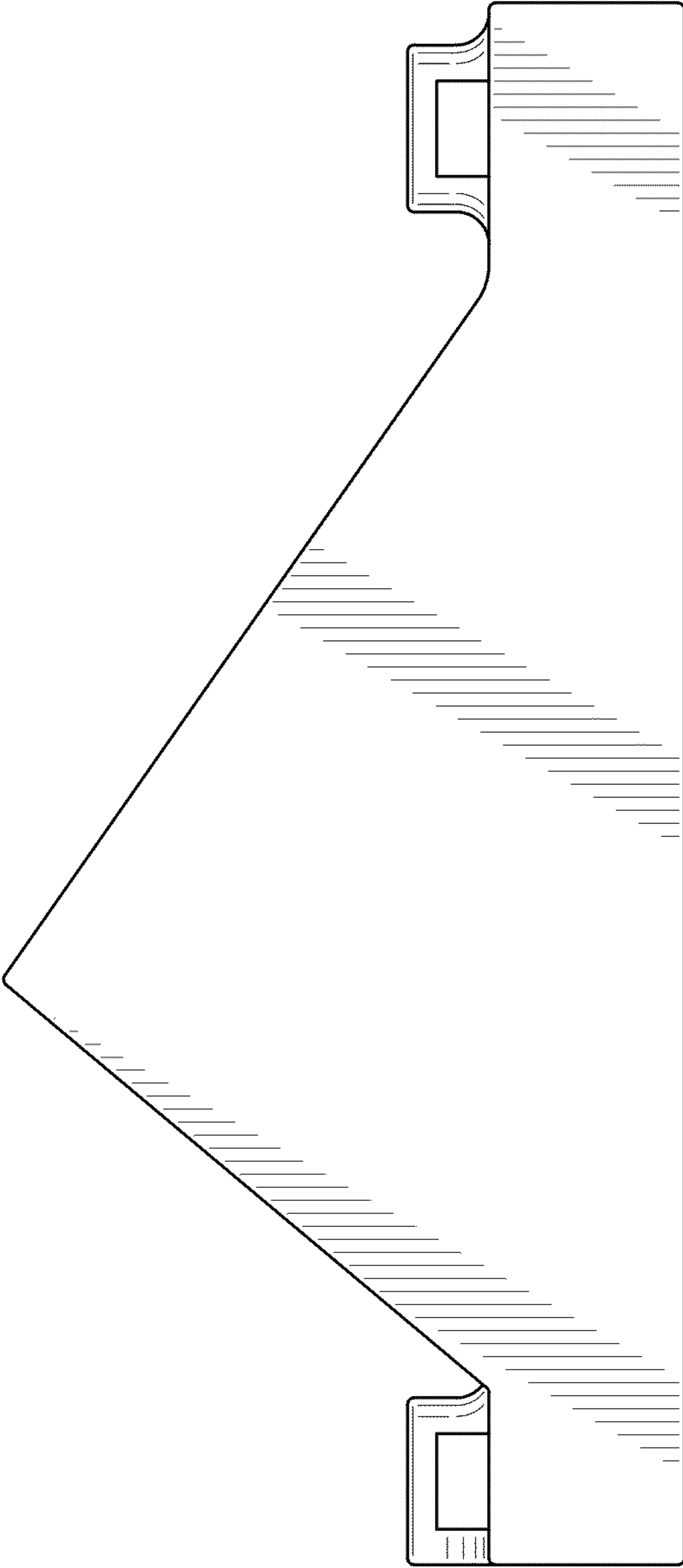

FIG. 2

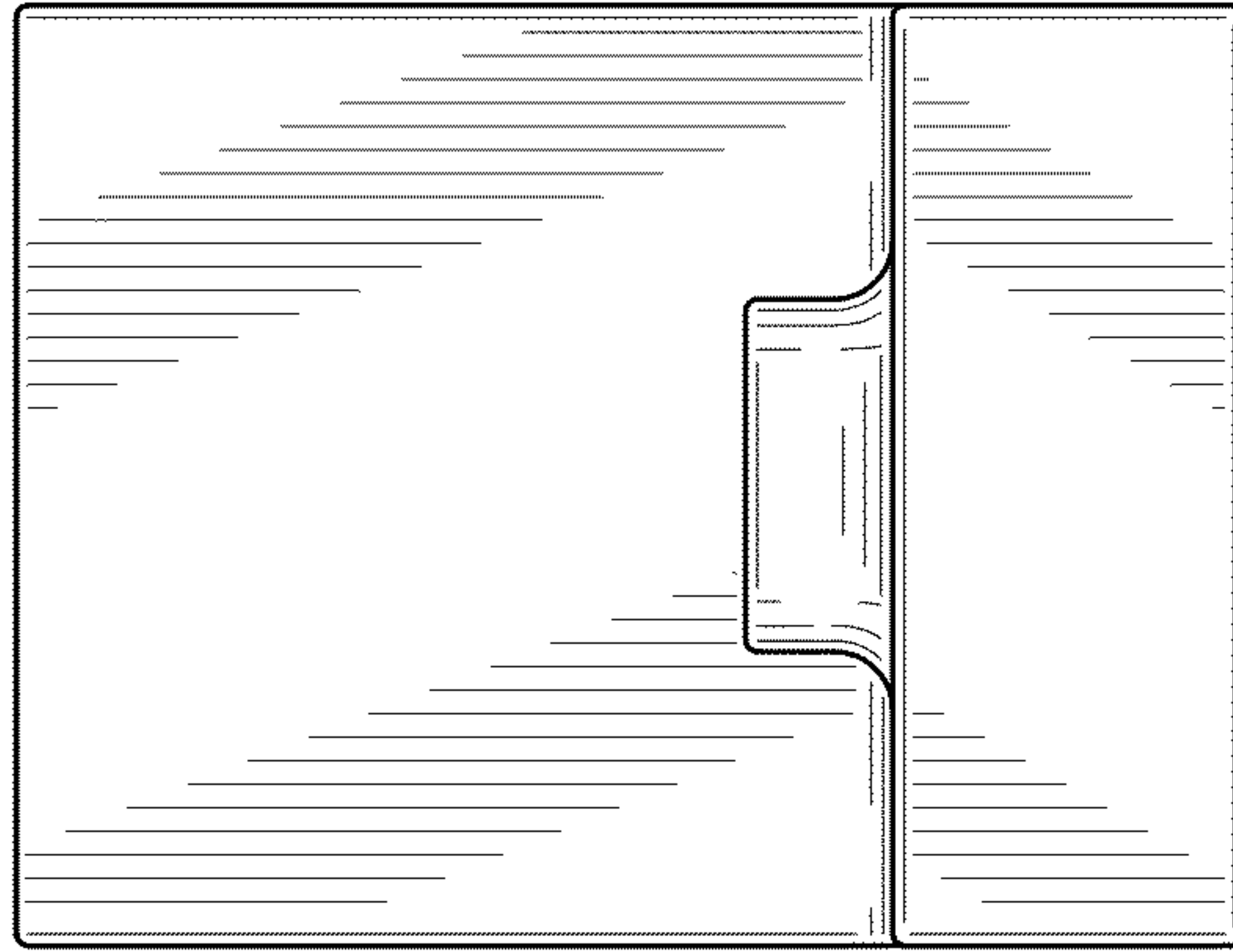

FIG. 4

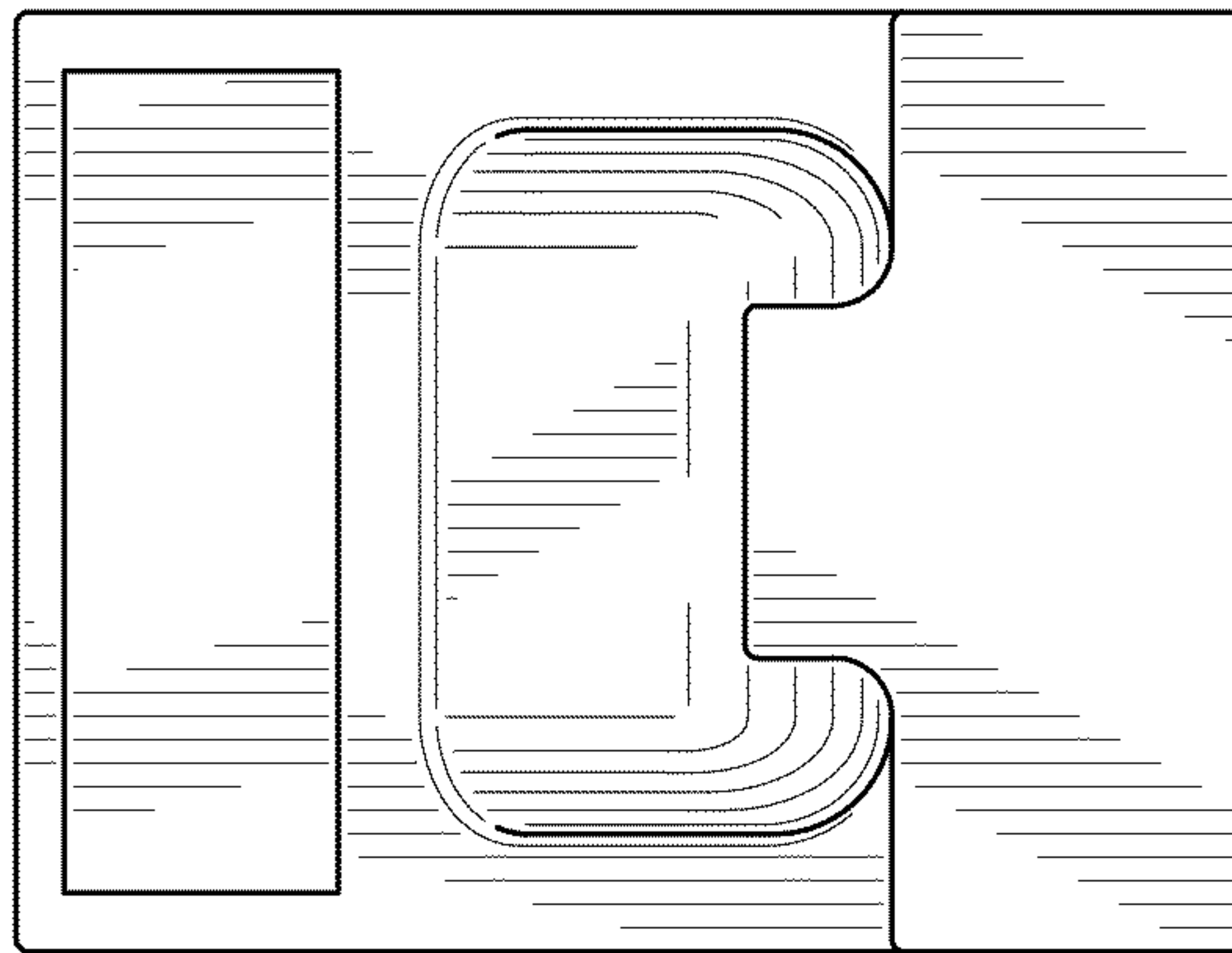

FIG. 3

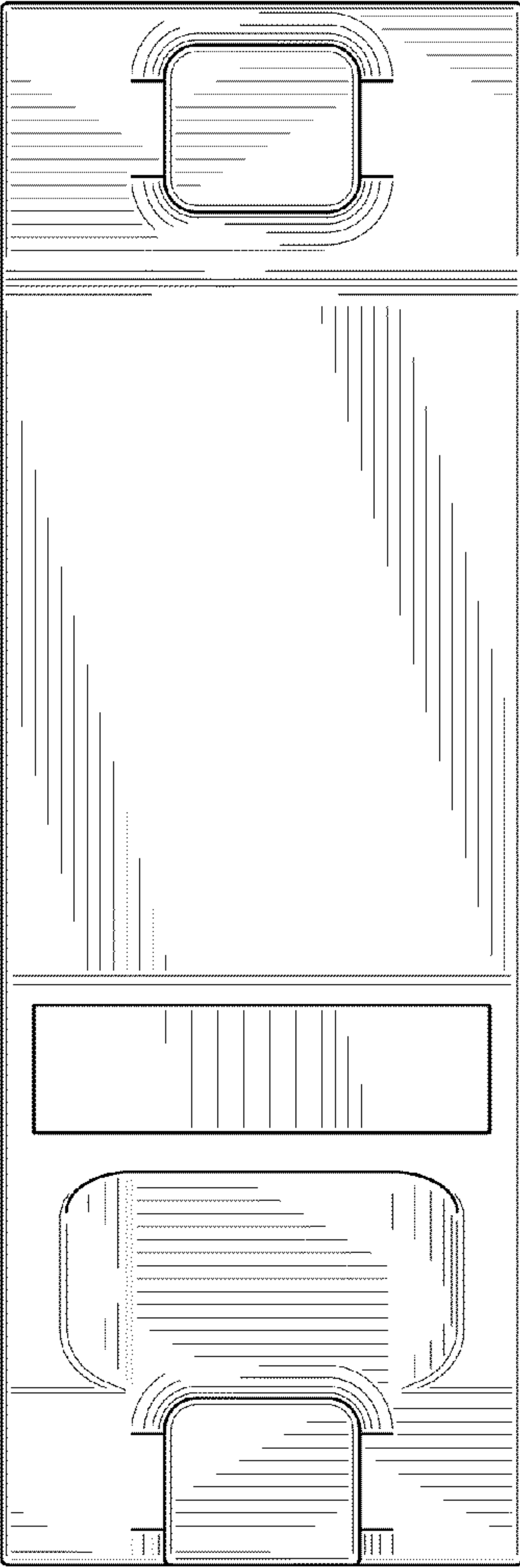

FIG. 5

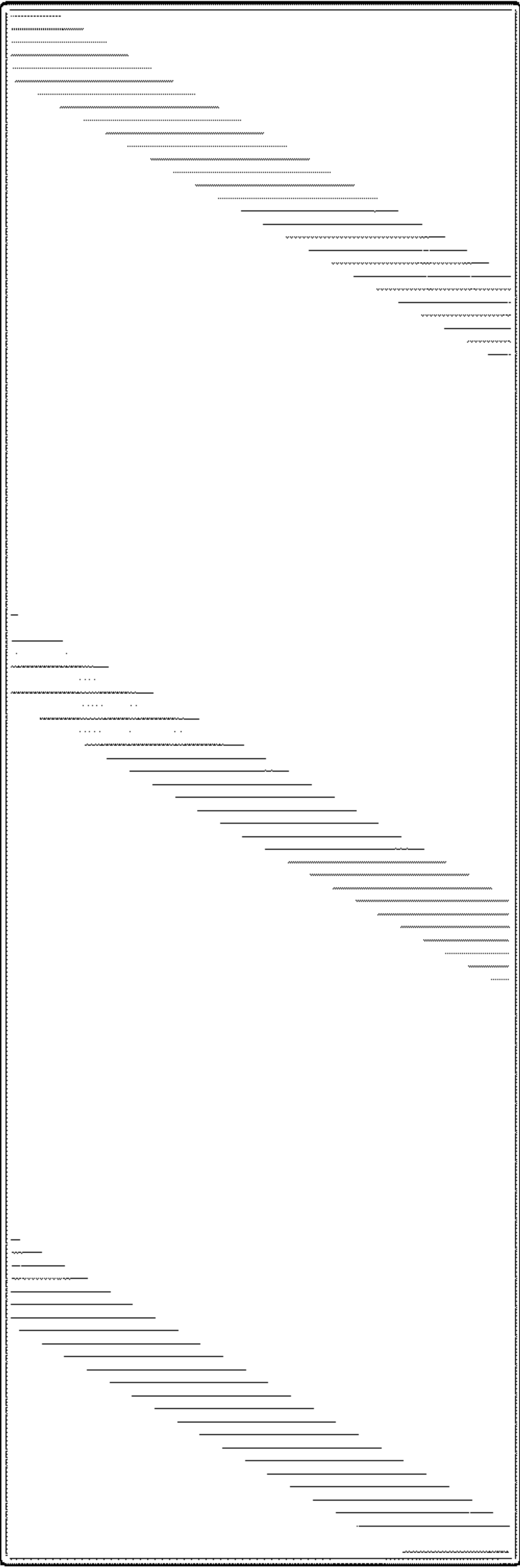

FIG. 6