



US00D717589S

(12) **United States Design Patent**
Harshman

(10) **Patent No.:** **US D717,589 S**

(45) **Date of Patent:** **** Nov. 18, 2014**

(54) **COMBINATION BOWL AND LID**

(71) Applicant: **Syndicate Sales Incorporated,**
Kokomo, IN (US)

(72) Inventor: **Trent A. Harshman,** Galveston, IN (US)

(73) Assignee: **Syndicate Sales Inc.,** Kokomo, IN (US)

(**) Term: **14 Years**

(21) Appl. No.: **29/448,333**

(22) Filed: **Mar. 12, 2013**

(51) **LOC (10) Cl.** **07-01**

(52) **U.S. Cl.**
USPC **D7/392.1**

(58) **Field of Classification Search**
CPC B65D 43/0222
USPC D9/503, 504, 394, 398, 544; D7/510,
D7/511, 629, 392.1, 392
See application file for complete search history.

(56) **References Cited**

U.S. PATENT DOCUMENTS

1,434,029	A	*	10/1922	Shover	239/55
D160,771	S	*	11/1950	Cowan	D7/392.1
D210,252	S	*	2/1968	Kemp	D9/503
D219,531	S	*	12/1970	Solomon	D7/391
D235,187	S	*	5/1975	Achenbach	D7/391
D243,307	S	*	2/1977	Loscalzo	D7/615
D249,439	S	*	9/1978	Benes et al.	D7/539
D266,135	S	*	9/1982	Husted	D7/540
D266,389	S	*	10/1982	Jensen et al.	D7/392.1
D270,697	S	*	9/1983	Thrush	D7/540
D292,159	S	*	10/1987	Thrush	D7/392.1
D329,962	S	*	10/1992	Hestehave et al.	D7/612

D418,102	S	*	12/1999	Schehr	D12/213
D420,251	S	*	2/2000	Brady	D7/392.1
D697,410	S	*	1/2014	Glasman	D9/503

OTHER PUBLICATIONS

“Apothecary Jars.” oldenimjeans.blogspot.com. Web. Jan. 21, 2011.*
“Classic Glass Apothecary Jars in the Kitchen.” athome.kimvallee.com. Web. Jan. 13, 2011.*
“Glass Apothecary Jars.” justpleasedaspunch.blogspot.com. Web. Aug. 23, 2010.*
“Glass Canisters with Glass Lids.” containerstore.com. Web. Feb. 18, 2010.*
“Home Value 50oz Glass Jar.” amazon.com. Web. Jun. 5, 2014.*
“Signature Housewares Sorrento Collection.” amazon.com. Web. Sep. 23, 2007.*
“Anchor Hocking Heritage Hill Glass Cookie/Candy Jar.” amazon.com. Web. Oct. 12, 2009.*

* cited by examiner

Primary Examiner — George D Kirschbaum

Assistant Examiner — Kendra L Hamilton

(74) *Attorney, Agent, or Firm* — Woodard, Emhardt, Moriarty, McNett & Henry LLP

(57) **CLAIM**

The ornamental design for a combination bowl and lid, as shown and described.

DESCRIPTION

FIG. 1 is a perspective view of the combination bowl and lid;
FIG. 2 is a reduced top view thereof;
FIG. 3 is a reduced bottom view thereof;
FIG. 4 is a reduced left side view thereof with the remaining sides being identical thereto; and,
FIG. 5 is a cross-sectional view taken along a line and viewed in the direction of arrows 5-5 of FIG. 4.

1 Claim, 3 Drawing Sheets

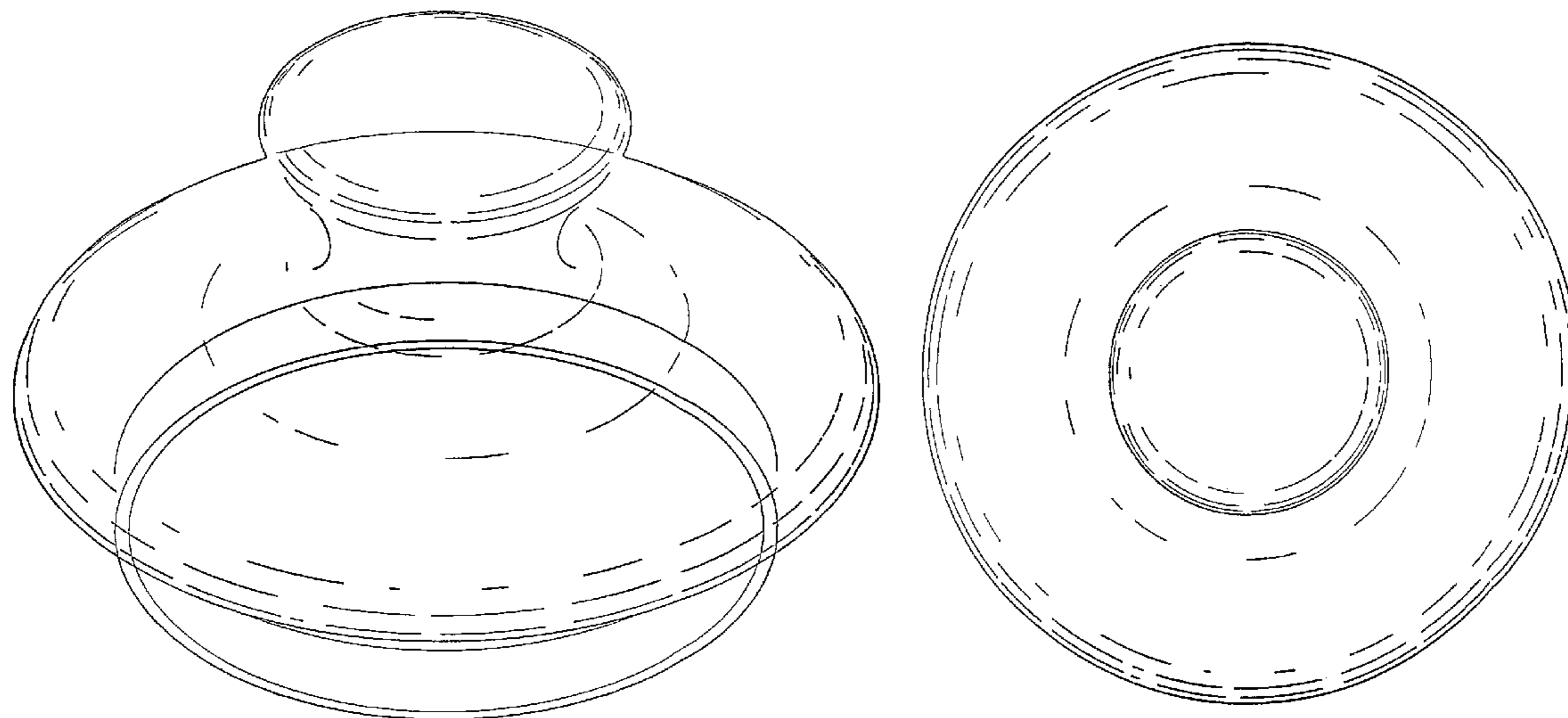

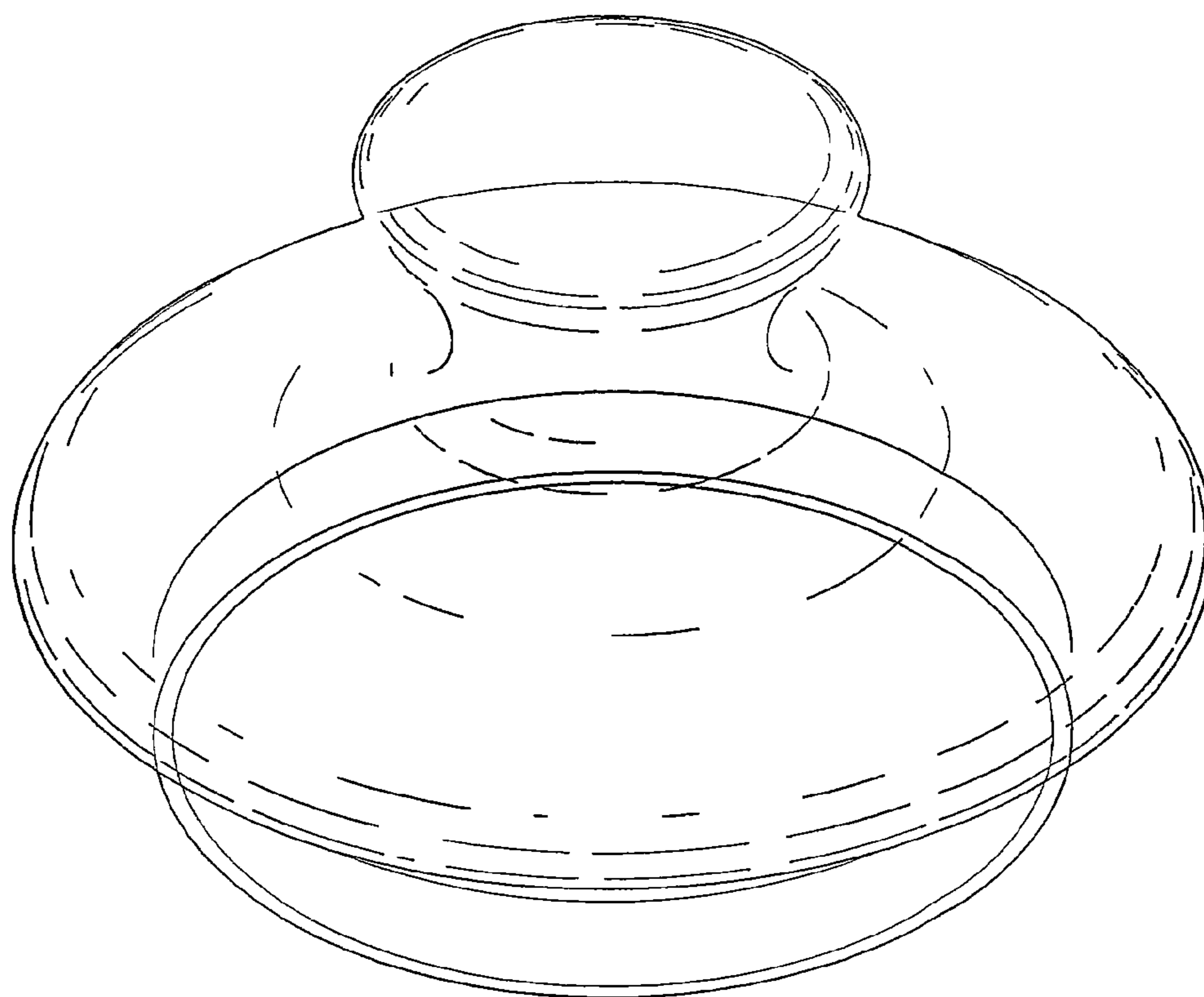

Fig. 1

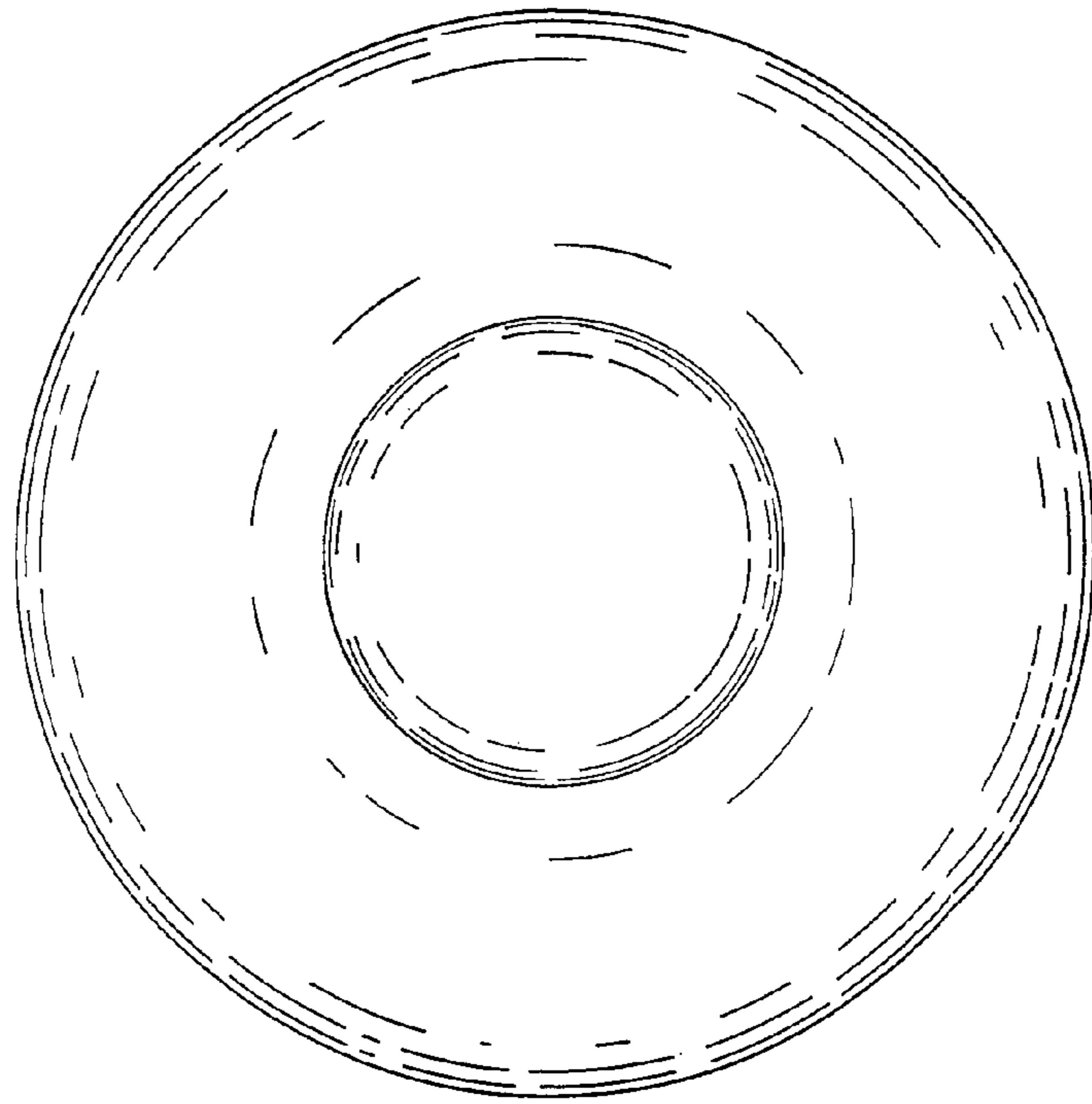

Fig. 2

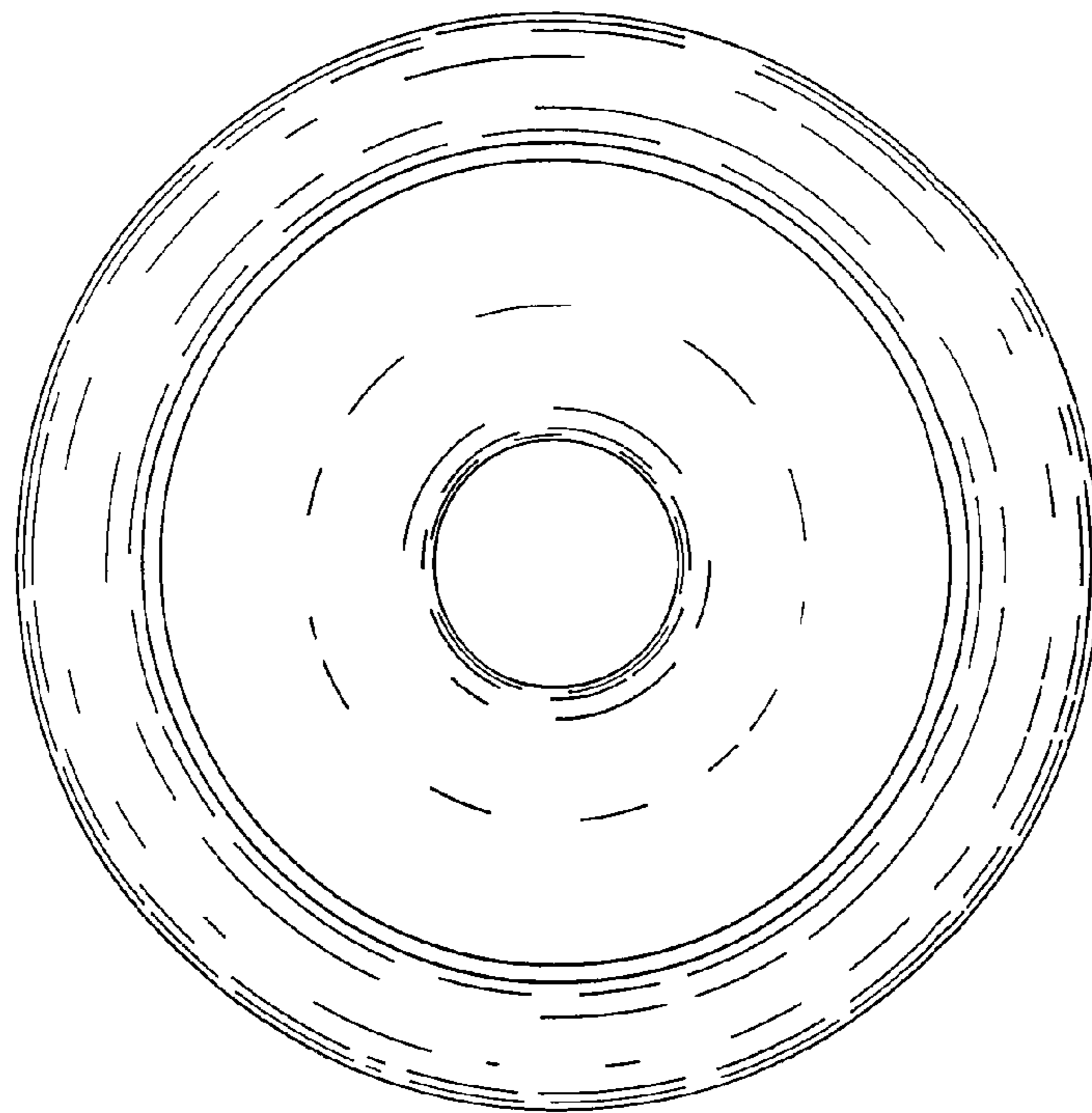

Fig. 3

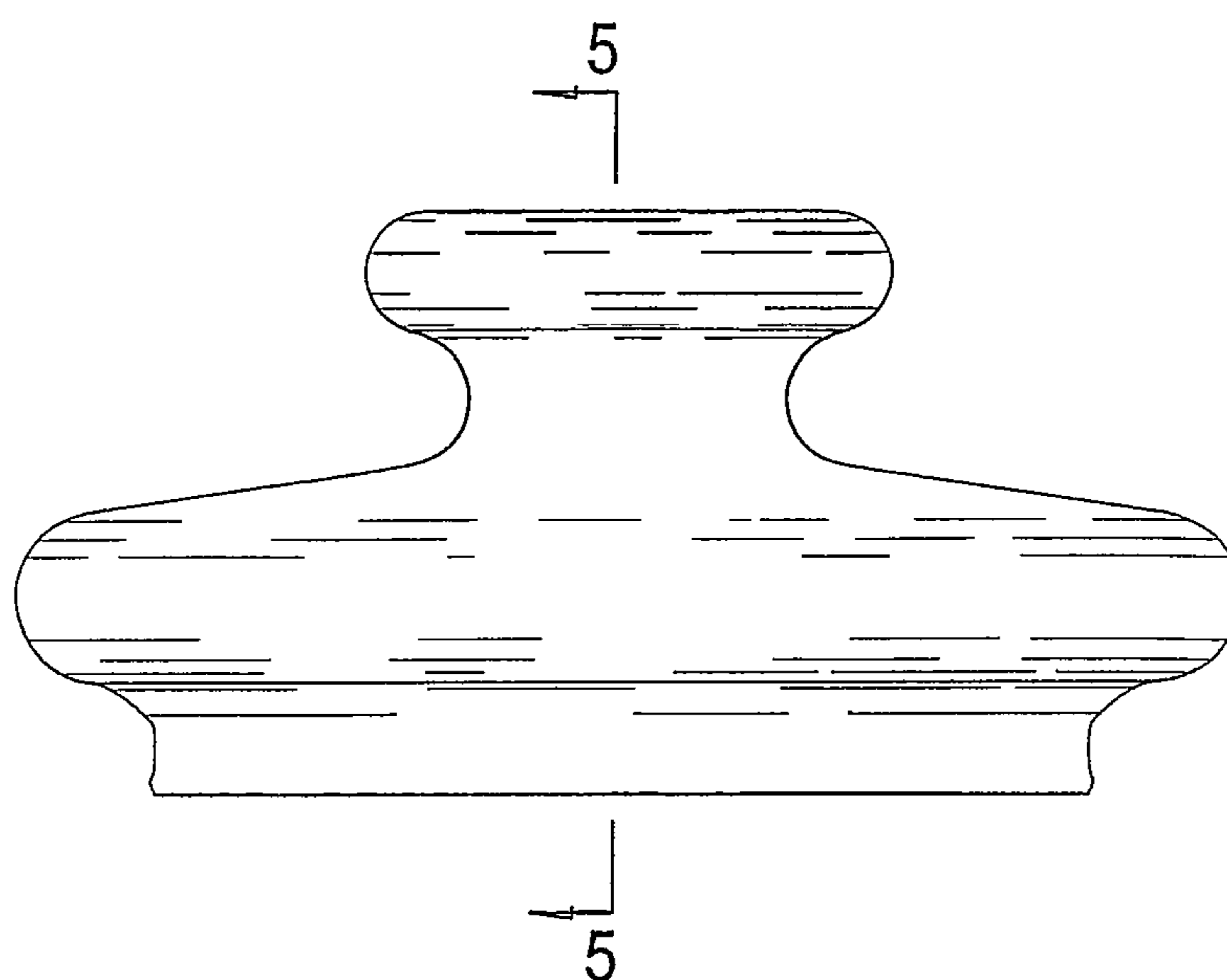

Fig. 4

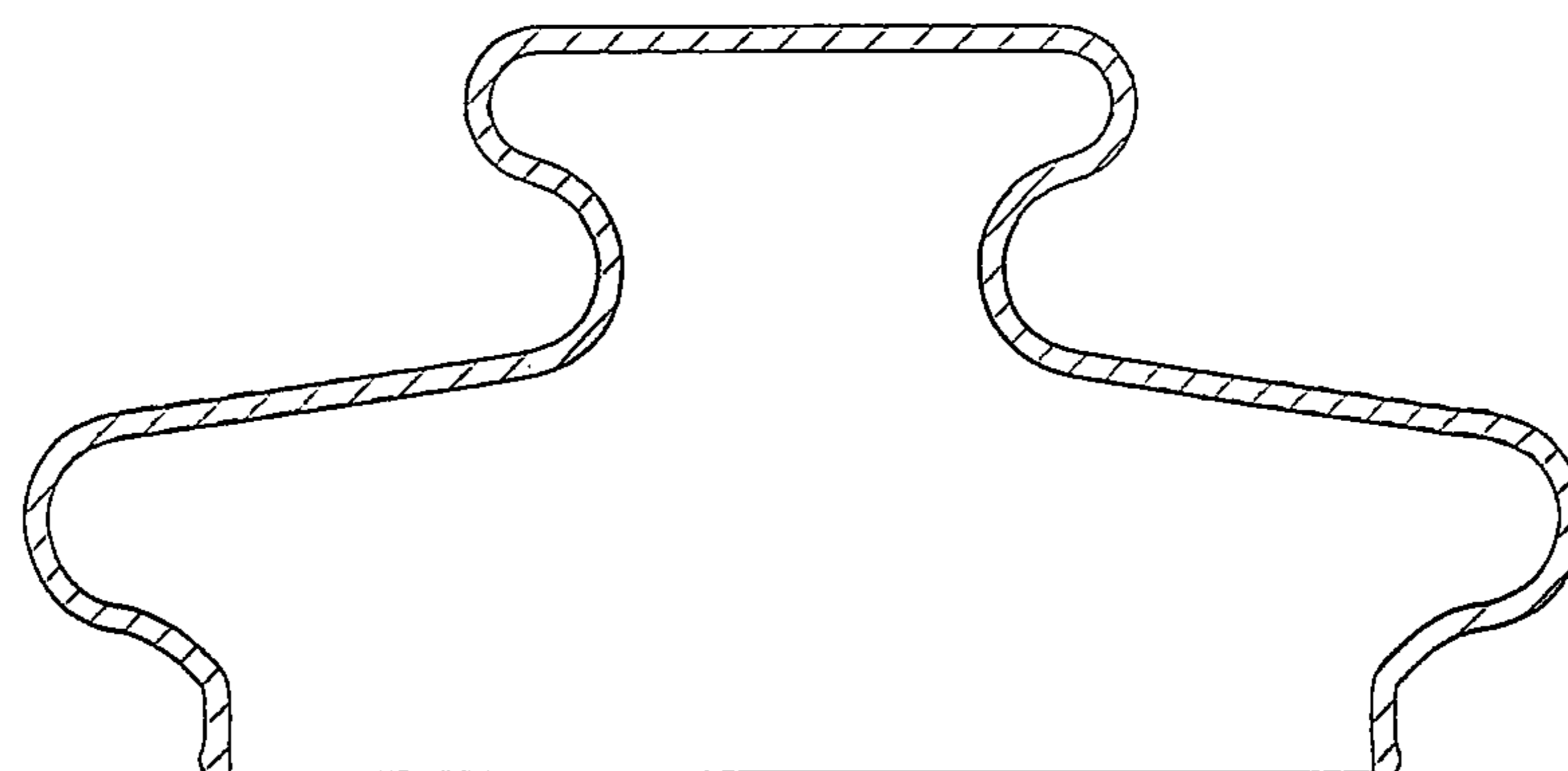

Fig. 5