



US00D717514S

(12) **United States Design Patent**  
**Miggels et al.**

(10) **Patent No.:** **US D717,514 S**

(45) **Date of Patent:** **\*\* Nov. 11, 2014**

(54) **LIFT TRUCK**

(75) Inventors: **Stephen G. Miggels**, Wyckoff, NJ (US);  
**Christopher M. Barrow**, Queens  
Village, NY (US); **Branden Francis**,  
Fort Meyers, FL (US)

(73) Assignee: **NMHG Oregon, LLC**, Portland, OR  
(US)

(\*\*) Term: **14 Years**

(21) Appl. No.: **29/426,141**

(22) Filed: **Jun. 29, 2012**

(51) **LOC (10) Cl.** ..... **12-05**

(52) **U.S. Cl.**  
USPC ..... **D34/34**

(58) **Field of Classification Search**  
USPC ..... D34/34, 35; 414/631, 575, 592;  
187/222, 234, 226, 238; 180/89.12,  
180/89.13, 89.17

See application file for complete search history.

(56) **References Cited**

**U.S. PATENT DOCUMENTS**

D405,150 S \* 2/1999 Magaline ..... D22/126  
6,137,398 A \* 10/2000 Dunlap et al. .... 340/439  
6,182,778 B1 \* 2/2001 Henshaw et al. .... 180/89.12

6,182,797 B1 \* 2/2001 Tebbe et al. .... 187/227  
D440,855 S \* 4/2001 Wang ..... D8/97  
6,236,927 B1 \* 5/2001 Sherman ..... 701/70  
D471,339 S \* 3/2003 Mori ..... D34/34  
D529,621 S \* 10/2006 Roberts ..... D24/229  
D585,623 S \* 1/2009 Quinlan et al. .... D34/34  
D605,374 S \* 12/2009 Nishikawa et al. .... D34/34  
D684,333 S \* 6/2013 Knie ..... D34/34

\* cited by examiner

*Primary Examiner* — Cynthia Ramirez

(57) **CLAIM**

We claim the ornamental design for a lift truck, as shown and described.

**DESCRIPTION**

FIG. 1 is a front isometric view of a lift truck in a first configuration;  
FIG. 2 is a front view of the lift truck of FIG. 1;  
FIG. 3 is a back view of the lift truck of FIG. 1;  
FIG. 4 is a left view of the lift truck of FIG. 1;  
FIG. 5 is a right view of the lift truck of FIG. 1;  
FIG. 6 is a top view of the lift truck of FIG. 1;  
FIG. 7 is a bottom view of the lift truck of FIG. 1; and,  
FIG. 8 is a front isometric view of the lift truck of FIG. 1 showing additional environmental components.  
In FIGS. 1-6, and 8 the broken lines indicate environmental features and form no part of the claimed design.

**1 Claim, 8 Drawing Sheets**

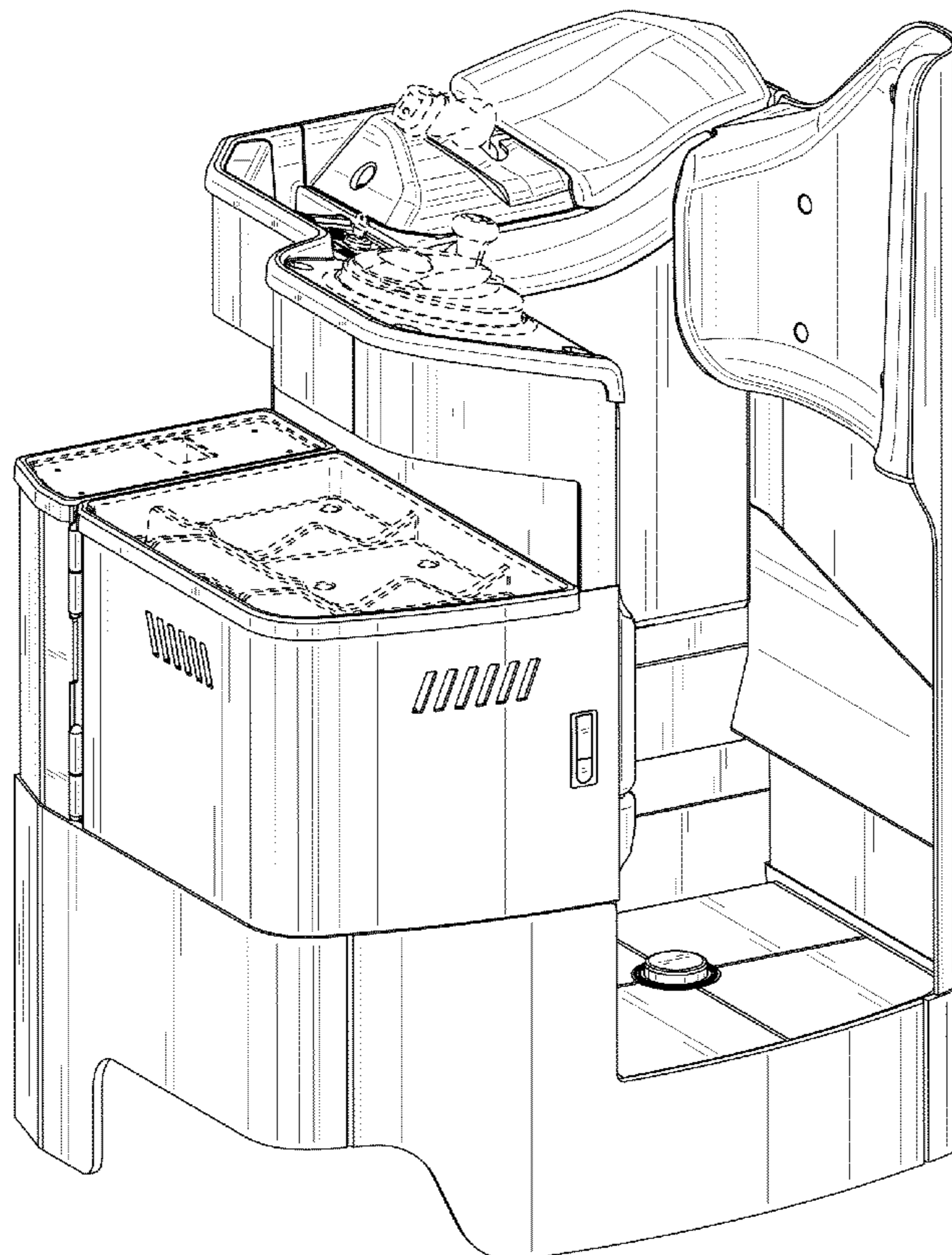

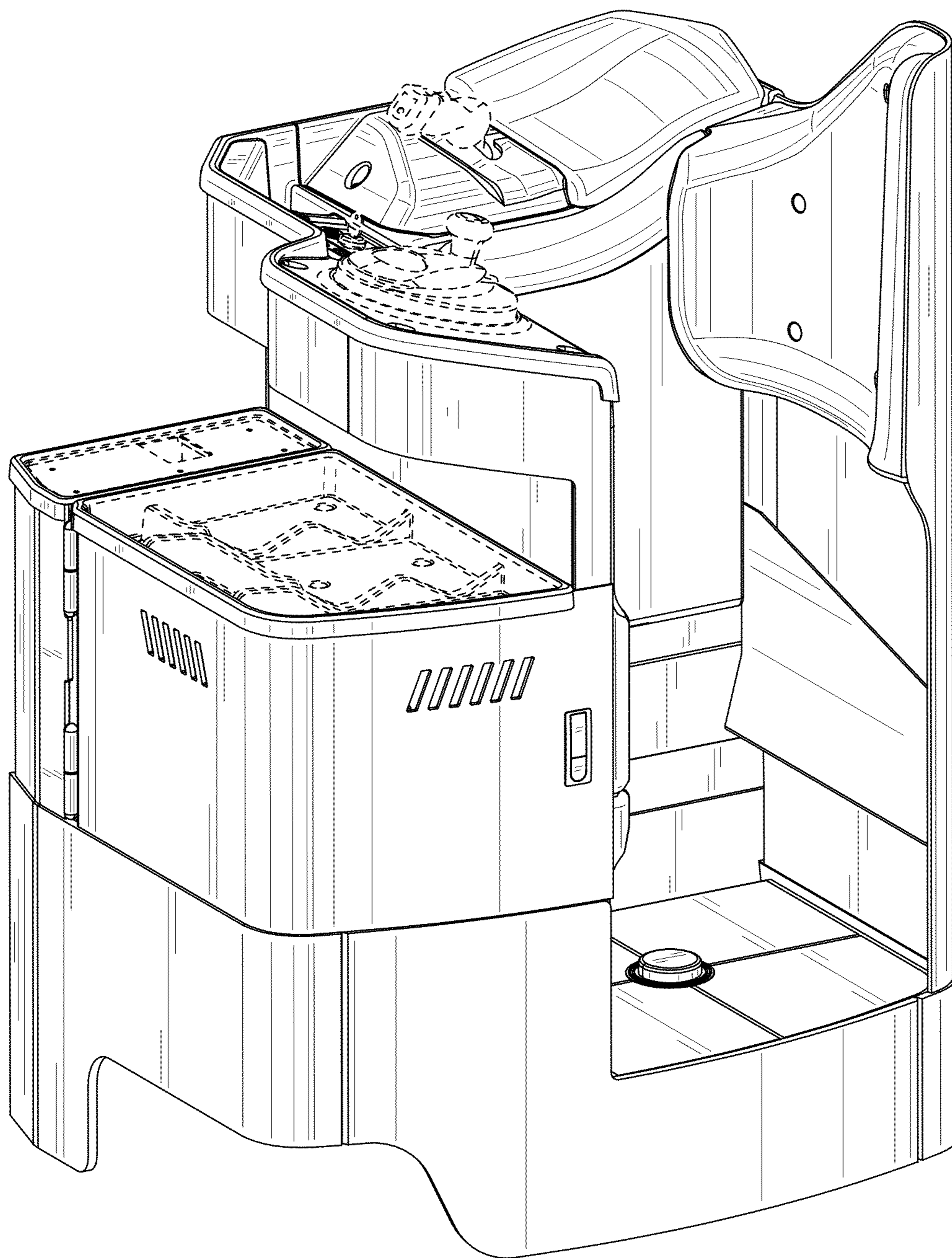

FIG. 1



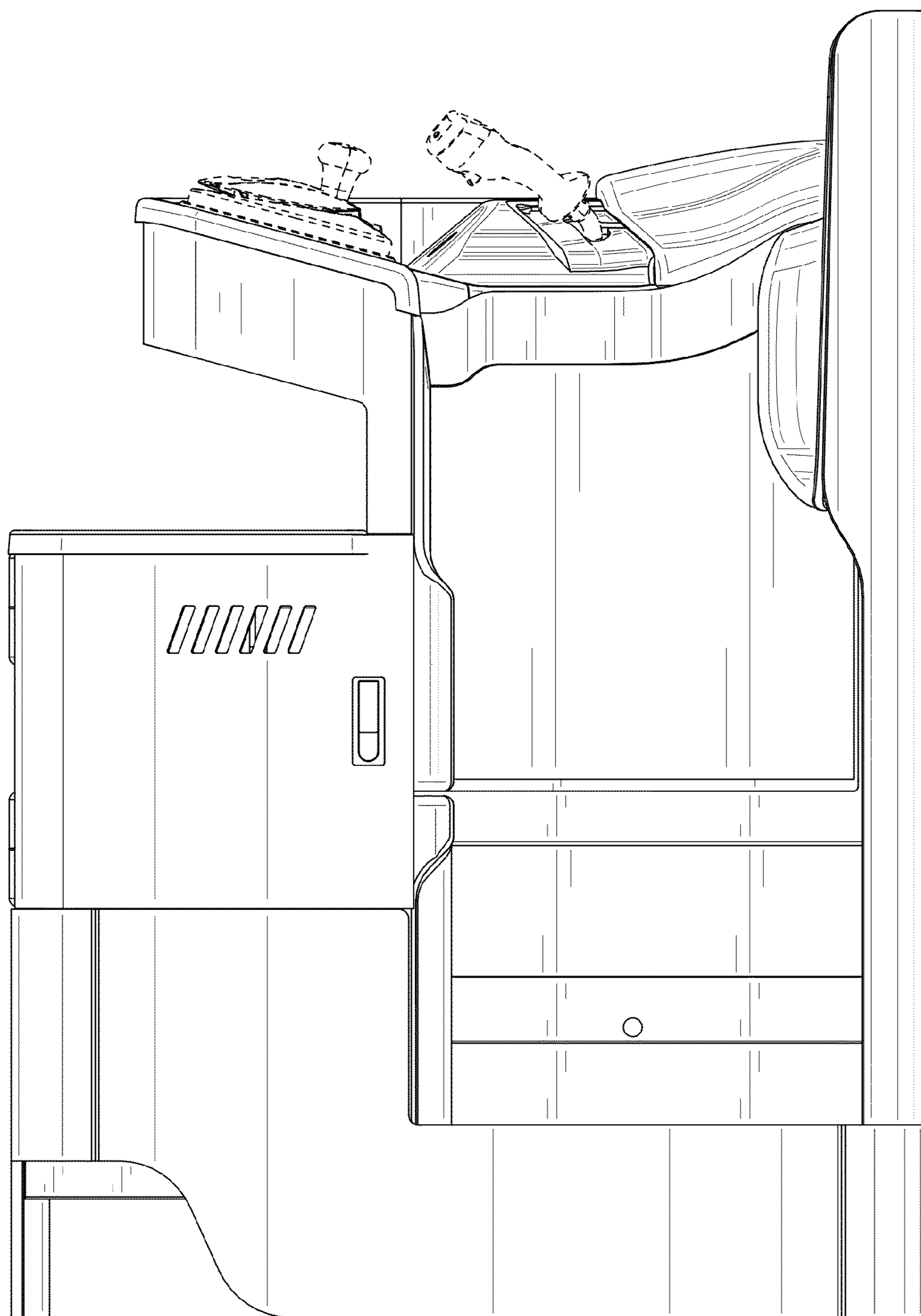

FIG. 2

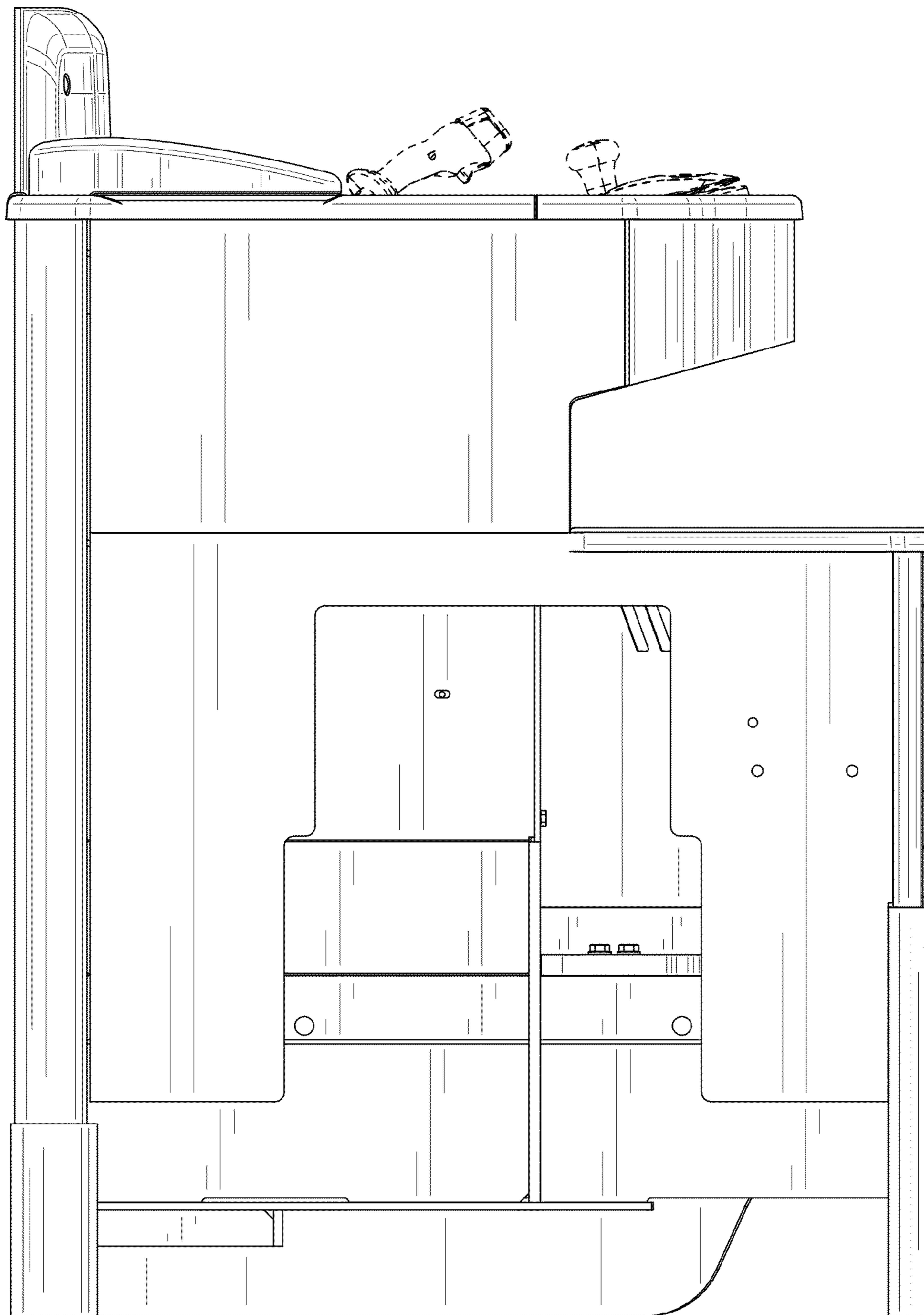

FIG. 3

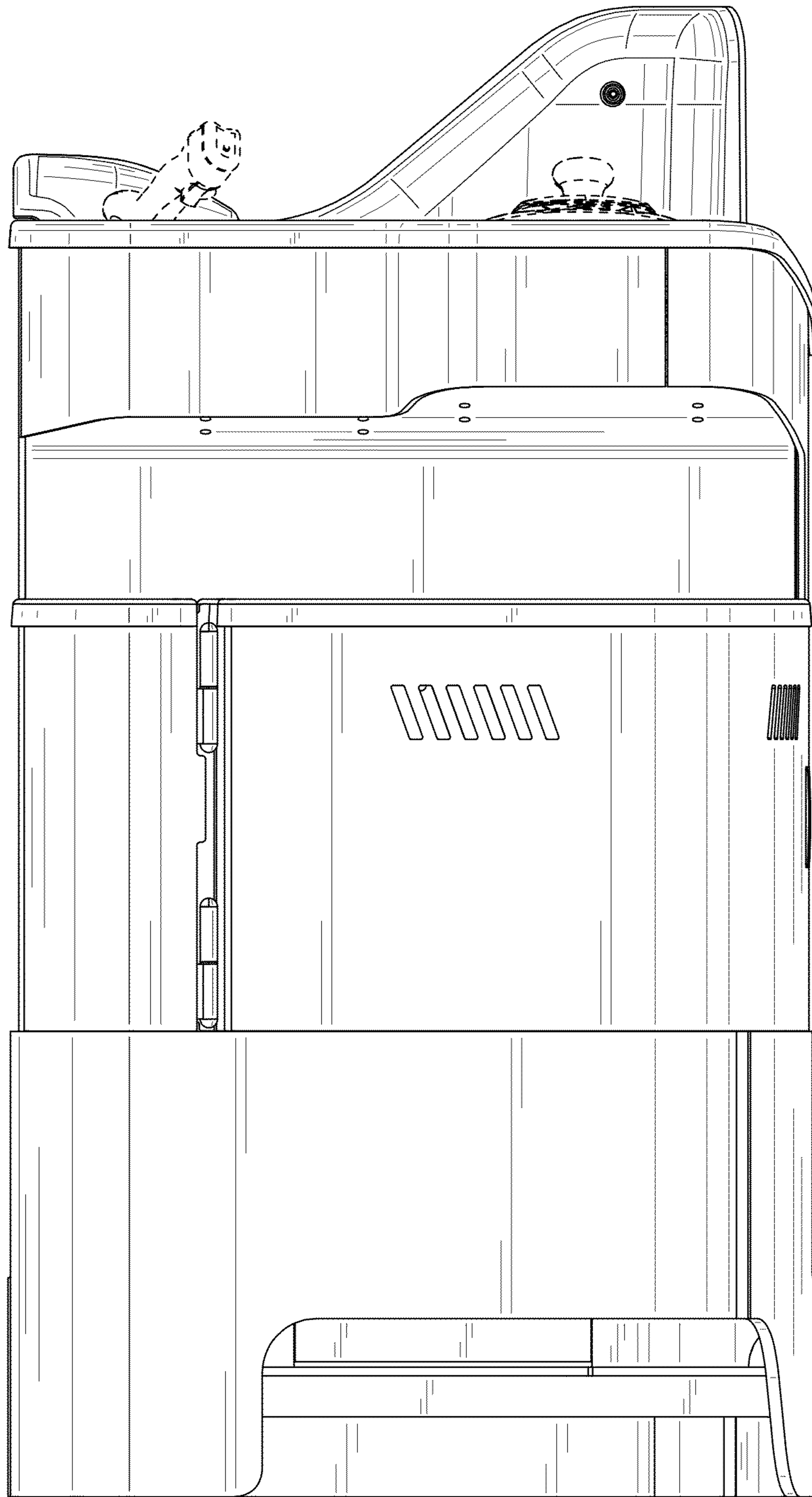

FIG. 4

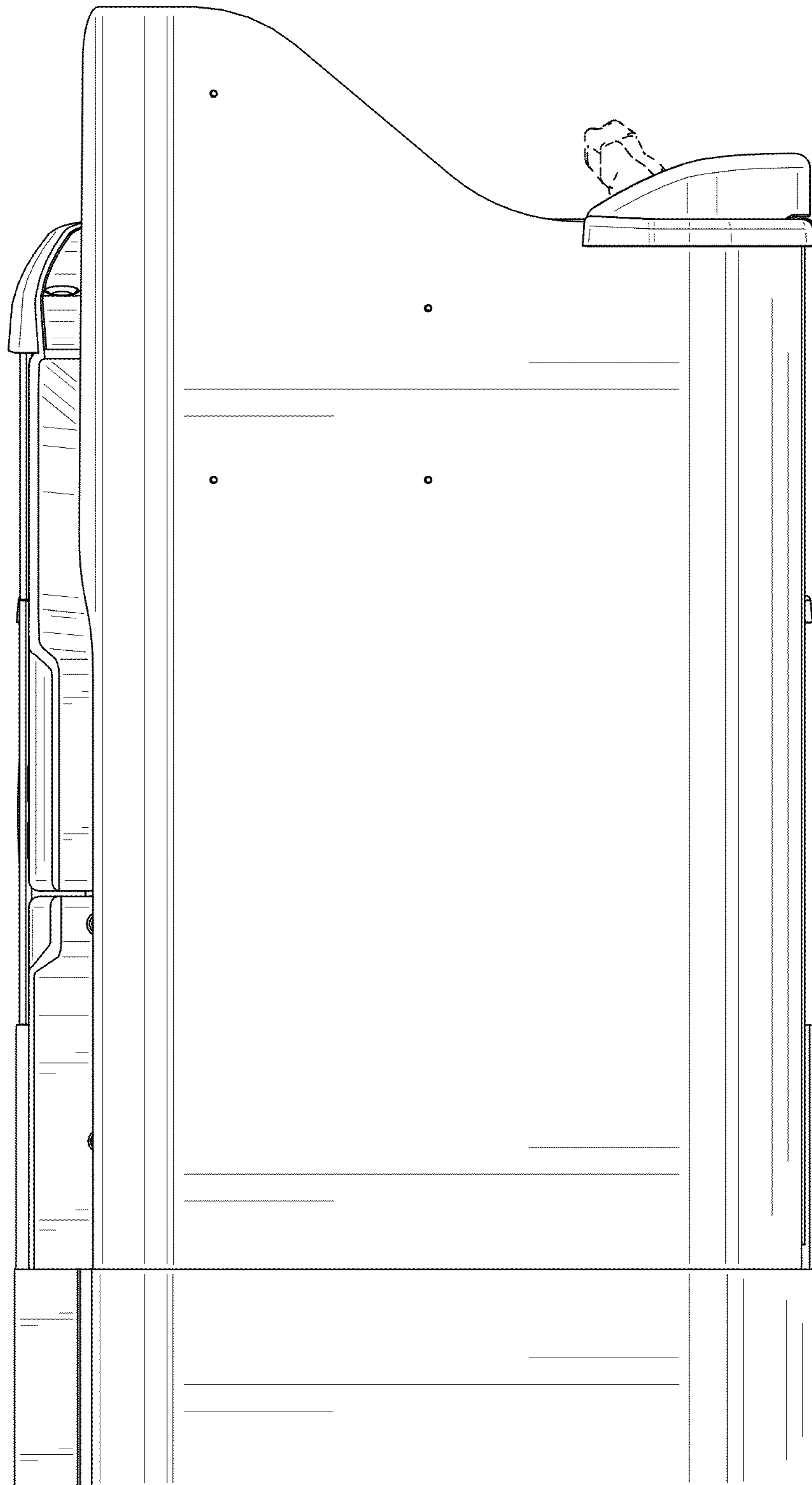

FIG. 5



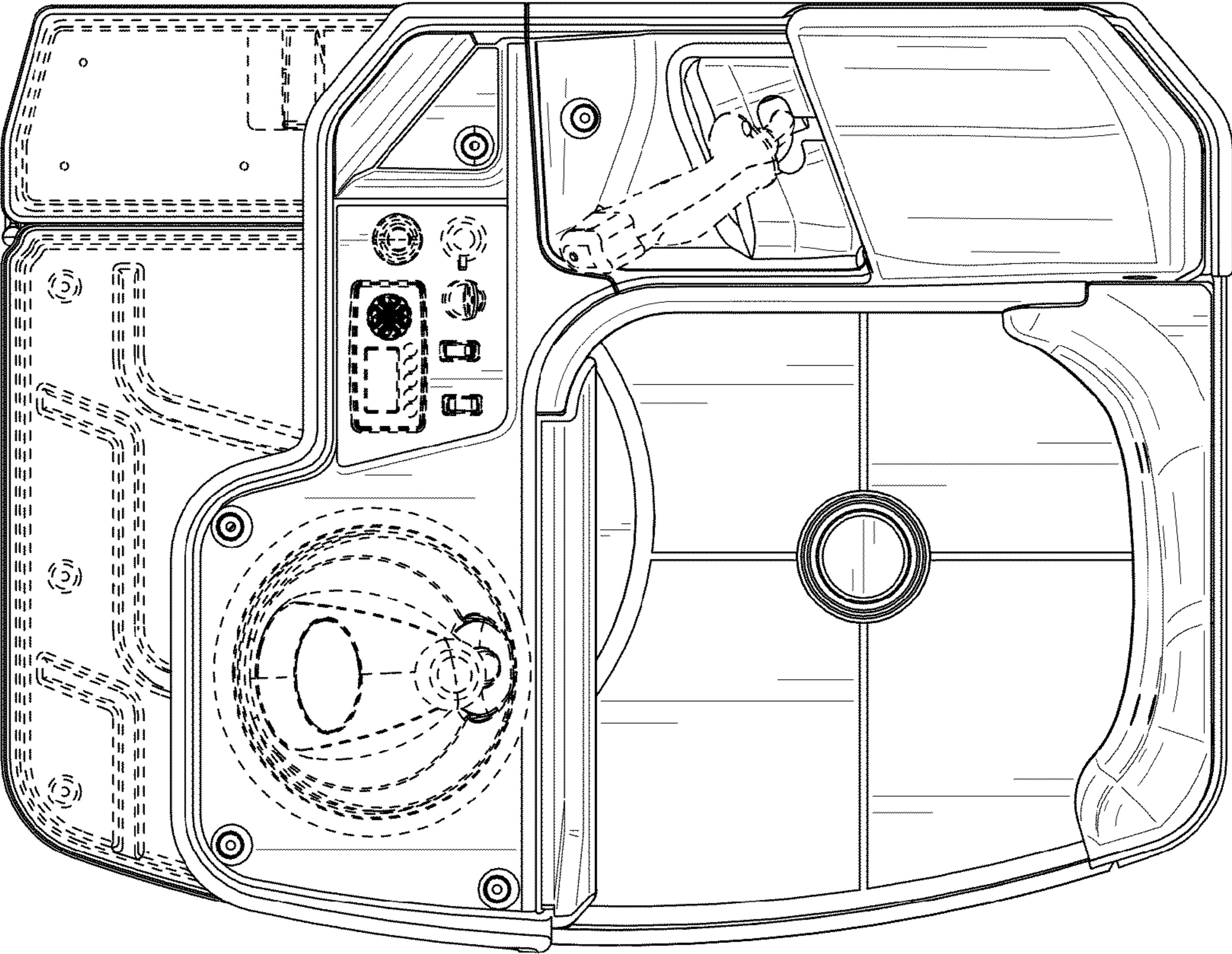

FIG. 6

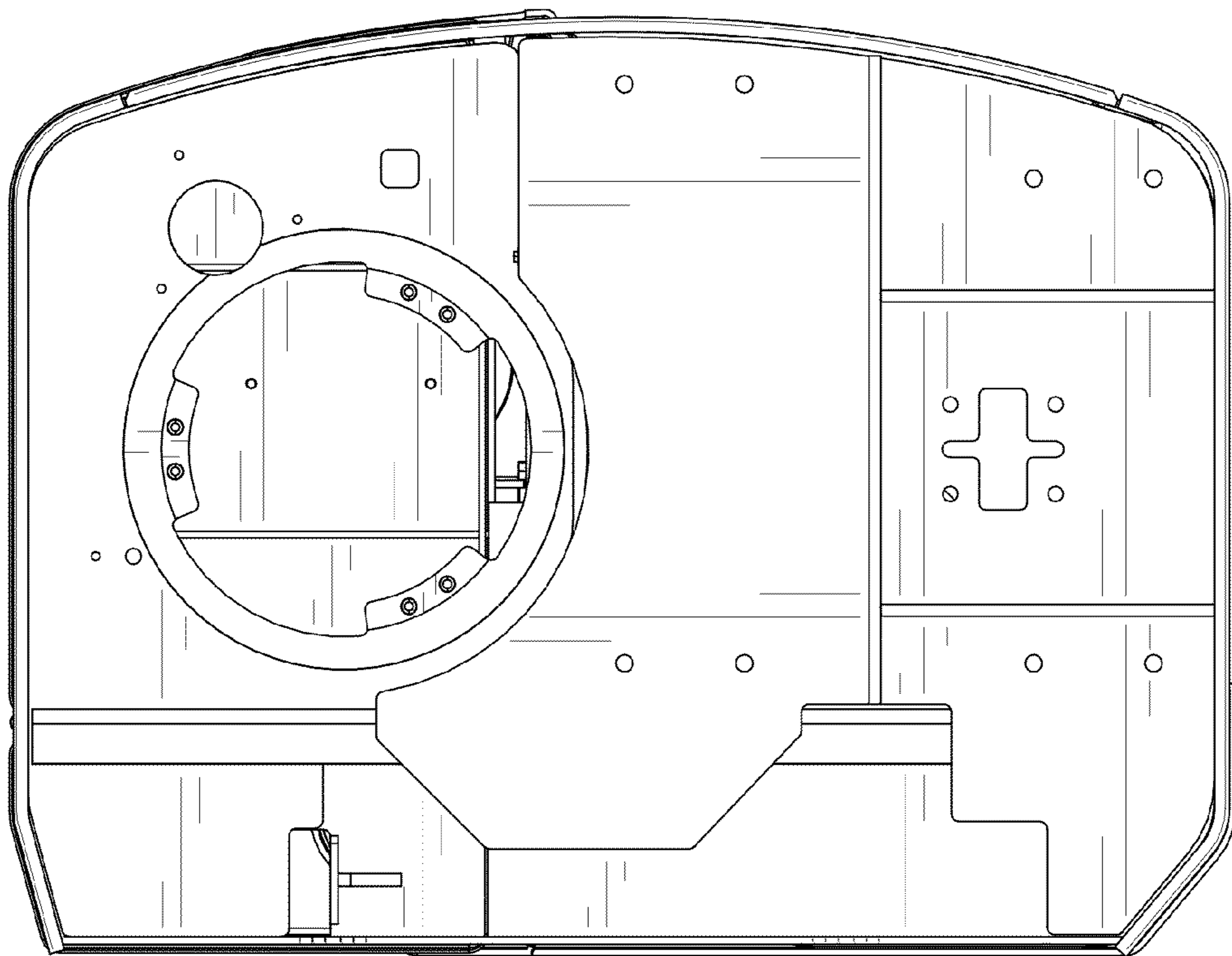

FIG. 7



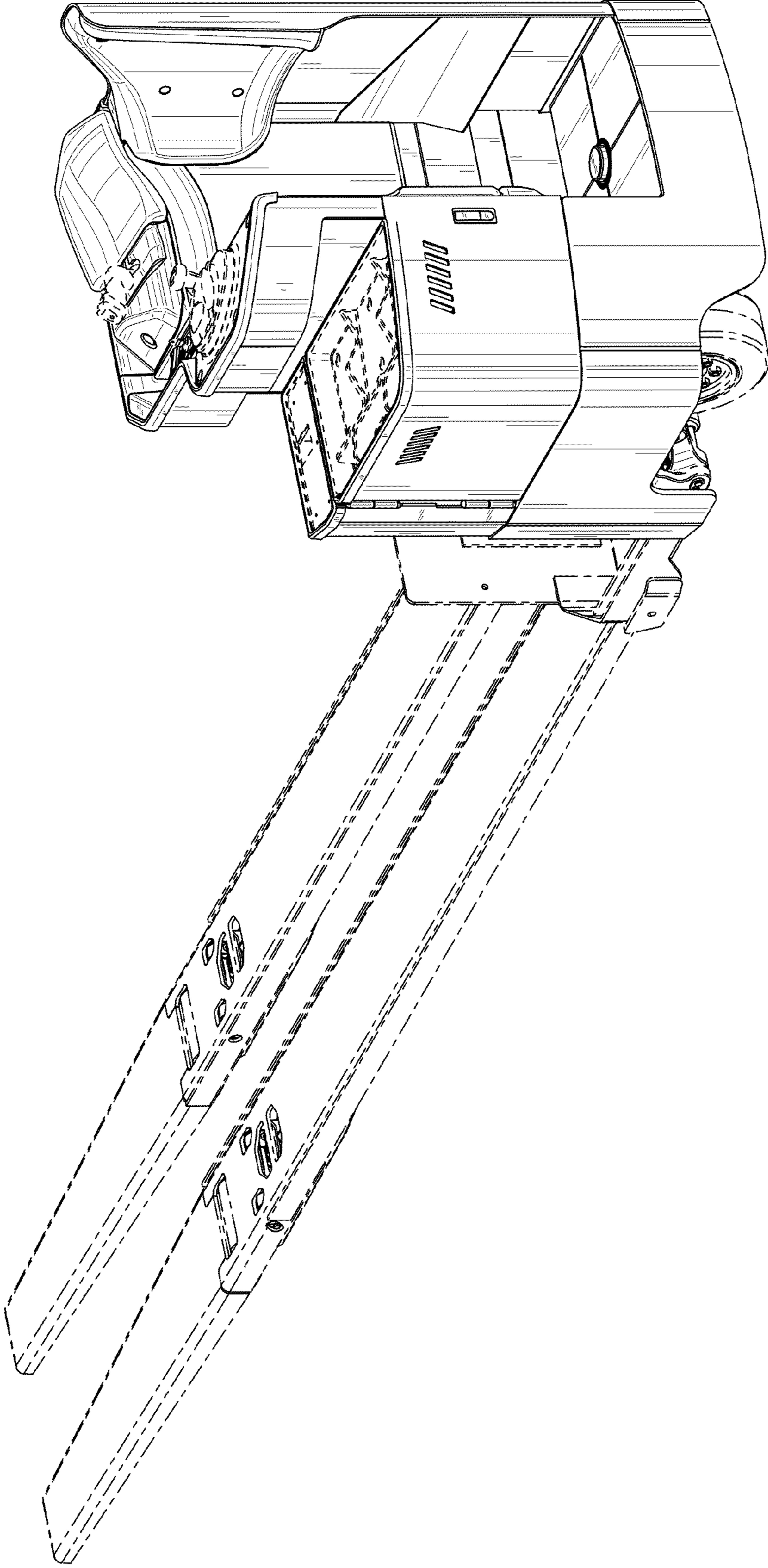

FIG. 8