



US00D717494S

(12) **United States Design Patent**  
**Stowers et al.**

(10) **Patent No.:** **US D717,494 S**

(45) **Date of Patent:** **\*\* Nov. 11, 2014**

(54) **SHAVING DEVICE**

(71) Applicants: **David Stowers**, Morristown, NJ (US);  
**Anand Khubani**, Towaco, NJ (US)

(72) Inventors: **David Stowers**, Morristown, NJ (US);  
**Anand Khubani**, Towaco, NJ (US)

(73) Assignee: **Idea Village Products Corp.**, Wayne, NJ  
(US)

(\*\*) Term: **14 Years**

(21) Appl. No.: **29/463,046**

(22) Filed: **Jul. 12, 2013**

(51) **LOC (10) Cl.** ..... **28-03**

(52) **U.S. Cl.**  
USPC ..... **D28/54**

(58) **Field of Classification Search**  
USPC ..... D28/49-54, 44-48; 30/34.05, 32, 34.1,  
30/34.2, 43-43.92, 29.5, 526-527, 44-45,  
30/341, 195-22, 272.1, 226-227, 231,  
30/233-233.5, 537

See application file for complete search history.

(56) **References Cited**

U.S. PATENT DOCUMENTS

D514,258	S	*	1/2006	Khubani et al.	.....	D28/53
D516,245	S	*	2/2006	Ohta et al.	.....	D28/49
D561,941	S	*	2/2008	Khubani	.....	D28/53
D569,552	S	*	5/2008	Marquez	.....	D28/53
D620,644	S	*	7/2010	Lau et al.	.....	D28/54
2007/0028447	A1	*	2/2007	Ogawa et al.	.....	30/29.5

\* cited by examiner

*Primary Examiner* — Jennifer Rivard

(74) *Attorney, Agent, or Firm* — Dan DeLaRosa

(57) **CLAIM**

The ornamental design for a shaving device, as shown and described.

**DESCRIPTION**

FIG. 1 is a front perspective view of the shaving device of the present invention showing my new design;  
FIG. 2 is a side elevational view thereof;  
FIG. 3 is another side elevational view thereof;  
FIG. 4 is a front side elevational view thereof;  
FIG. 5 is a back side elevational view thereof;  
FIG. 6 is a top plan view thereof; and,  
FIG. 7 is a bottom plan view thereof.  
The broken lines illustrate portions of the shaving device and form no part of the claimed design.

**1 Claim, 6 Drawing Sheets**

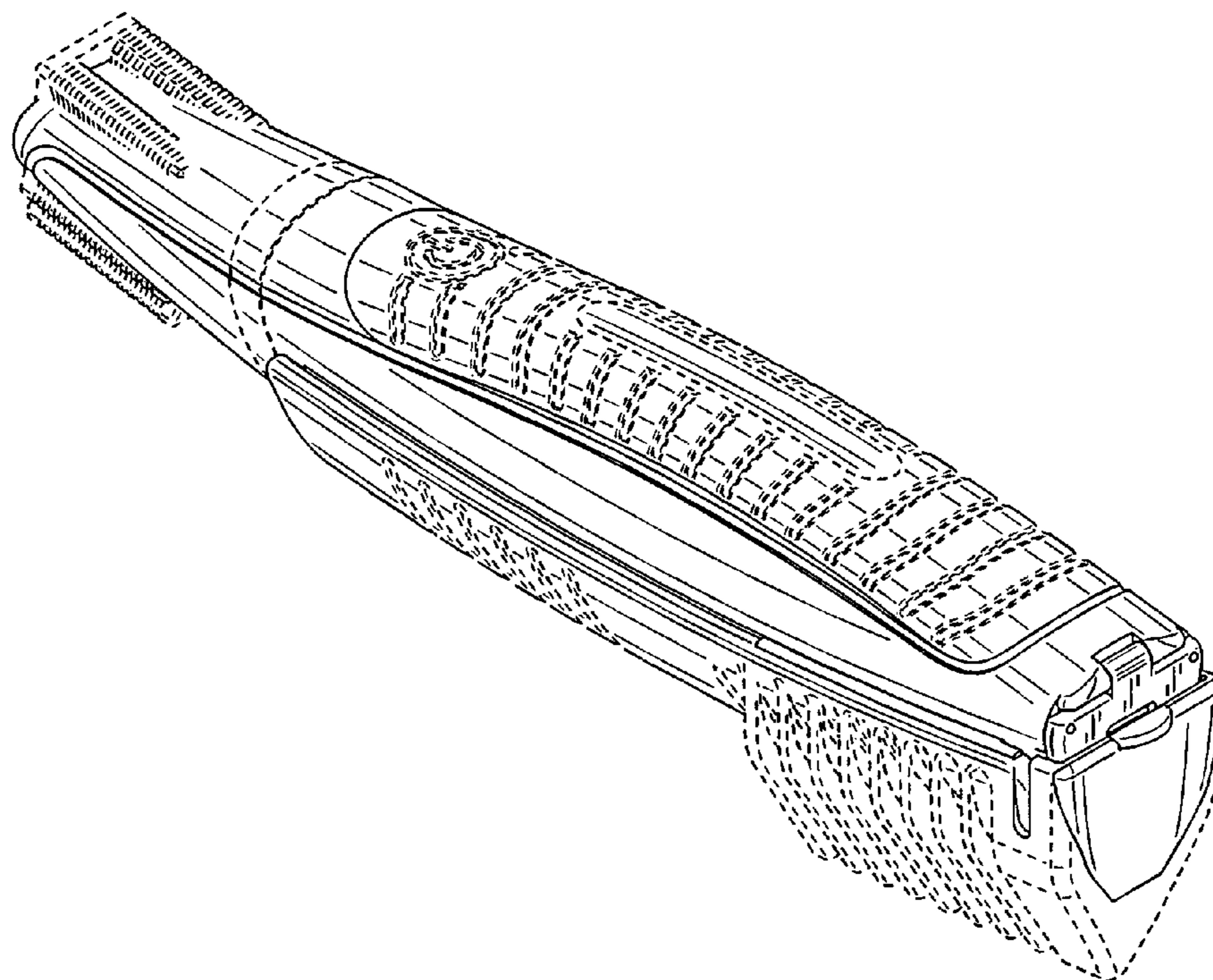

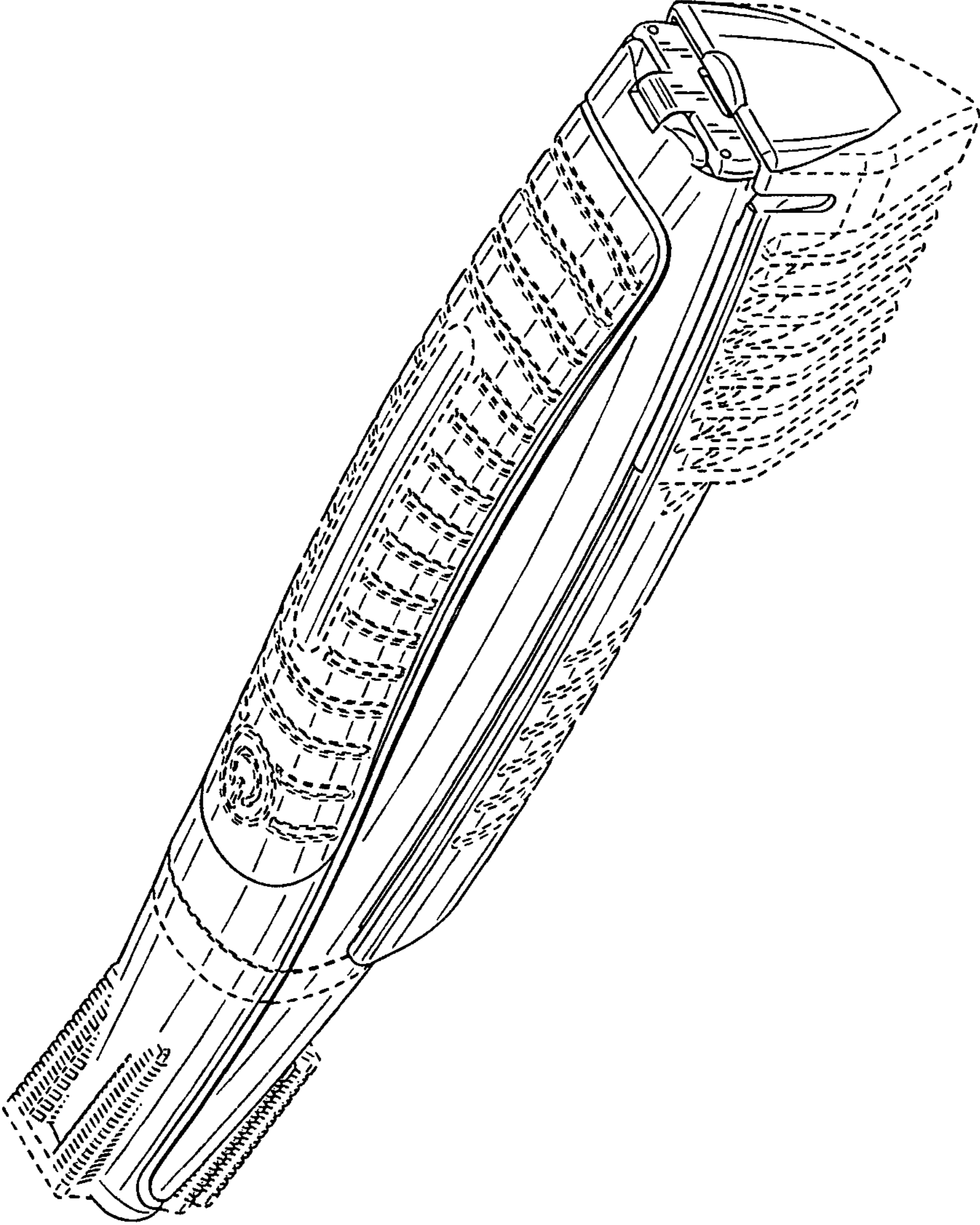

FIG. 1

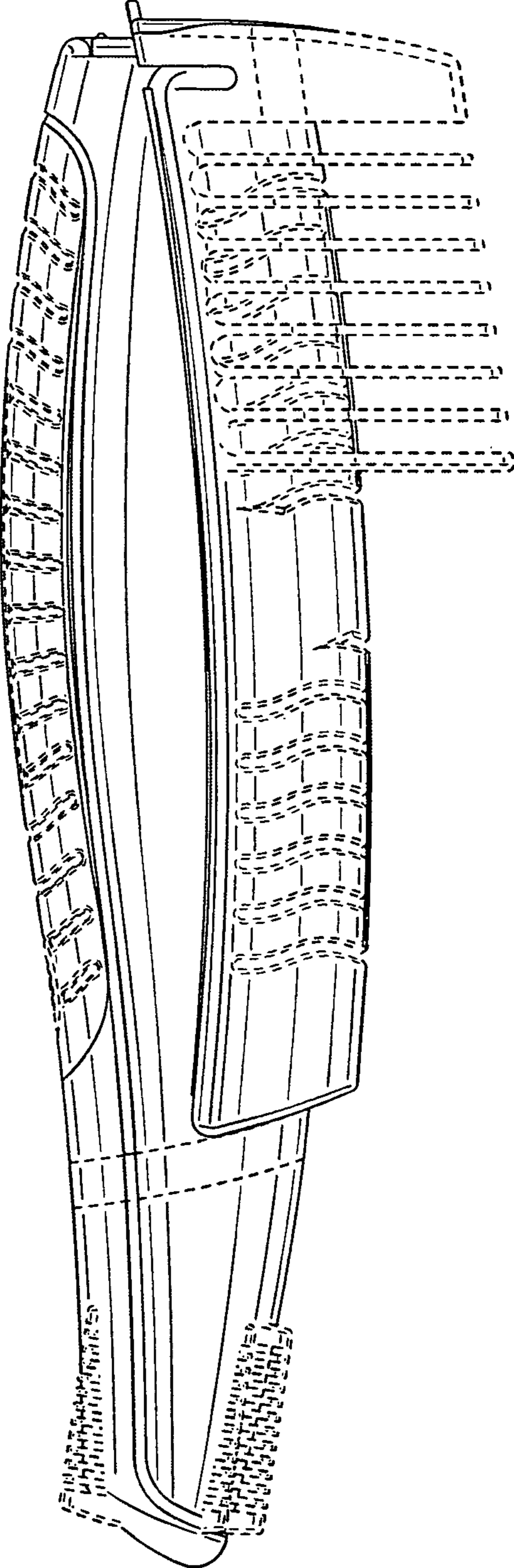

FIG. 2

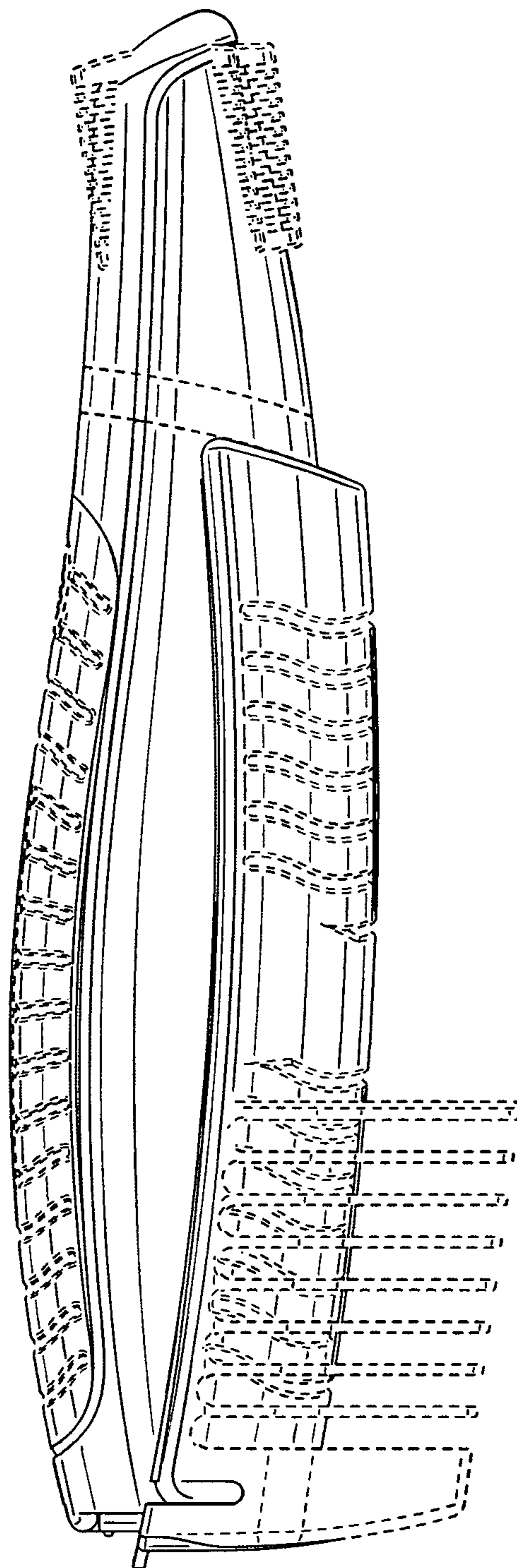

FIG. 3

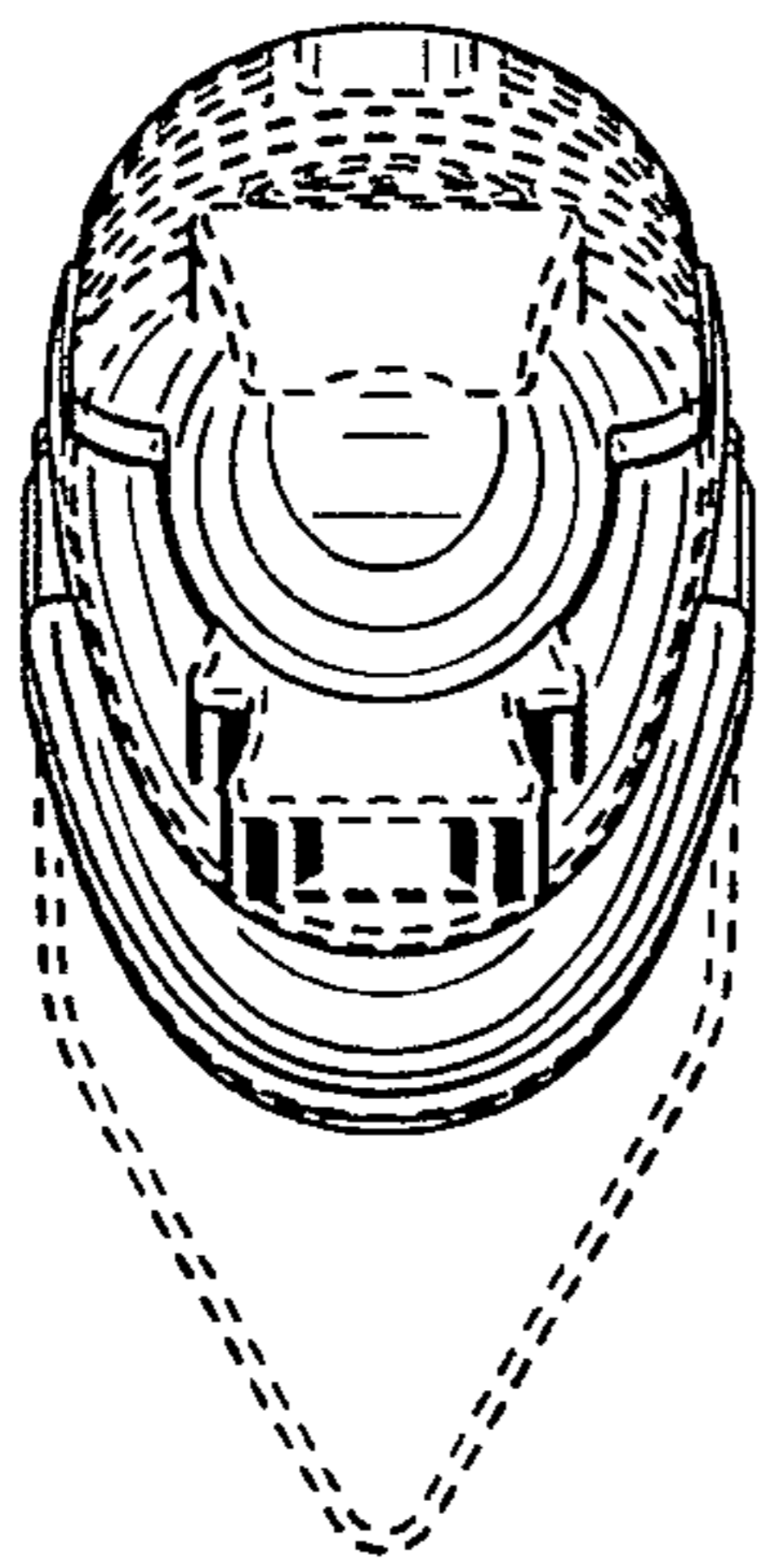

FIG. 4

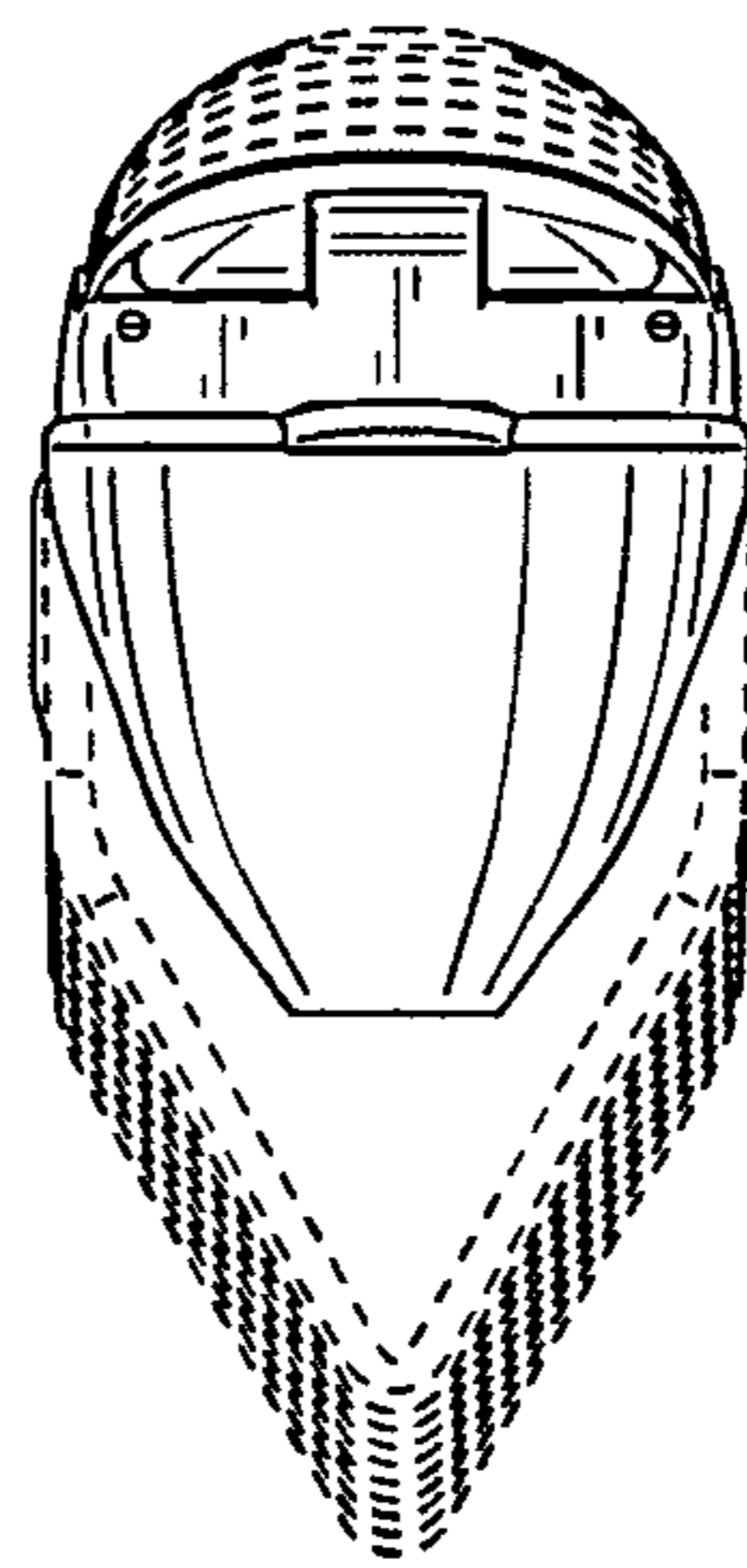

FIG. 5

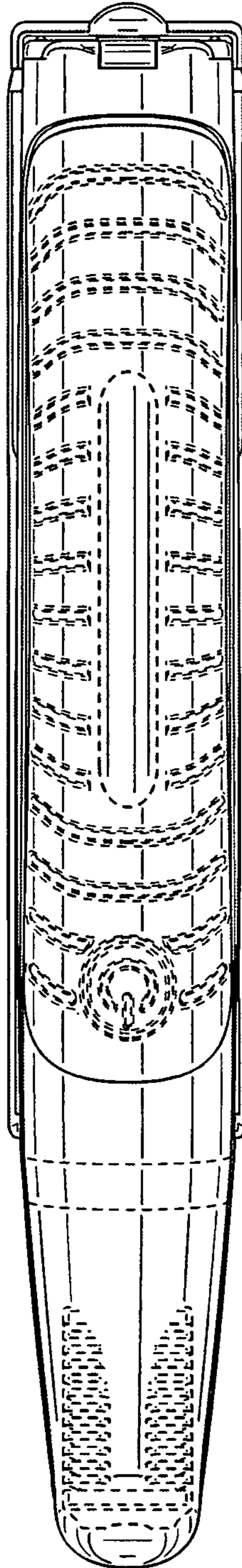

FIG. 6

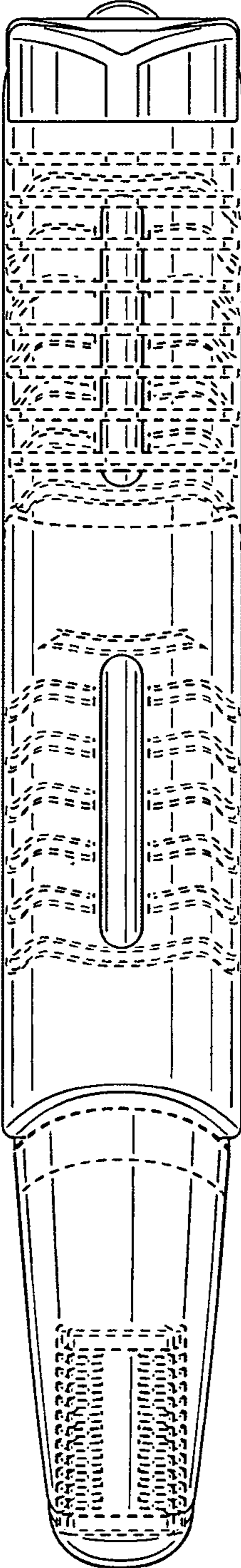

FIG. 7