



US00D717442S

(12) **United States Design Patent**
Kaib et al.

(10) **Patent No.:** **US D717,442 S**

(45) **Date of Patent:** **** Nov. 11, 2014**

(54) **DEFIBRILLATOR**

(71) Applicant: **ZOLL Medical Corporation**,
Chelmsford, MA (US)

(72) Inventors: **Thomas E. Kaib**, North Huntingdon, PA
(US); **Rachel H. Carlson**, Falls Creek,
PA (US)

(73) Assignee: **ZOLL Medical Corporation**,
Chelmsford, MA (US)

(**) Term: **14 Years**

(21) Appl. No.: **29/459,355**

(22) Filed: **Jun. 28, 2013**

(51) **LOC (10) Cl.** **24-01**

(52) **U.S. Cl.**
USPC **D24/167**

(58) **Field of Classification Search**
USPC D24/165-168, 186, 187; 607/5-8, 10,
607/36, 37

See application file for complete search history.

(56) **References Cited**

U.S. PATENT DOCUMENTS

D269,373 S * 6/1983 Belt et al. D24/167
D343,901 S * 2/1994 Anderson D24/167

D494,681 S * 8/2004 Mills et al. D24/167
D548,346 S * 8/2007 Vaisnys et al. D24/167
D597,211 S * 7/2009 Ewing et al. D24/187
D616,993 S * 6/2010 Muis et al. D24/186
D659,836 S * 5/2012 Bensch et al. D24/167
D676,134 S * 2/2013 Søvareid et al. D24/167
D690,818 S * 10/2013 Pastrick et al. D24/167
2010/0241181 A1 * 9/2010 Savage et al. 607/5

* cited by examiner

Primary Examiner — Anhdao Doan

(74) *Attorney, Agent, or Firm* — The Webb Law Firm

(57) **CLAIM**

The ornamental design for a defibrillator, as shown and described.

DESCRIPTION

FIG. 1 is a front perspective view of a defibrillator in accordance with the present invention;

FIG. 2 is a front side plan view thereof;

FIG. 3 is a rear side plan view thereof;

FIG. 4 is a right side plan view thereof;

FIG. 5 is a left side plan view thereof;

FIG. 6 is a top plan view thereof; and,

FIG. 7 is a bottom plan view thereof.

The broken lines illustrating portions of the defibrillator form no part of the claimed design.

1 Claim, 5 Drawing Sheets

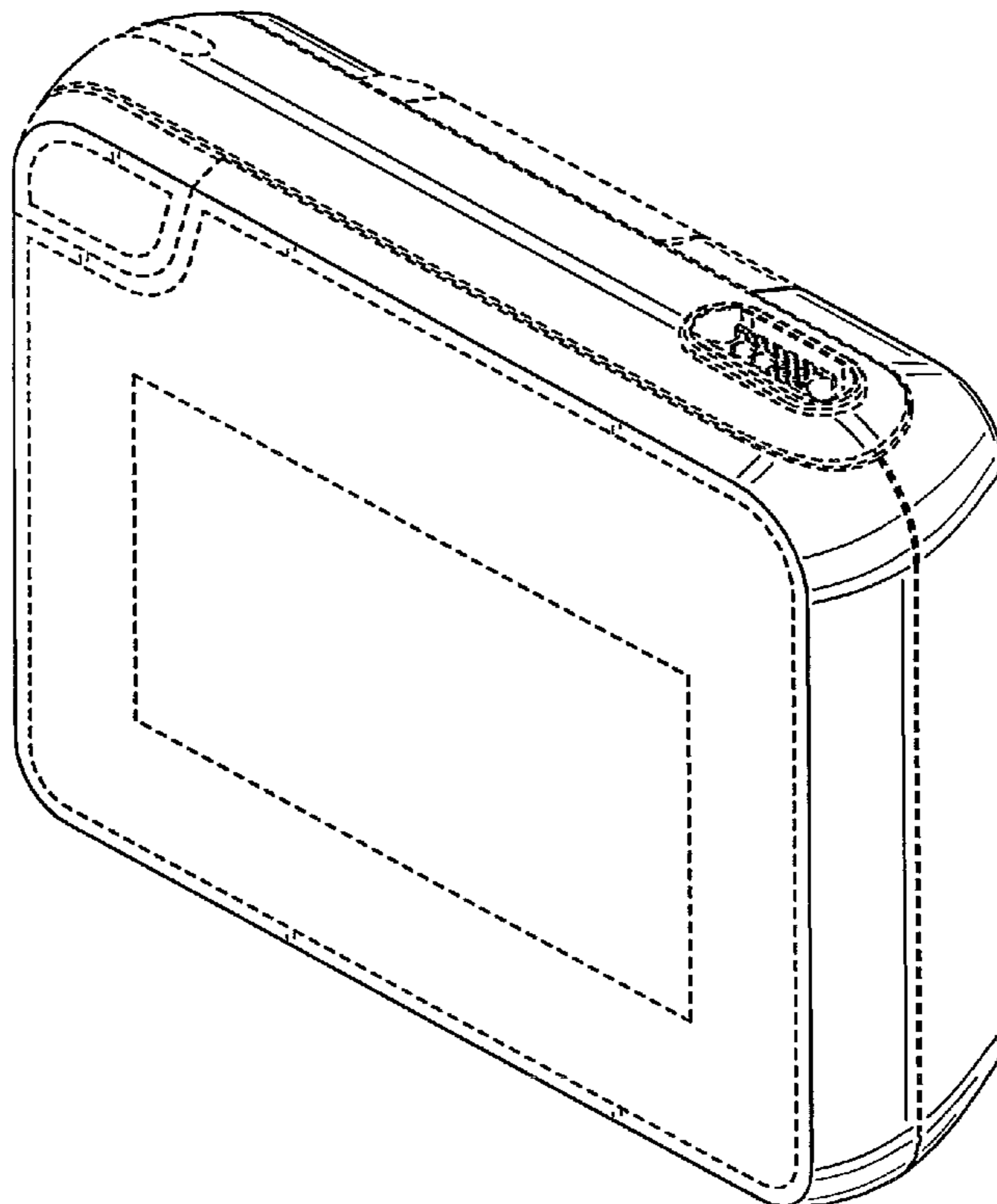



FIG. 1

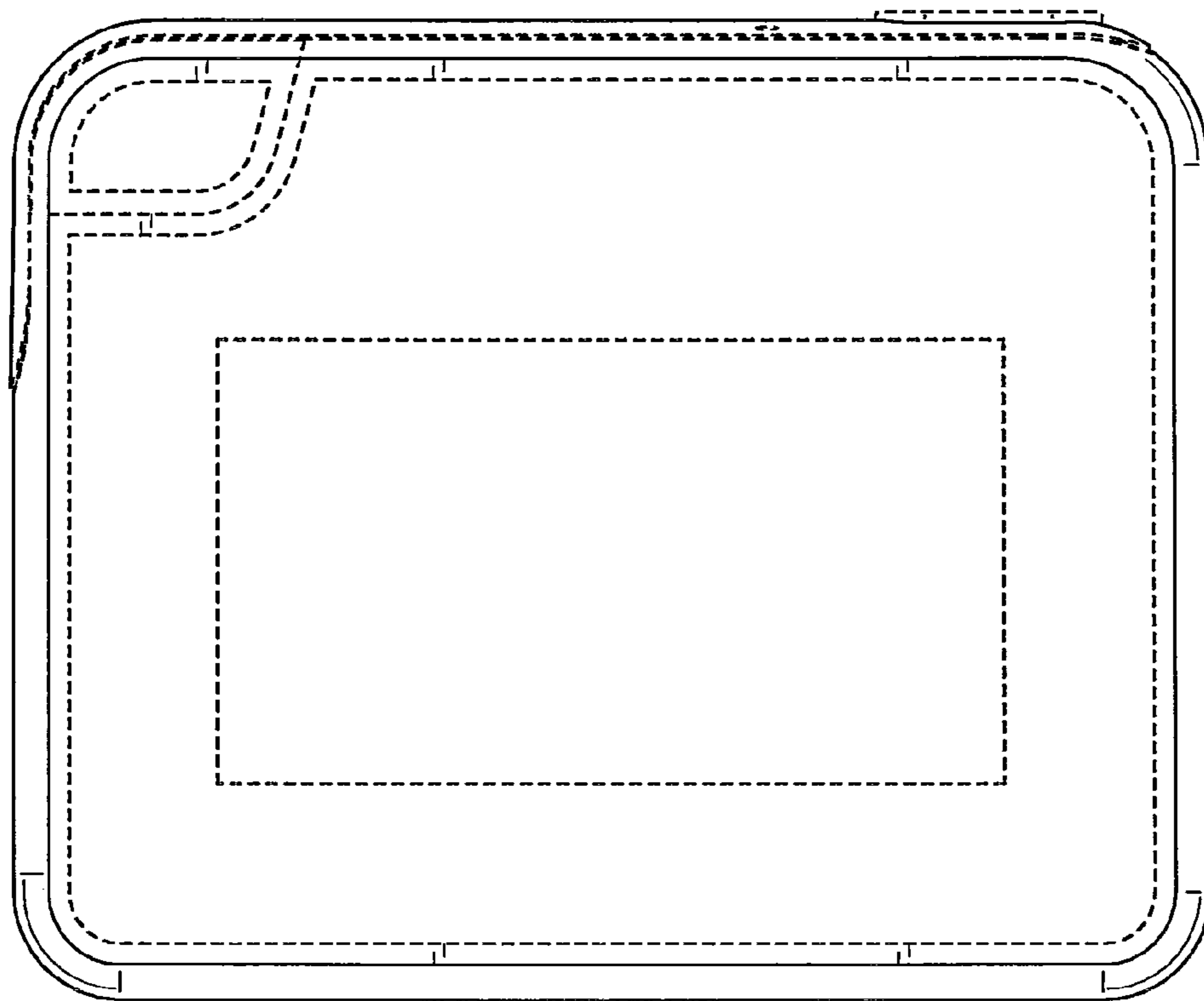

FIG. 2

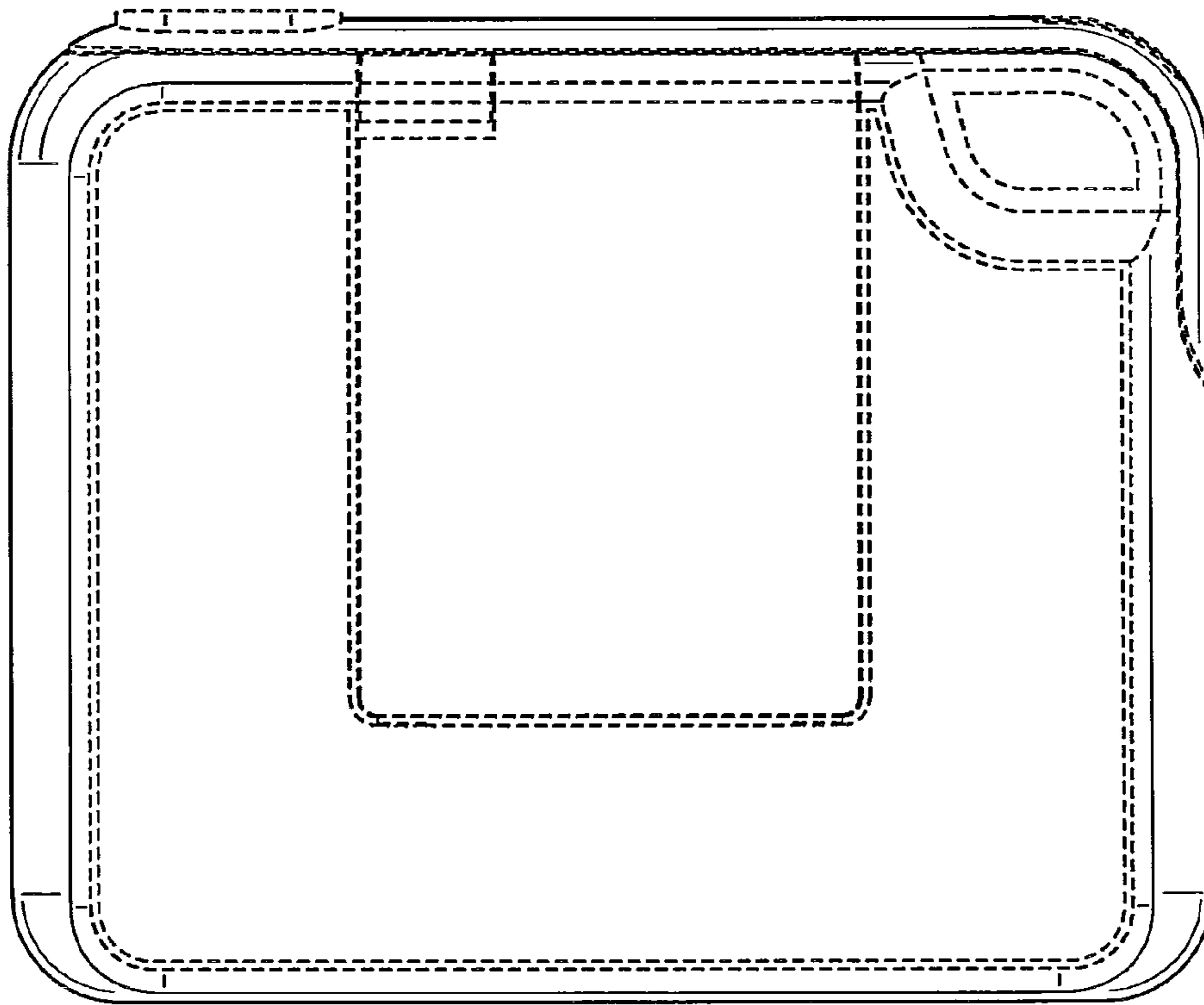

FIG. 3

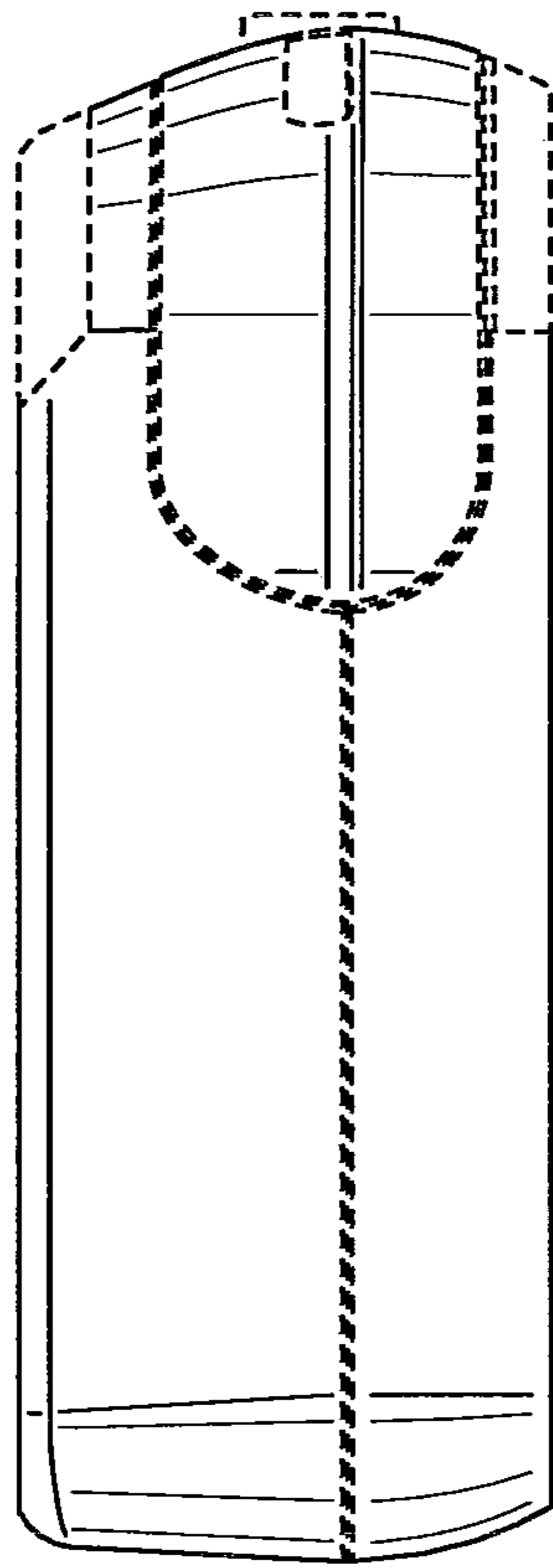

FIG. 4

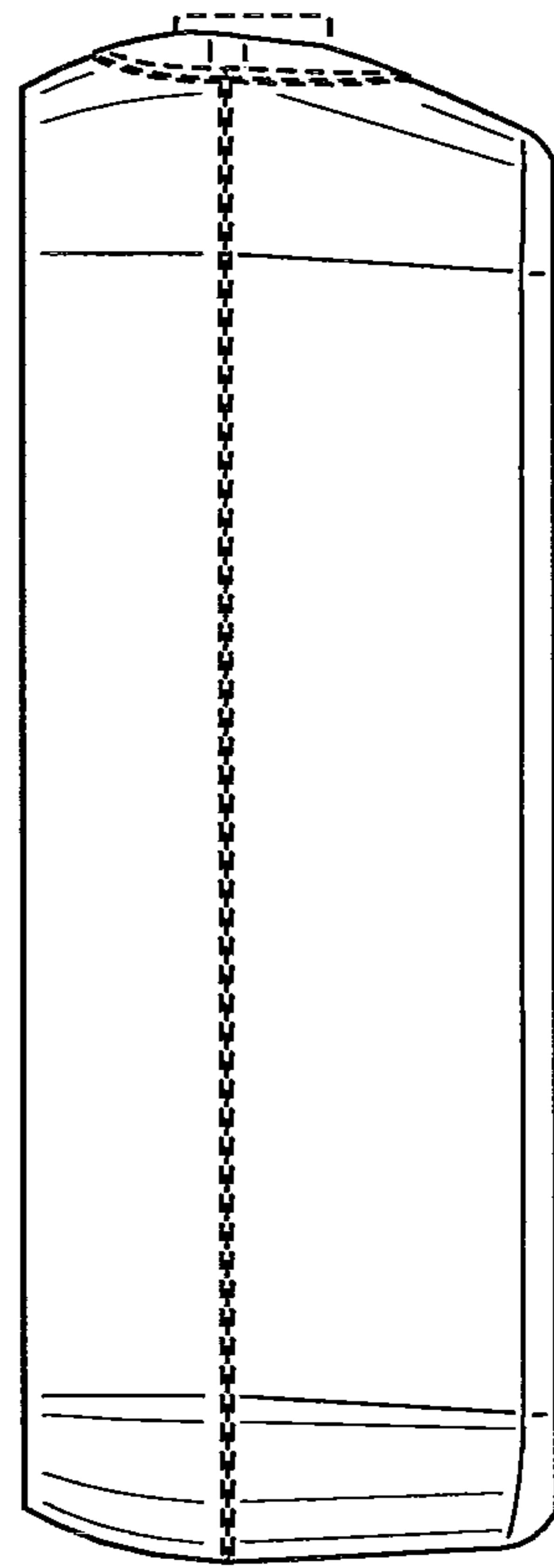

FIG. 5

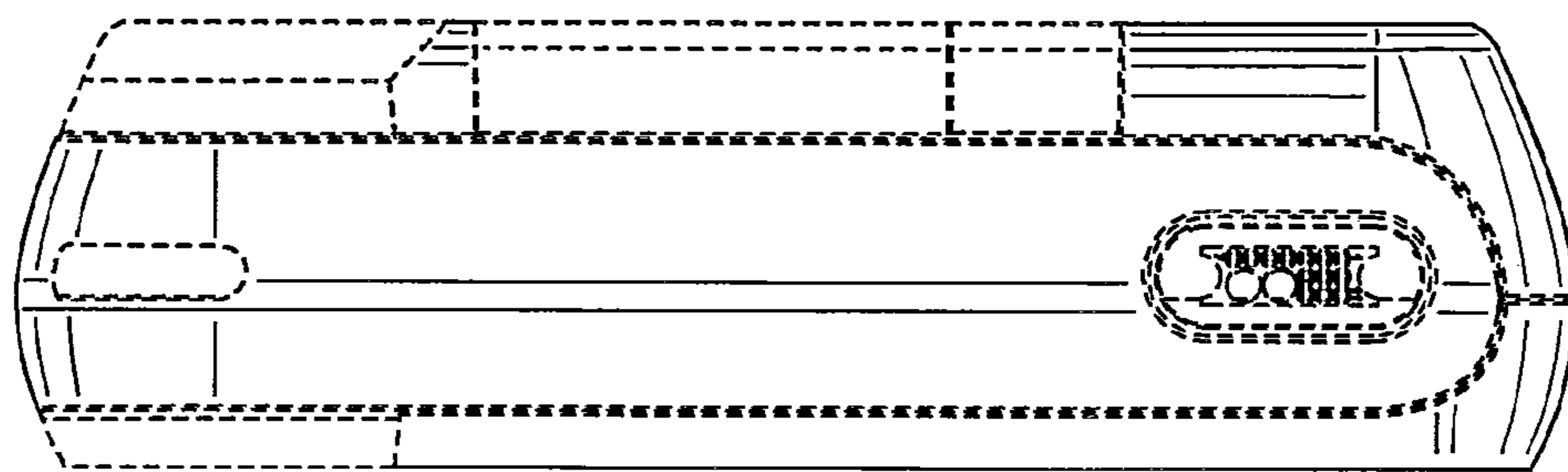

FIG. 6

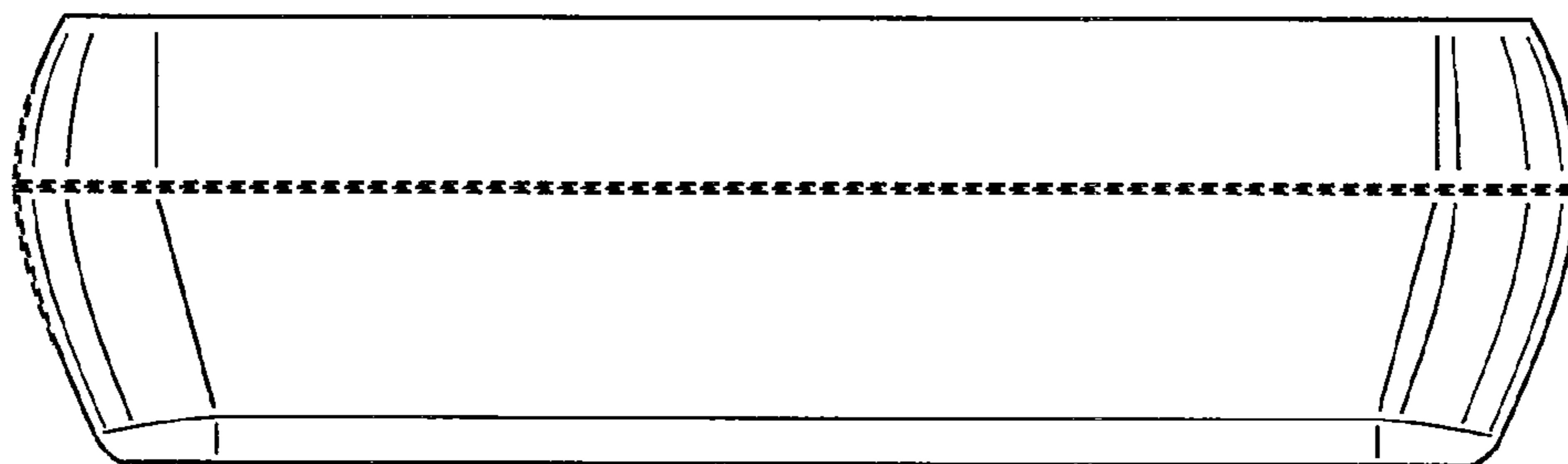

FIG. 7

UNITED STATES PATENT AND TRADEMARK OFFICE
CERTIFICATE OF CORRECTION

PATENT NO. : D717,442 S
APPLICATION NO. : 29/459355
DATED : November 11, 2014
INVENTOR(S) : Thomas E. Kaib et al.

Page 1 of 1

It is certified that error appears in the above-identified patent and that said Letters Patent is hereby corrected as shown below:

On the Title Page, Column 1, Item (72) Inventors, Line 1, delete "North Huntingdon, PA" and insert
-- North Huntingdon, PA --

Signed and Sealed this
Tenth Day of March, 2015



Michelle K. Lee
Deputy Director of the United States Patent and Trademark Office