



US00D717347S

(12) **United States Design Patent**
Hatcher

(10) **Patent No.:** **US D717,347 S**
(45) **Date of Patent:** **** Nov. 11, 2014**

- (54) **PURSE LOOM**
- (71) Applicant: **Wilton Industries, Inc.**, Woodridge, IL (US)
- (72) Inventor: **Ken Hatcher**, Smyrna, TN (US)
- (73) Assignee: **Wm. Wright Company**, Antioch, TN (US)
- (**) Term: **14 Years**
- (21) Appl. No.: **29/465,762**
- (22) Filed: **Aug. 30, 2013**
- (51) **LOC (10) Cl.** **15-06**
- (52) **U.S. Cl.**
USPC **D15/66**
- (58) **Field of Classification Search**
USPC D15/66, 72, 78; 66/3, 4, 1 R; 139/29, 139/34; D28/7
See application file for complete search history.

- 2,703,482 A 3/1955 Auran
- 2,726,434 A 12/1955 Knoblock et al.
- 3,054,277 A 9/1962 Broschard
- 3,220,439 A 11/1965 Davis
- D204,442 S * 4/1966 Brawley D15/66
- 3,294,124 A 12/1966 Berger
- 3,636,987 A 1/1972 Forby
- 3,678,709 A 7/1972 Nowicki et al.
- 3,688,357 A 9/1972 Nielsen et al.
- 3,739,437 A 6/1973 Alberici et al.
- 3,753,273 A 8/1973 Roberts
- 3,800,372 A 4/1974 Daoust
- 3,827,091 A 8/1974 Hocevar
- 3,967,467 A 7/1976 Leach, Sr.
- 4,072,173 A 2/1978 Markowitz et al.
- 4,158,296 A 6/1979 Dunlop
- 4,248,063 A 2/1981 Wang
- 4,393,668 A 7/1983 Leach, Sr.
- D273,588 S * 4/1984 Barrett D15/66
- 4,787,219 A 11/1988 Sato et al.
- 4,881,381 A 11/1989 Townsend
- D310,672 S * 9/1990 Harvey et al. D15/66

(Continued)

Primary Examiner — Thomas Johannes
Assistant Examiner — Khawaja Anwar
(74) *Attorney, Agent, or Firm* — Foley & Lardner LLP

(56) **References Cited**

U.S. PATENT DOCUMENTS

- 735,177 A 8/1903 Truesdell
- 1,318,465 A * 10/1919 Seifarth 66/4
- 1,500,383 A 7/1924 Gourie
- 1,694,849 A 12/1928 Fuji
- 1,705,860 A 3/1929 Hagihara
- 1,718,140 A 6/1929 Hagihara
- 1,776,561 A 9/1930 Croix
- 1,997,539 A 4/1935 Bechhofer
- 2,072,668 A 3/1937 Eltgroth
- 2,186,692 A 1/1940 Boyer et al.
- 2,270,619 A 1/1942 Bowyer
- 2,318,018 A 5/1943 Semonsen
- 2,450,067 A 9/1948 Wolff
- 2,609,676 A 9/1952 Womeski
- 2,654,937 A 10/1953 Smith
- 2,663,066 A 12/1953 Berger et al.
- 2,691,878 A 10/1954 Boxer

(57) **CLAIM**

I claim the ornamental design for a purse loom, as shown and described.

DESCRIPTION

FIG. 1 is a perspective view of a purse loom showing our new design;
FIG. 2 is Fin-side (Front) view thereof;
FIG. 3 is a Hook-side (Rear) view thereof;
FIG. 4 is a first end (Right) view thereof;
FIG. 5 is second end (Left) view thereof;
FIG. 6 is a hand grip (Top) view thereof; and,
FIG. 7 is a working view (Bottom) view thereof.

1 Claim, 3 Drawing Sheets

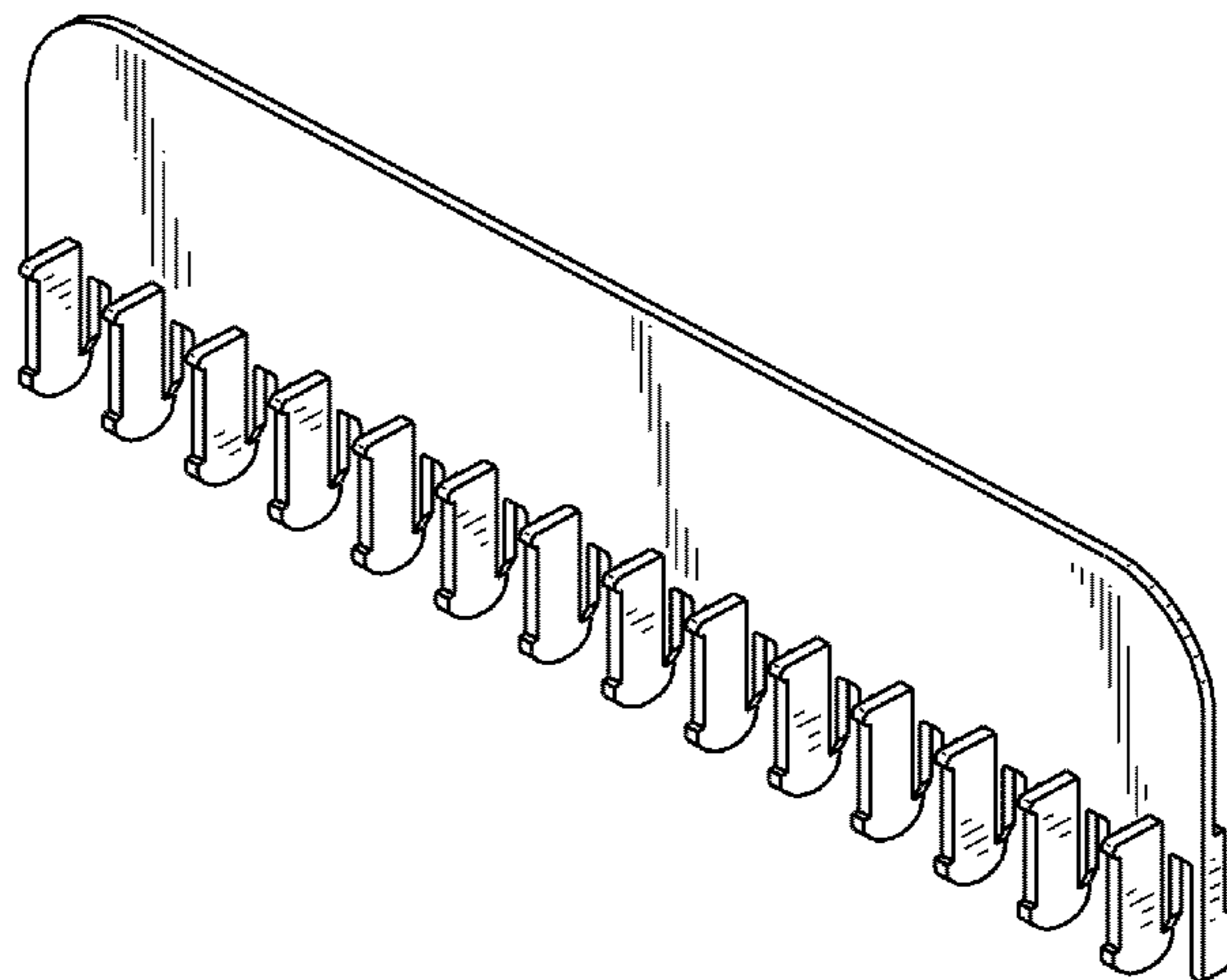

(56)

References Cited

U.S. PATENT DOCUMENTS

5,542,268 A 8/1996 Palange
7,424,898 B2 9/2008 Holly
7,506,524 B2 3/2009 Gustin
7,677,273 B2 3/2010 Skaflestad
7,946,631 B2 5/2011 Crorey

D645,064 S * 9/2011 Basta D15/78
8,172,281 B2 5/2012 Crorey
8,316,894 B2 11/2012 Schaub
8,402,794 B2 3/2013 Sasur
D706,977 S * 6/2014 Langley et al. D28/7
2008/0223083 A1 * 9/2008 Gustin 66/1 A
2013/0038008 A1 2/2013 Hall

* cited by examiner

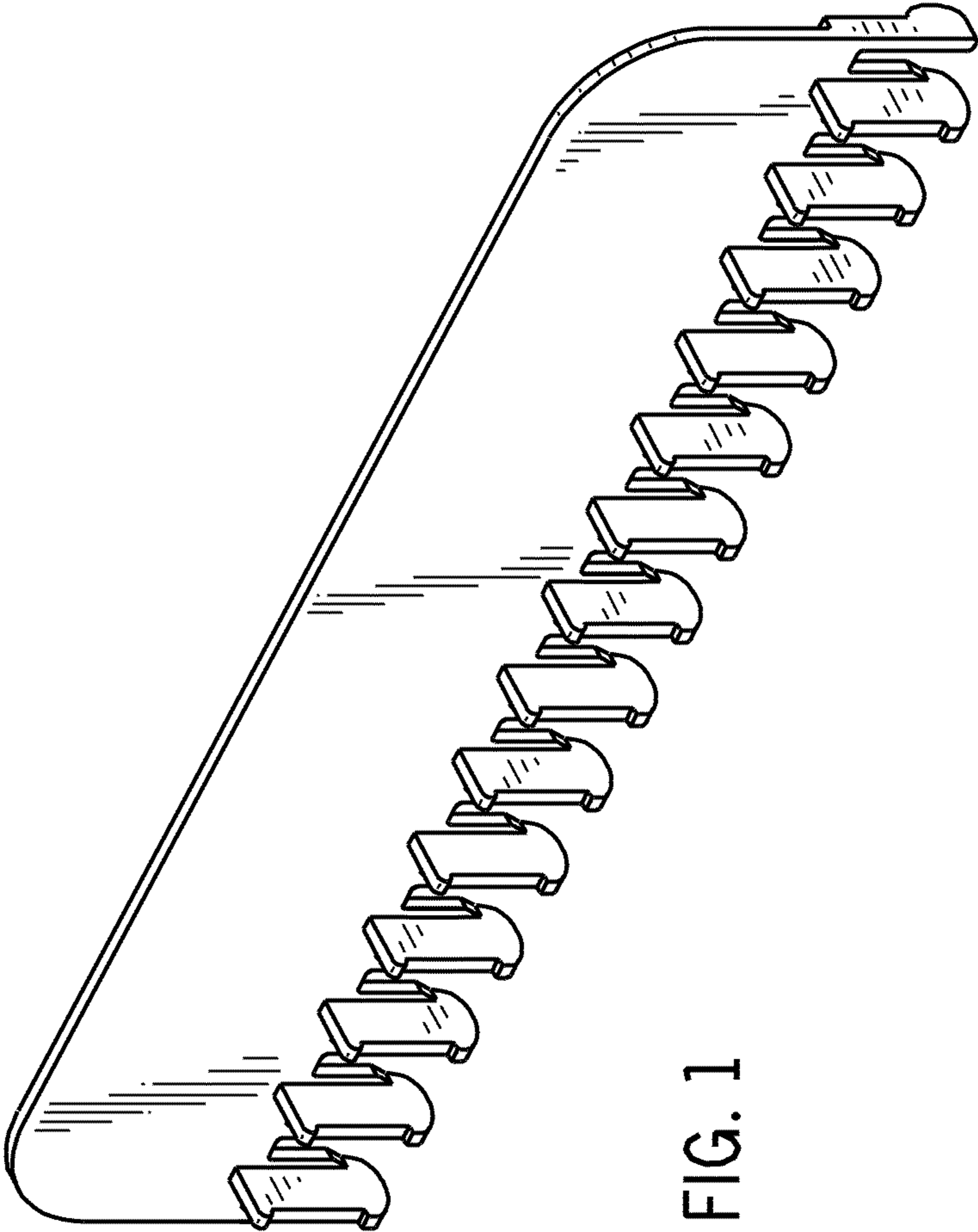

FIG. 1

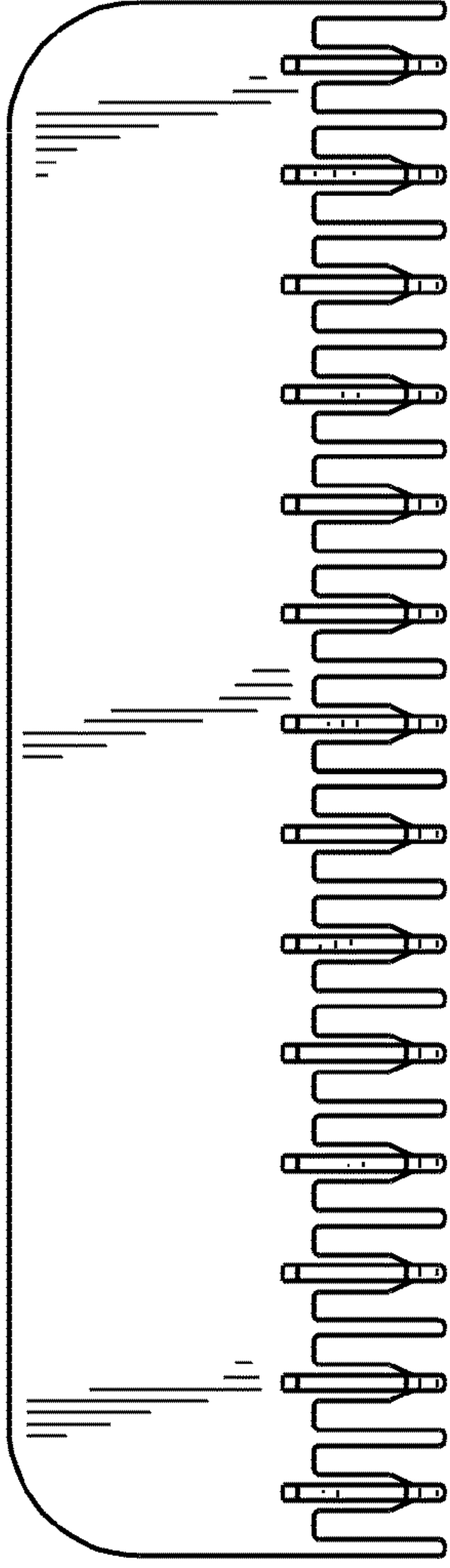

FIG. 2

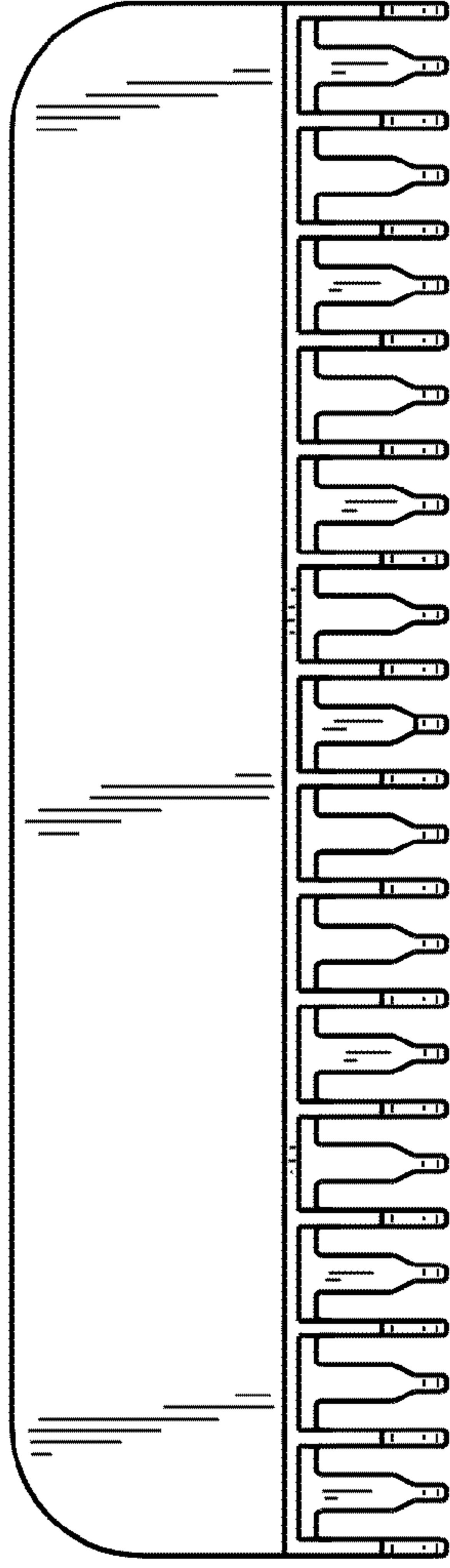

FIG. 3

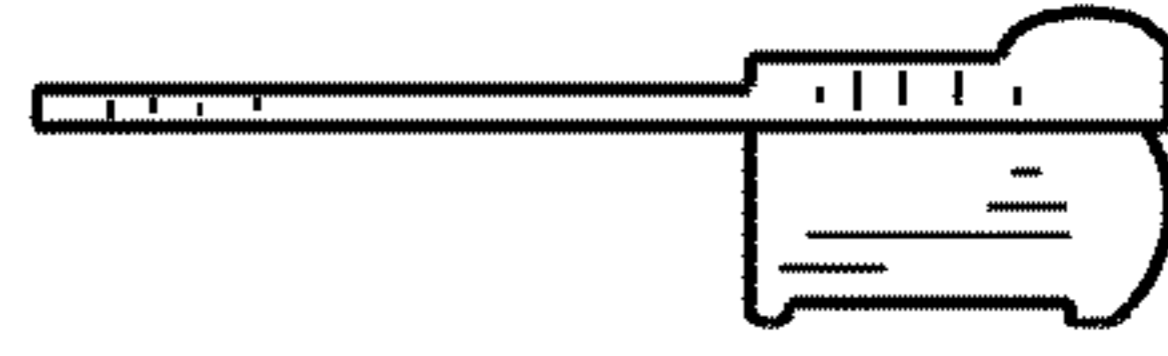

FIG. 4

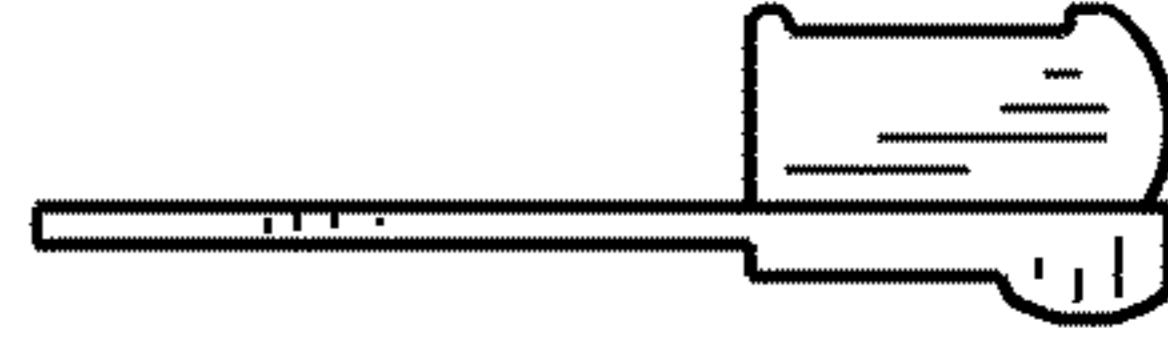

FIG. 5

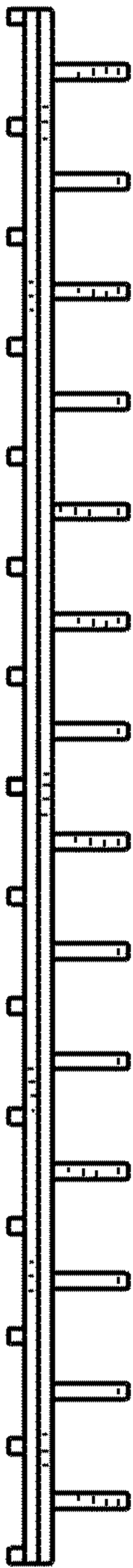

FIG. 6

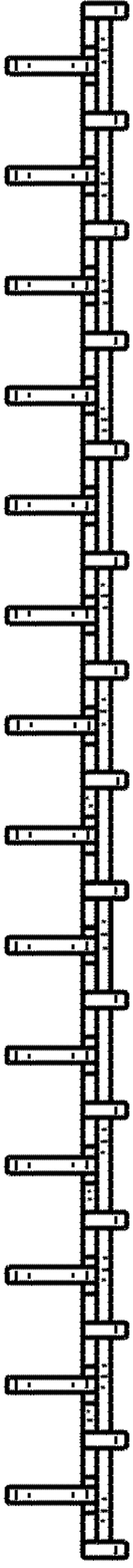

FIG. 7