

US00D717335S

(12) **United States Design Patent**
Sakuma

(10) **Patent No.:** **US D717,335 S**

(45) **Date of Patent:** **** Nov. 11, 2014**

(54) **DISPLAY SCREEN OF DIGITAL CAMERA**

(71) Applicant: **Fujifilm Corporation**, Tokyo (JP)

(72) Inventor: **Nanae Sakuma**, Tokyo (JP)

(73) Assignee: **Fujifilm Corporation**, Tokyo (JP)

(**) Term: **14 Years**

(21) Appl. No.: **29/445,922**

(22) Filed: **Feb. 19, 2013**

(30) **Foreign Application Priority Data**

Aug. 21, 2012 (JP) 2012-019954

(51) **LOC (10) Cl.** **14-04**

(52) **U.S. Cl.**
USPC **D14/487; D16/200**

(58) **Field of Classification Search**
USPC D16/200; D14/487, 490, 317; 715/700,
715/764, 810, 835, 837, 840, 846, 847
See application file for complete search history.

(56) **References Cited**

U.S. PATENT DOCUMENTS

D270,271 S * 8/1983 Steele D18/27
D440,575 S * 4/2001 Wang et al. D14/489

D482,368 S * 11/2003 den Toonder et al. D14/486
6,925,613 B2 * 8/2005 Gibson 715/864
D676,060 S * 2/2013 Frost et al. D14/490
D682,882 S * 5/2013 Cahill et al. D14/495
D708,203 S * 7/2014 Johnson D14/487

* cited by examiner

Primary Examiner — Cynthia Underwood

(74) *Attorney, Agent, or Firm* — Jean C. Edwards, Esq.;
Edwards Neils PLLC

(57) **CLAIM**

The ornamental design for a display screen of digital camera,
as shown and described.

DESCRIPTION

FIG. 1 is a rear view of the display screen of digital camera,
shown enlarged and separated from the digital camera, showing
my new design;

FIG. 2 is a rear view of the display screen of digital camera;

FIG. 3 is a front view thereof;

FIG. 4 is a left side view thereof;

FIG. 5 is a right side view thereof;

FIG. 6 is a top plan view thereof; and,

FIG. 7 is a bottom view thereof.

The portions in broken lines are for illustrative purposes only
and form no part of the claimed design.

1 Claim, 6 Drawing Sheets

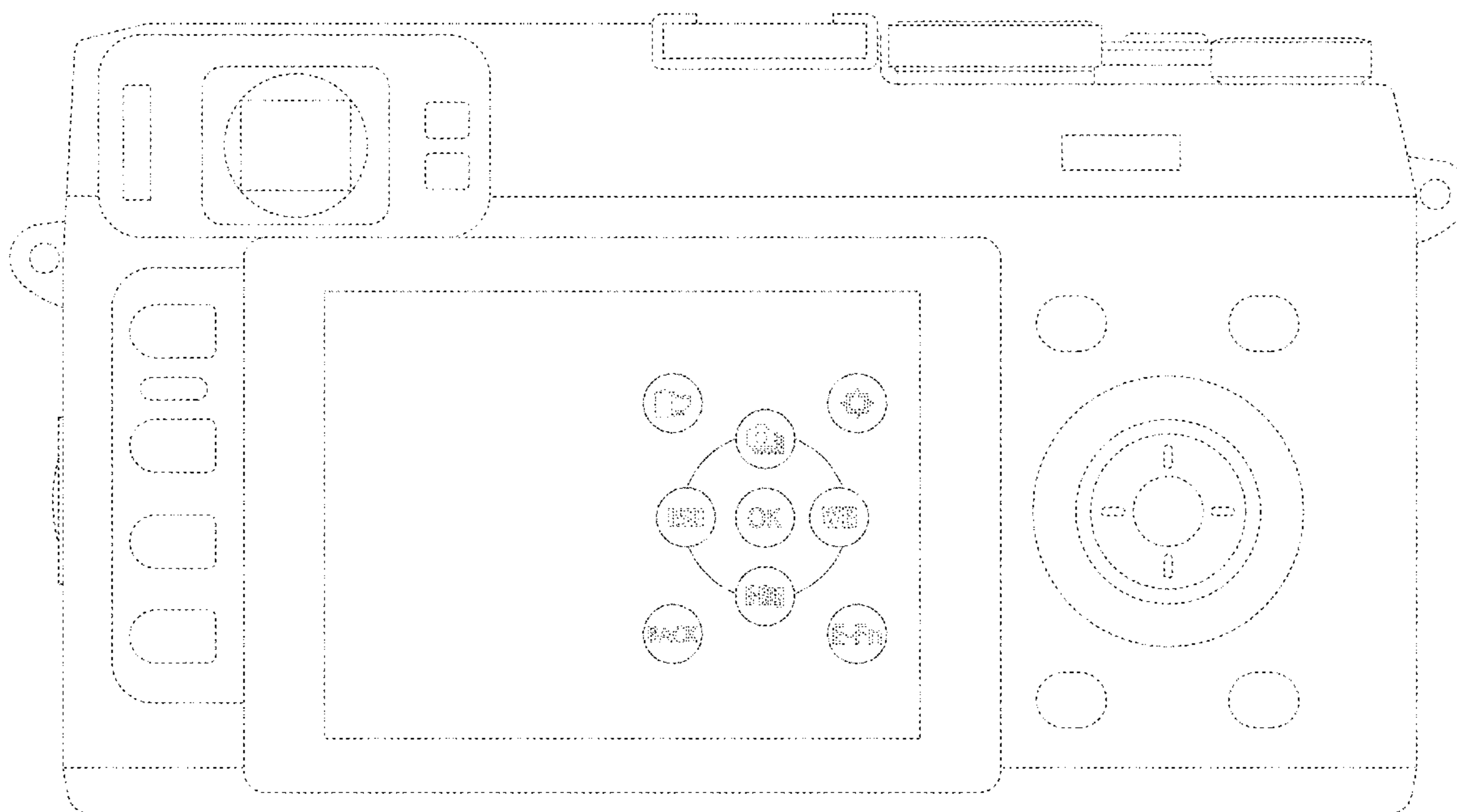

Fig. 1

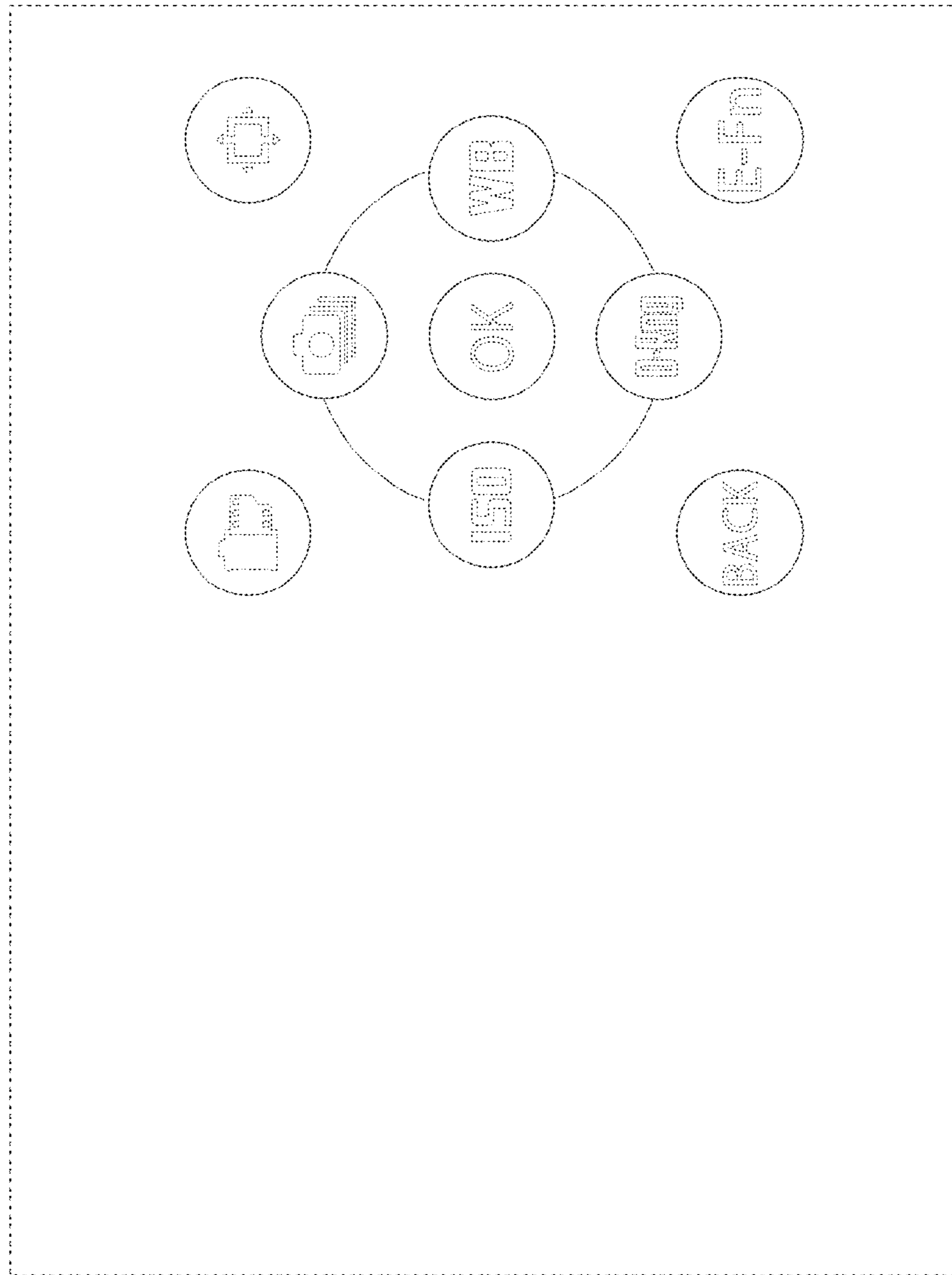

Fig. 2

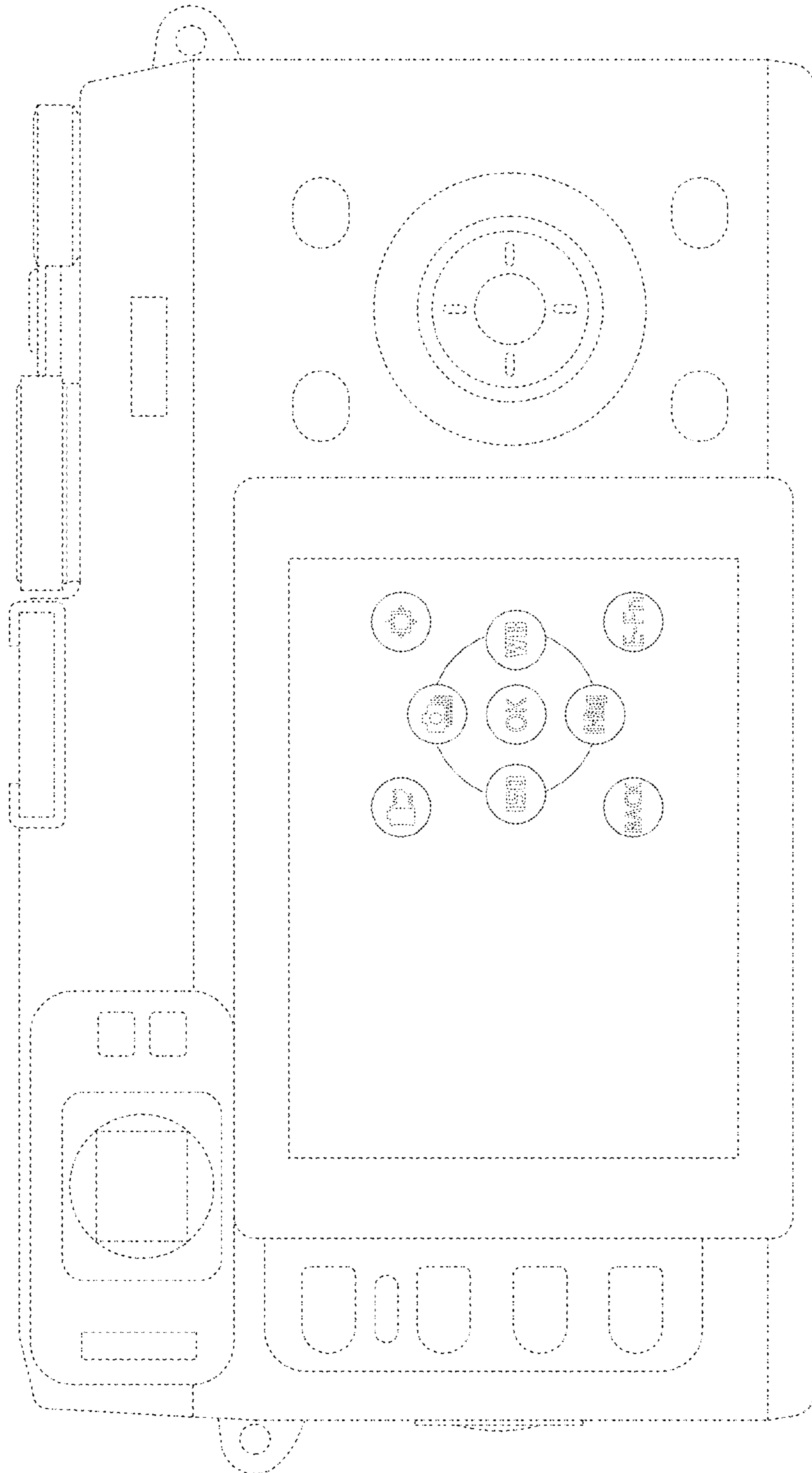

Fig. 3

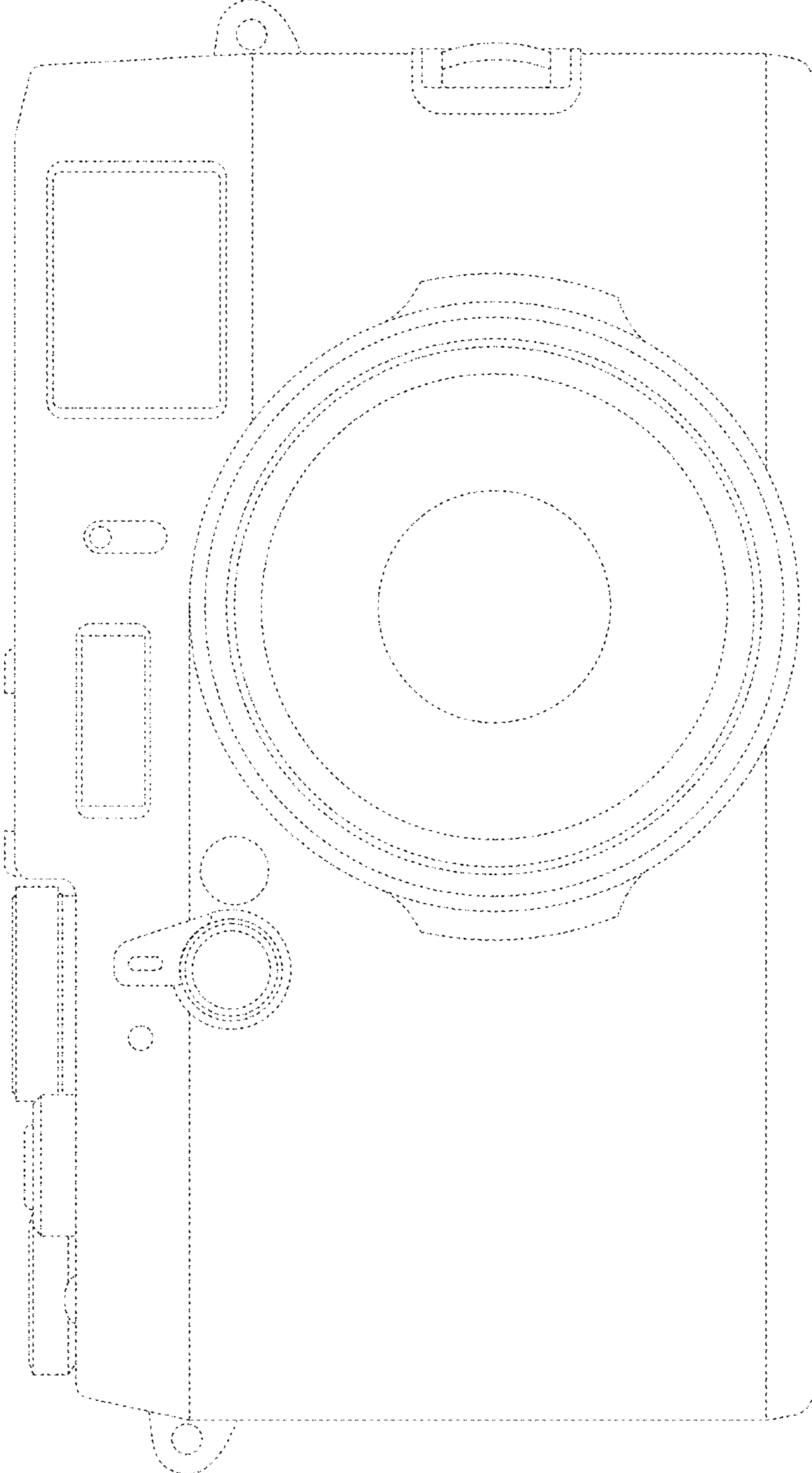

Fig. 5

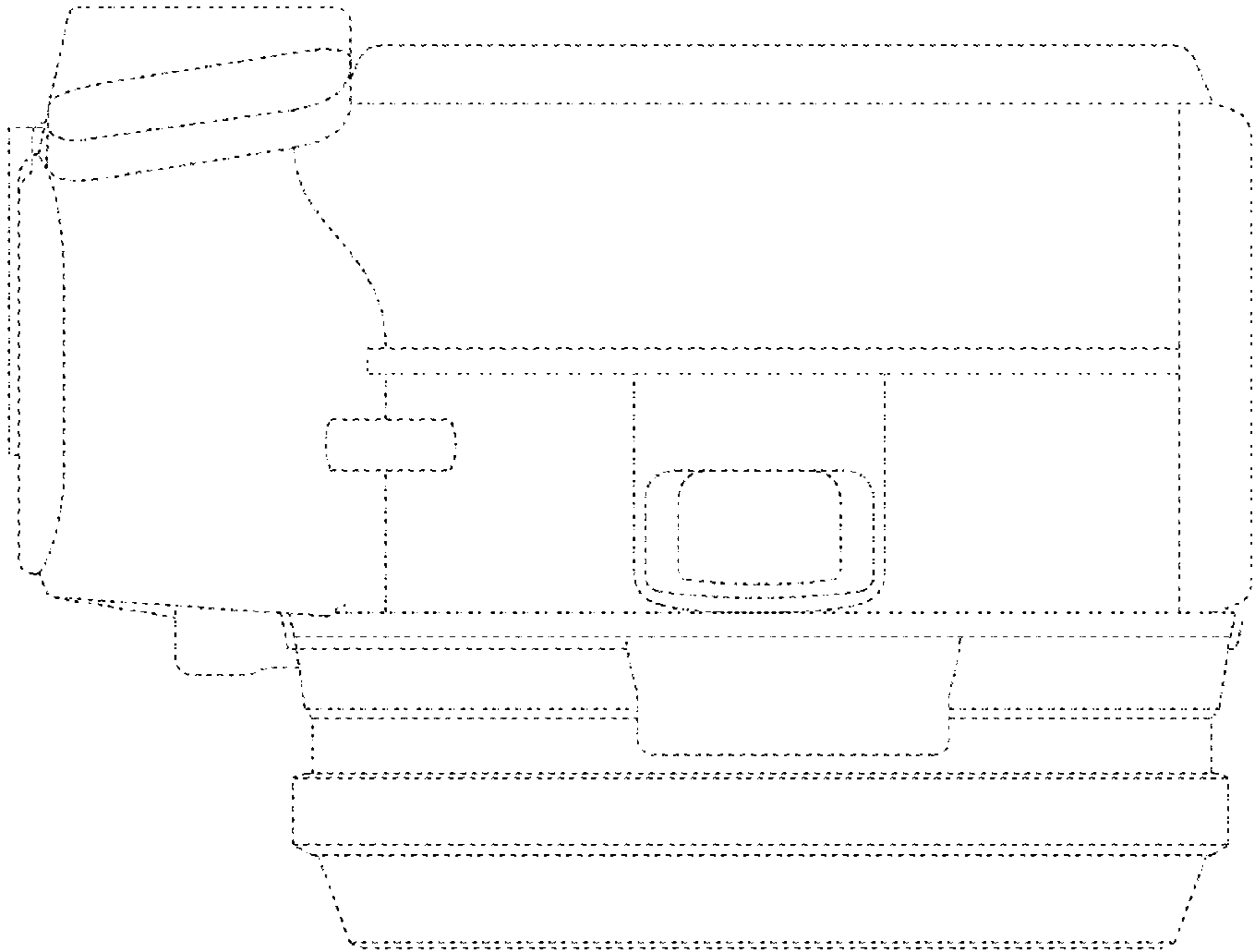

Fig. 4

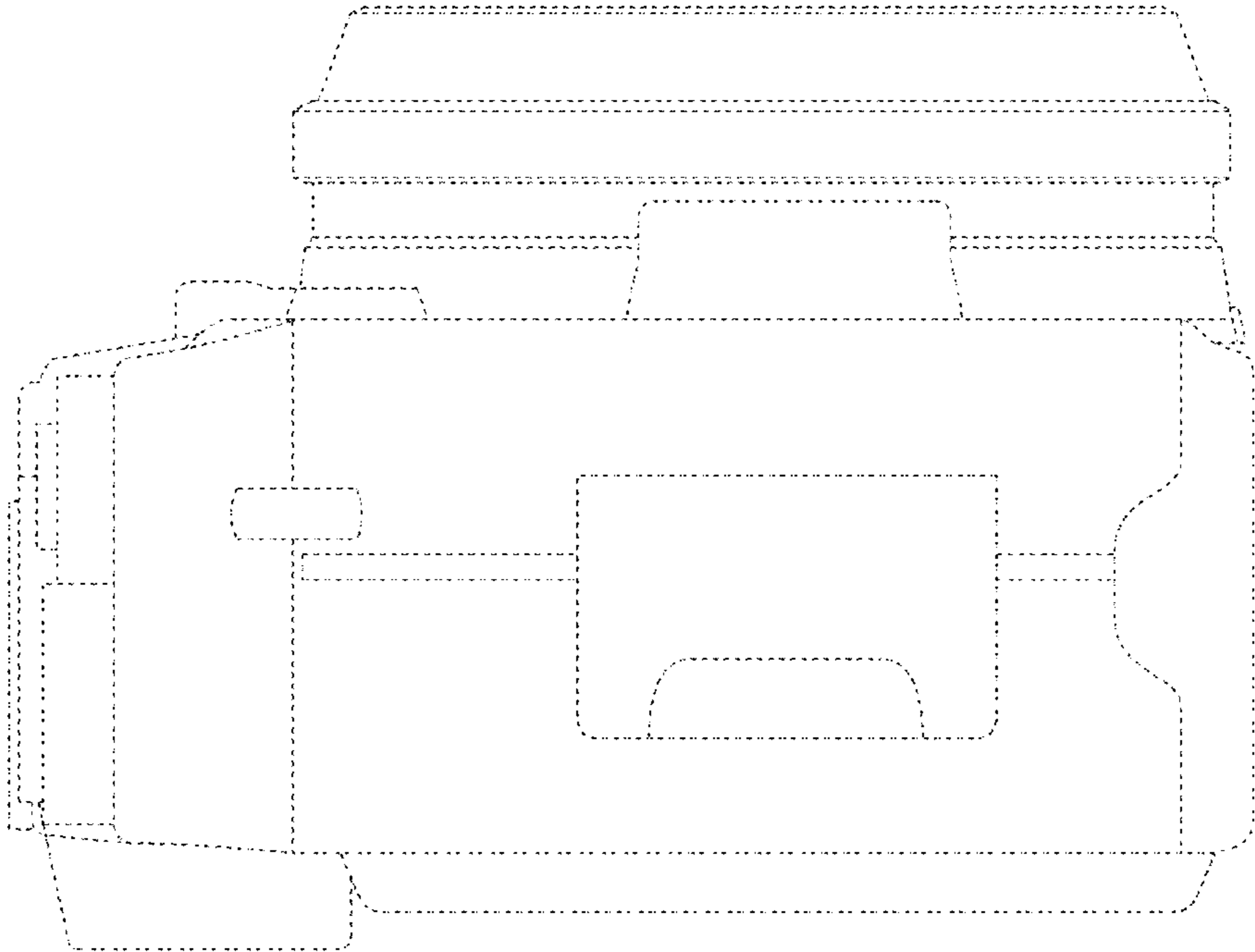

Fig. 6

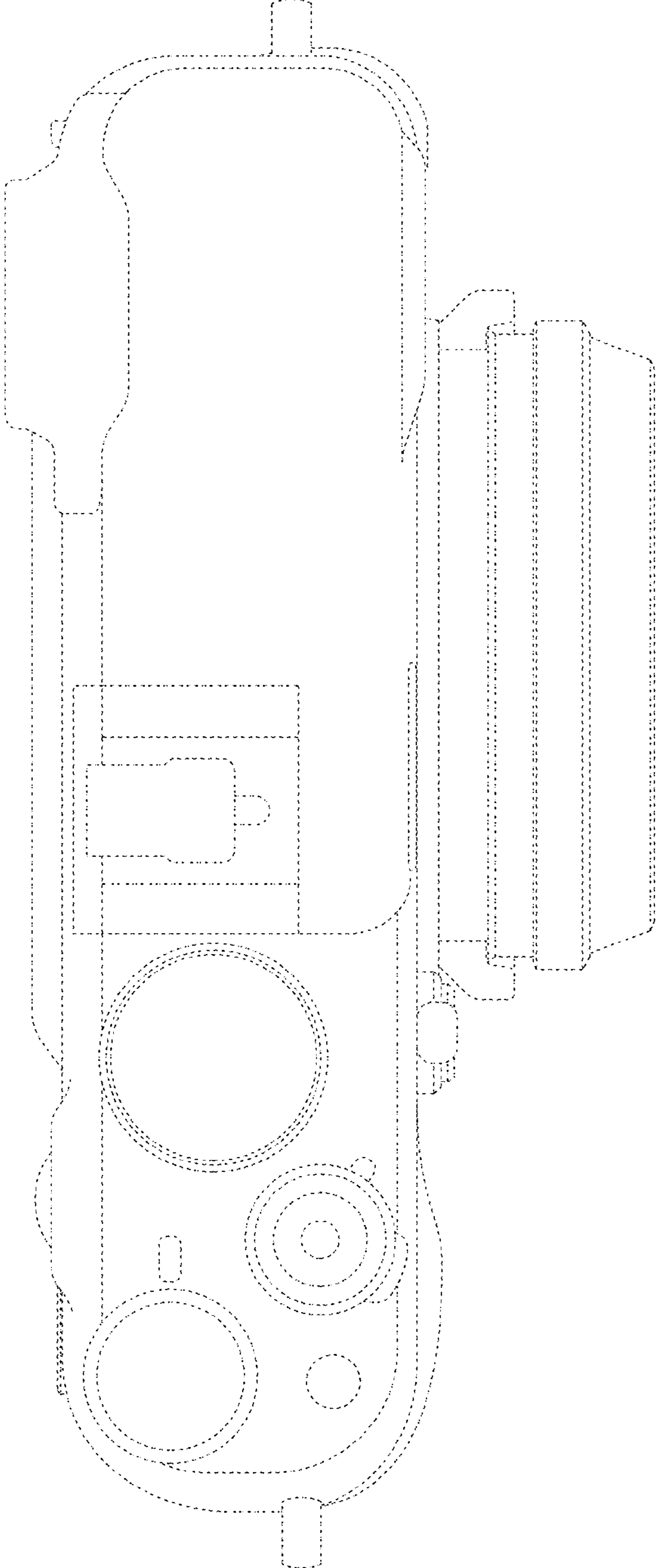

Fig. 7

