



US00D717251S

(12) **United States Design Patent**
Mueller et al.

(10) **Patent No.:** **US D717,251 S**

(45) **Date of Patent:** **** Nov. 11, 2014**

(54) **HEAT SPREADER WITH FINS AND TOP BAR ON A MEMORY MODULE**

(75) Inventors: **Martin Mueller**, Fremont, CA (US);
Thi La, San Jose, CA (US)

(73) Assignee: **Corsair Memory, Inc.**, Fremont, CA (US)

(**) Term: **14 Years**

(21) Appl. No.: **29/427,486**

(22) Filed: **Jul. 18, 2012**

(51) **LOC (10) Cl.** **13-03**

(52) **U.S. Cl.**
USPC **D13/179**

(58) **Field of Classification Search**
USPC D13/179; 165/80.3, 104.26, 104.33,
165/122, 151, 185; 257/706, 707, 718-722;
361/695, 697, 700, 702, 704, 709, 710,
361/711, 719

See application file for complete search history.

(56) **References Cited**

U.S. PATENT DOCUMENTS

6,297,966	B1 *	10/2001	Lee et al.	361/799
7,365,985	B1 *	4/2008	Ni	361/715
7,382,617	B2 *	6/2008	Yu et al.	361/704
7,391,613	B2 *	6/2008	Lai et al.	361/700
D597,966	S *	8/2009	Shih	D13/179
7,606,035	B2 *	10/2009	Park et al.	361/715
D610,557	S *	2/2010	Chen et al.	D13/179
D626,520	S *	11/2010	Chen et al.	D13/179
D626,521	S *	11/2010	Chen et al.	D13/179

8,081,474	B1 *	12/2011	Zohni et al.	361/719
D657,756	S *	4/2012	Mueller	D13/179
D660,810	S *	5/2012	Mueller	D13/179
2002/0039282	A1 *	4/2002	Han et al.	361/719
2003/0076657	A1 *	4/2003	Summers et al.	361/719
2005/0264998	A1 *	12/2005	McCutcheon et al.	361/702
2007/0070607	A1 *	3/2007	Goodwin	361/719
2007/0263360	A1 *	11/2007	Lai et al.	361/719
2009/0168356	A1 *	7/2009	Chen et al.	361/709
2010/0038054	A1 *	2/2010	Chen et al.	165/80.2
2010/0175852	A1 *	7/2010	Peterson	165/80.2

* cited by examiner

Primary Examiner — Selina Sikder

(74) *Attorney, Agent, or Firm* — Sheppard Mullin Richter & Hampton LLP

(57) **CLAIM**

The ornamental design for a heat spreader with fins and top bar on a memory module, as shown and described.

DESCRIPTION

FIG. 1 is a front right side perspective view of a heat spreader on a memory module showing our new design;
FIG. 2 is a front view thereof;
FIG. 3 is a rear view thereof;
FIG. 4 is a top view thereof;
FIG. 5 is a bottom view thereof;
FIG. 6 is a left side view thereof; and,
FIG. 7 is a right side view thereof.
The shade lines in the figures show contour and not surface ornamentation.

1 Claim, 5 Drawing Sheets

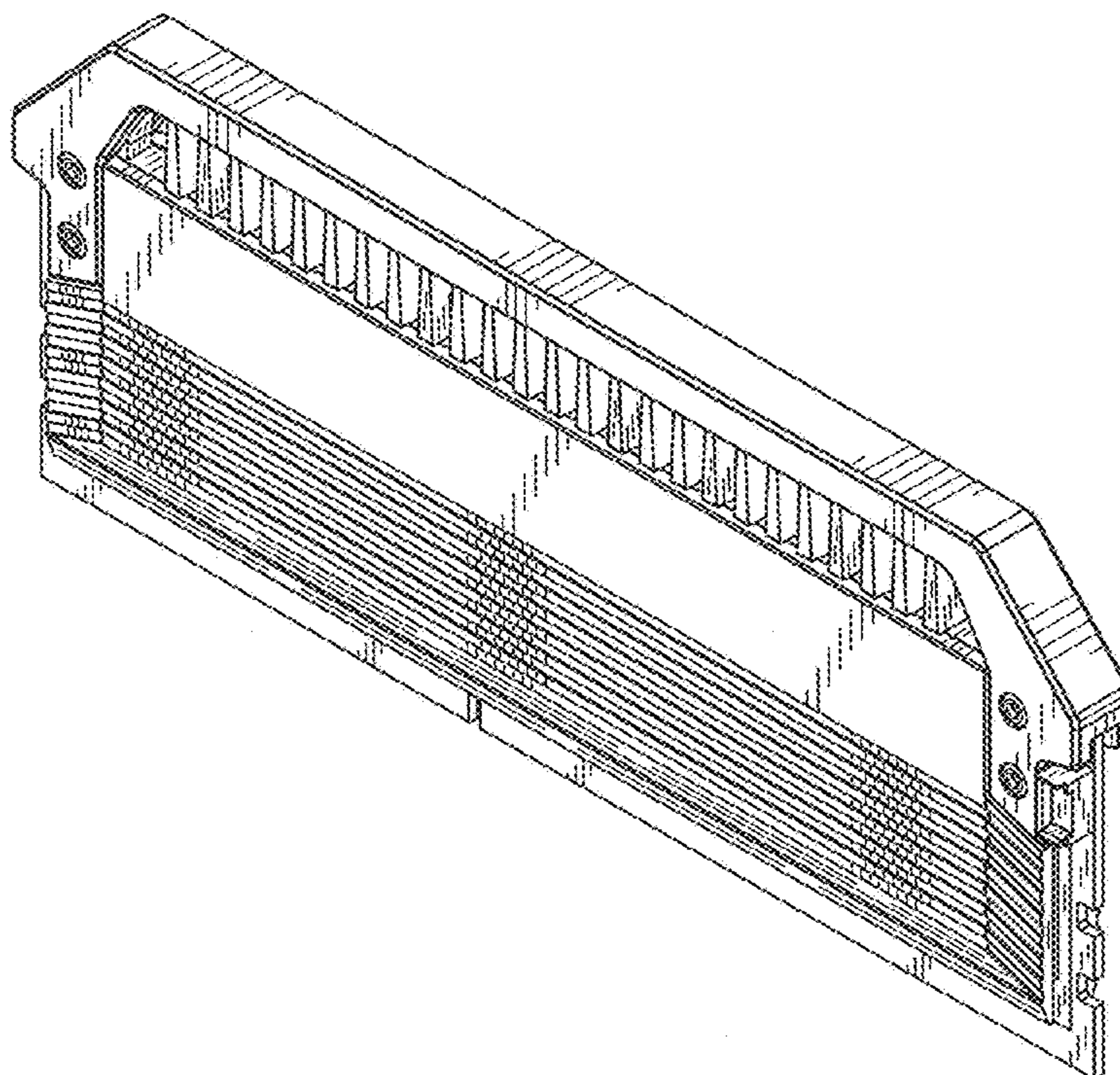

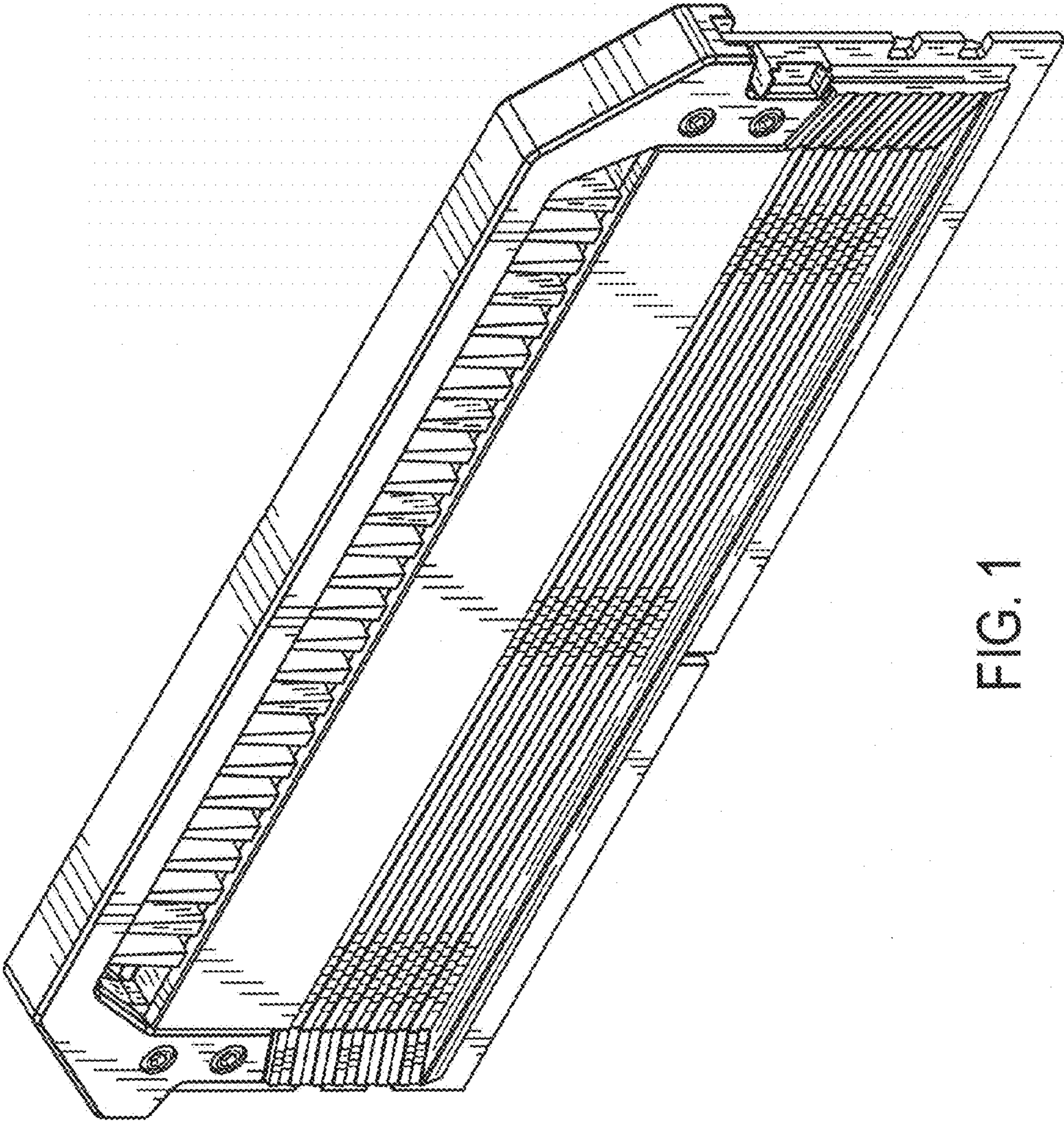

FIG. 1

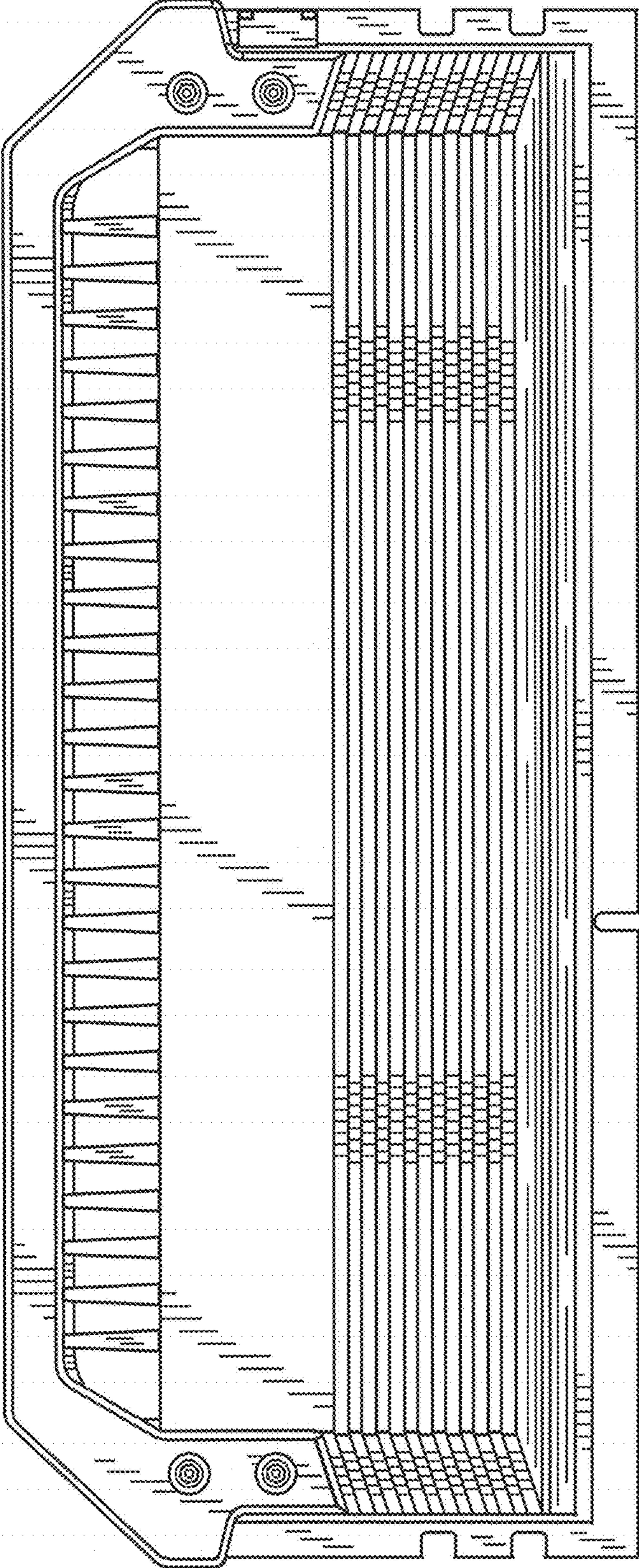

FIG. 2

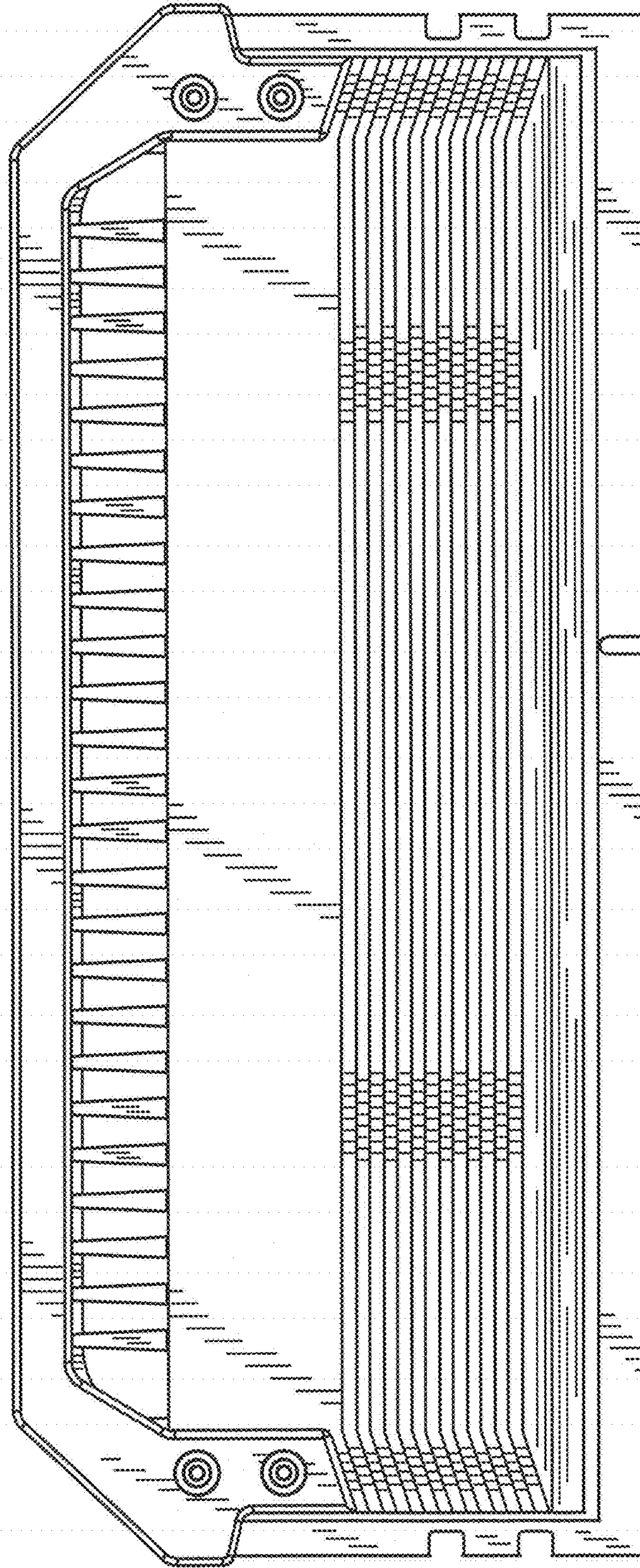

FIG. 3

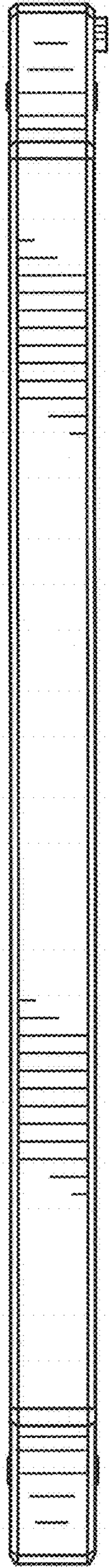

FIG. 4

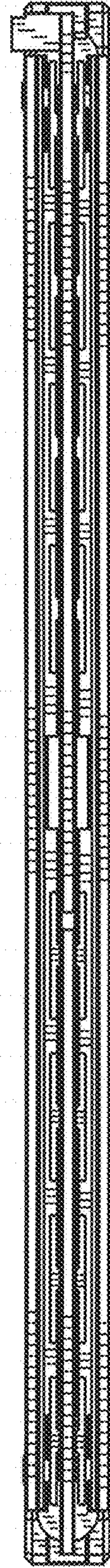

FIG. 5

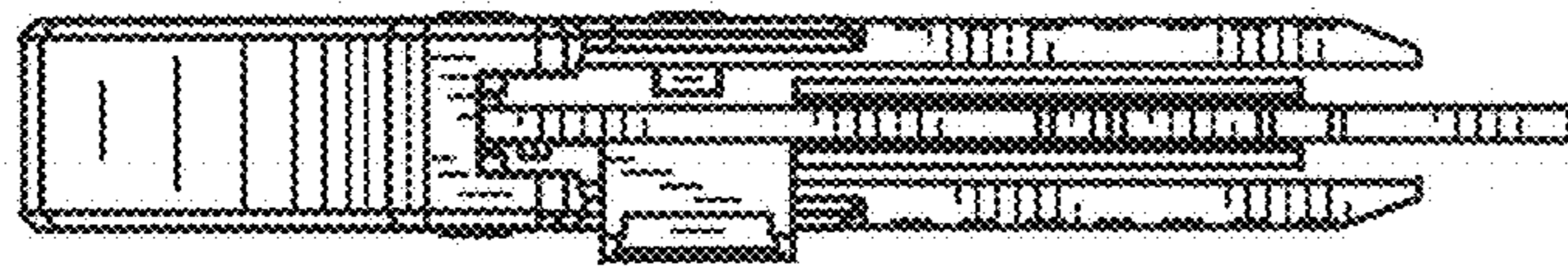

FIG. 7

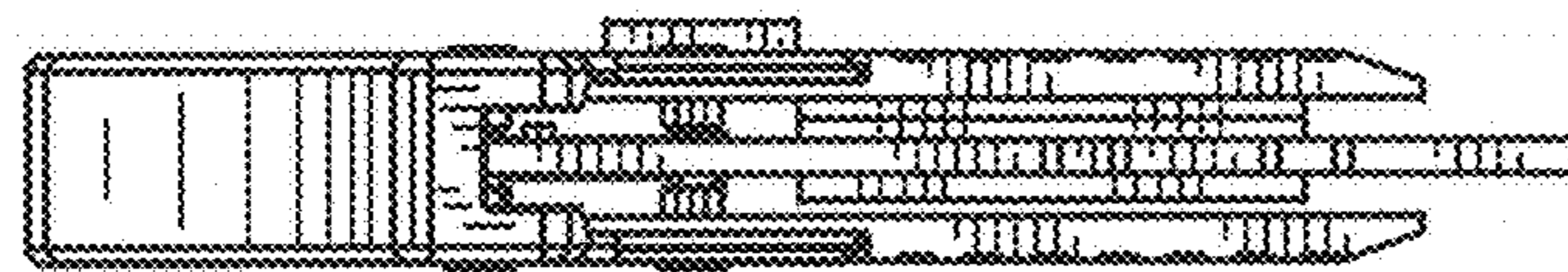

FIG. 6