



US00D717120S

(12) **United States Design Patent**
Carlson

(10) **Patent No.:** **US D717,120 S**

(45) **Date of Patent:** **** *Nov. 11, 2014**

- (54) **CONTAINER BASE**
- (71) Applicant: **The Decor Corporation Pty. Ltd.,**
Scoresby (AU)
- (72) Inventor: **Arthur Richard Carlson,** Hawthorn
East (AU)
- (73) Assignee: **The Decor Corporation Pty. Ltd.,**
Scoresby, Victoria (AU)
- (*) Notice: This patent is subject to a terminal disclaimer.
- (**) Term: **14 Years**
- (21) Appl. No.: **29/455,340**
- (22) Filed: **May 20, 2013**
- (51) **LOC (10) Cl.** **07-07**
- (52) **U.S. Cl.**
USPC **D7/602**
- (58) **Field of Classification Search**
CPC B65D 2251/00
USPC D7/601, 602, 629, 630, 538-542;
D9/424-432; 229/406, 407;
220/780-806, 675, 669-673, 660, 236,
220/326, 324, 4.23-4.25
See application file for complete search history.

3,384,263 A	5/1968	Bernstein
D220,448 S	4/1971	Swett
D224,553 S	8/1972	Swett
D224,554 S	8/1972	Swett
D229,916 S	1/1974	Schneider
D232,703 S	9/1974	Konzi
D234,568 S	3/1975	Swett
D235,406 S	6/1975	Daenen
D238,137 S	12/1975	Swett
D238,148 S	12/1975	Dilot
D240,114 S	6/1976	Martinelli
D241,599 S	9/1976	Croyle
D241,703 S	10/1976	Aston
4,046,310 A	9/1977	Gustafsson
D256,557 S	8/1980	Ikushima et al.
D267,703 S	1/1983	Chase et al.
D281,048 S *	10/1985	Wolff D7/602
D285,906 S	9/1986	Tyler
D287,559 S *	1/1987	Daenen et al. D7/586
D287,573 S	1/1987	Tyler

(Continued)

Primary Examiner — Terry Wallace
(74) *Attorney, Agent, or Firm* — Cook Alex Ltd.

(57) **CLAIM**
The ornamental design for a container base, as shown and described.

DESCRIPTION

FIG. 1 is a front perspective view, from above, of the claimed design;
FIG. 2 is a rear perspective view, from beneath, of the claimed design;
FIG. 3 is a top plan view of the claimed design;
FIG. 4 is an underneath view of the claimed design;
FIG. 5 is a left side view of the claimed design;
FIG. 6 is a right side view of the claimed design;
FIG. 7 is a front view of the claimed design; and,
FIG. 8 is a rear view of the claimed design.

1 Claim, 6 Drawing Sheets

- (56) **References Cited**
U.S. PATENT DOCUMENTS
D3,357 S 2/1869 Pratt
D3,358 S 2/1869 Pratt
D117,714 S 11/1939 Guttman
D162,579 S 3/1951 Roop
D170,104 S 7/1953 Zabel
D186,194 S 9/1959 Beverlin
3,142,413 A 7/1964 Grogel

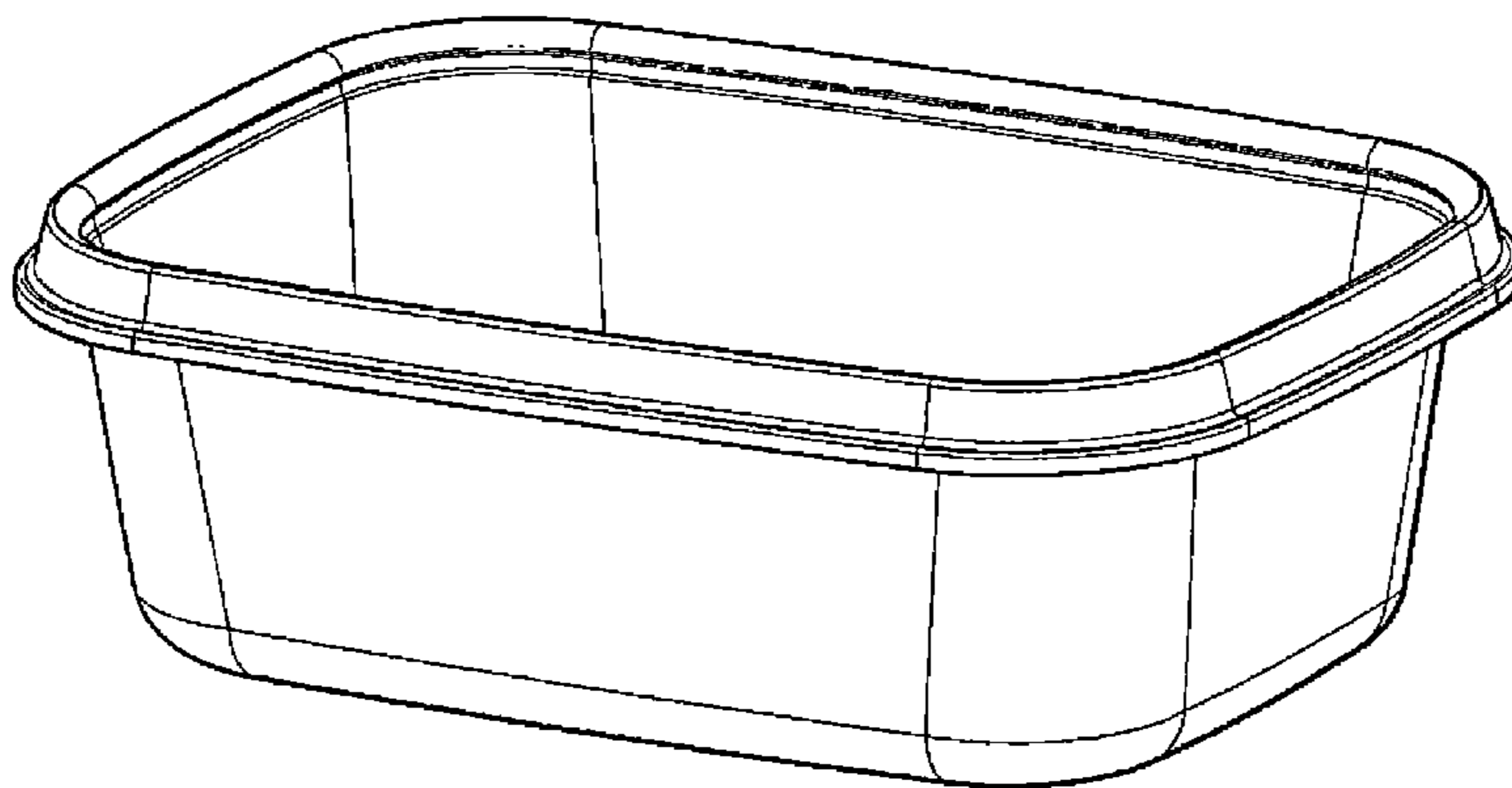

(56)

References Cited

U.S. PATENT DOCUMENTS

D289,719 S	5/1987	Daenen et al.	D548,588 S	*	8/2007	Bouveret et al.	D9/428
4,819,824 A	*	4/1989 Longbottom et al.	D555,476 S		11/2007	Nielsen et al.	
D305,410 S	1/1990	Tyler	D571,200 S		6/2008	Bouveret et al.	
5,065,887 A	11/1991	Schuh et al.	D581,204 S		11/2008	Simon et al.	
D326,391 S	5/1992	Verchere	D584,145 S		1/2009	Young	
D330,660 S	11/1992	Newton et al.	D588,914 S		3/2009	Laurieu-Tedeschi	
D342,817 S	12/1993	Lippisch et al.	D593,855 S		6/2009	Scheve	
D351,791 S	10/1994	Morris, Sr.	D595,128 S		6/2009	Bouveret et al.	
D354,655 S	1/1995	Daenen et al.	D601,386 S		10/2009	Carlson	
D358,328 S	5/1995	Huerto et al.	D601,387 S		10/2009	Carlson	
D360,898 S	8/1995	Huerto et al.	D601,388 S		10/2009	Carlson	
D363,662 S	10/1995	Plater	D601,857 S		10/2009	Carlson	
D365,273 S	12/1995	Indekeu	D614,919 S	*	5/2010	Carlson	D7/602
D375,654 S	11/1996	Ferris	D618,516 S		6/2010	DiPietro et al.	
D375,836 S	11/1996	Conti	D630,899 S		1/2011	Samartgis	
D377,739 S	2/1997	Carlson	D630,900 S		1/2011	Samartgis	
D379,287 S	5/1997	Carlson	D630,901 S		1/2011	Samartgis	
D384,864 S	10/1997	Carlson	D631,299 S		1/2011	Samartgis	
D403,582 S	1/1999	Nask et al.	D631,300 S		1/2011	Samartgis	
D403,583 S	1/1999	Nask et al.	D631,706 S		2/2011	Samartgis	
D403,924 S	1/1999	Carlson	D631,707 S		2/2011	Samartgis	
D404,571 S	1/1999	Evans	D642,905 S		8/2011	Samartgis	
D413,231 S	8/1999	Loew et al.	D642,906 S		8/2011	Samartgis	
D420,859 S	2/2000	Loew et al.	D642,907 S		8/2011	Samartgis	
D428,310 S	7/2000	Zettle et al.	D643,710 S		8/2011	Samartgis	
D440,725 S	4/2001	Zimmerman	D643,711 S		8/2011	Samartgis	
D446,117 S	8/2001	Conti	D643,712 S		8/2011	Samartgis	
D448,133 S	9/2001	Windle	D644,883 S		9/2011	Samartgis	
D457,784 S	5/2002	Torniainen et al.	D644,884 S		9/2011	Samartgis	
D469,320 S	1/2003	Pettaweebuncha	D644,885 S		9/2011	Samartgis	
D484,797 S	1/2004	Kipperman et al.	D644,886 S	*	9/2011	Samartgis	D7/602
D513,376 S	1/2006	Shannon	D644,887 S		9/2011	Samartgis	
D536,248 S	2/2007	Lesquir	D644,888 S		9/2011	Samartgis	
D540,669 S	4/2007	George et al.	D655,576 S		3/2012	Samartgis	
D542,591 S	5/2007	Carlson	D655,577 S		3/2012	Samartgis	
			D655,578 S		3/2012	Samartgis	
			2009/0120937 A1	*	5/2009	Vovan	220/266

* cited by examiner

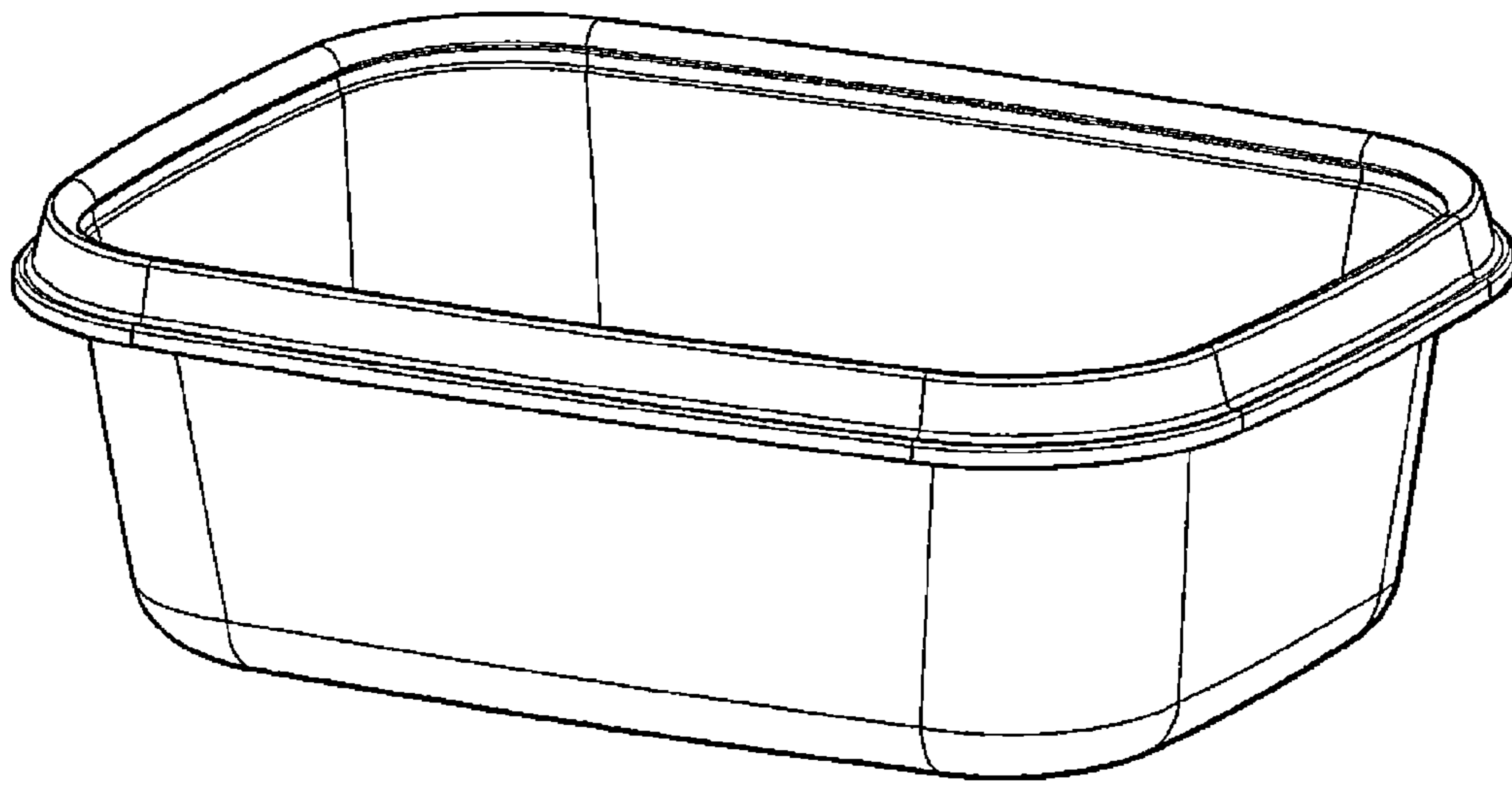

FIG. 1

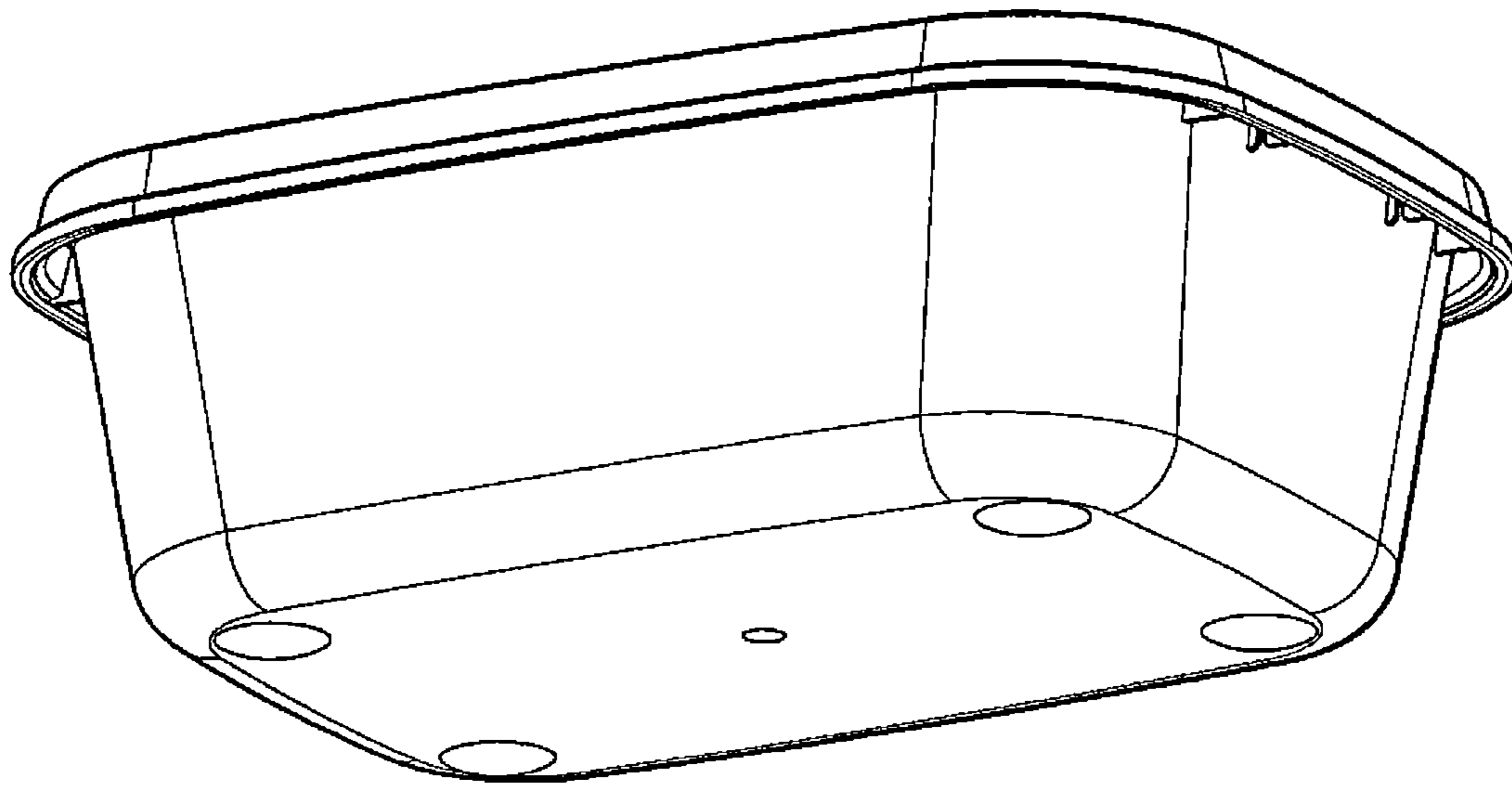

FIG. 2

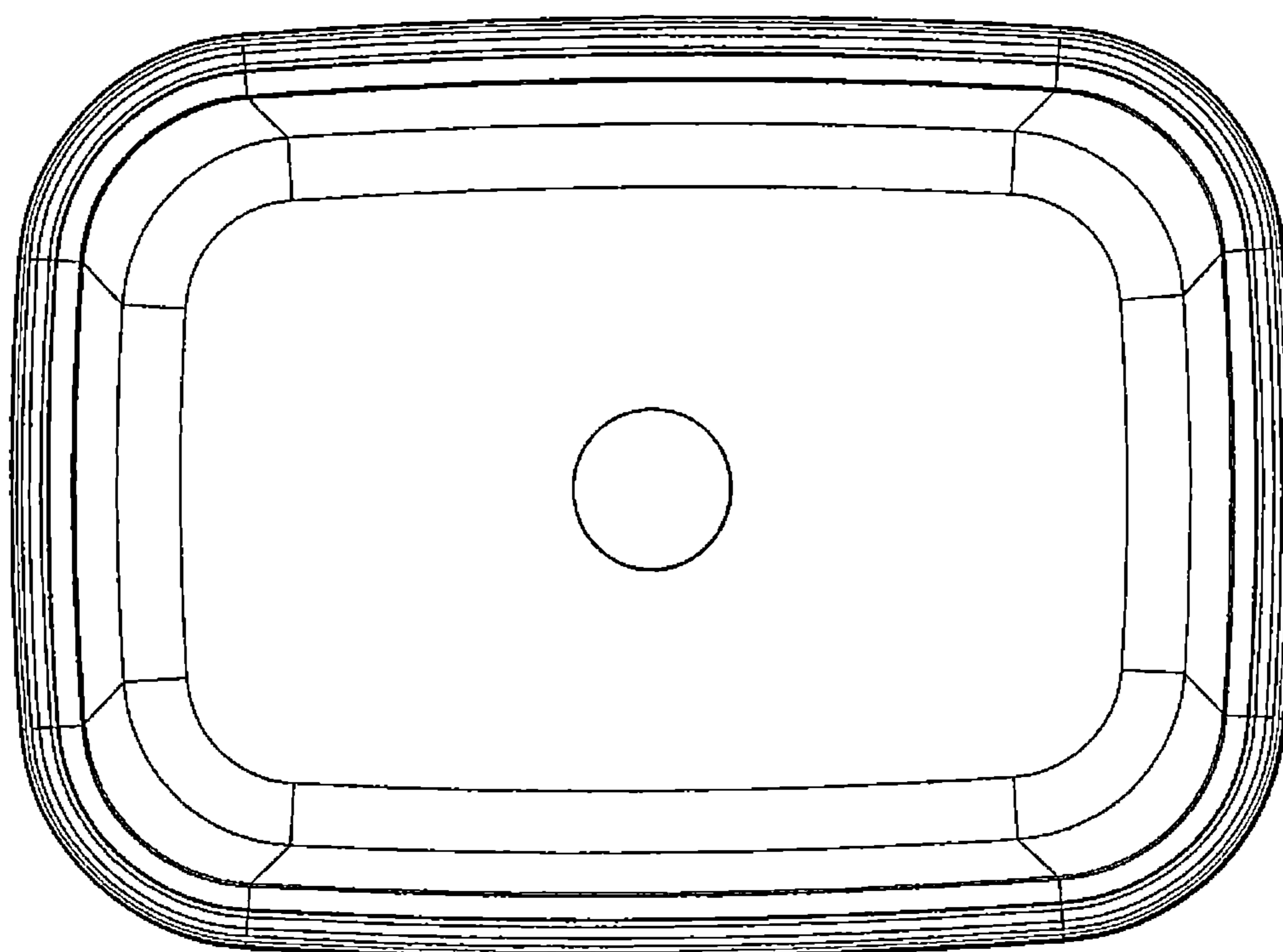

FIG. 3

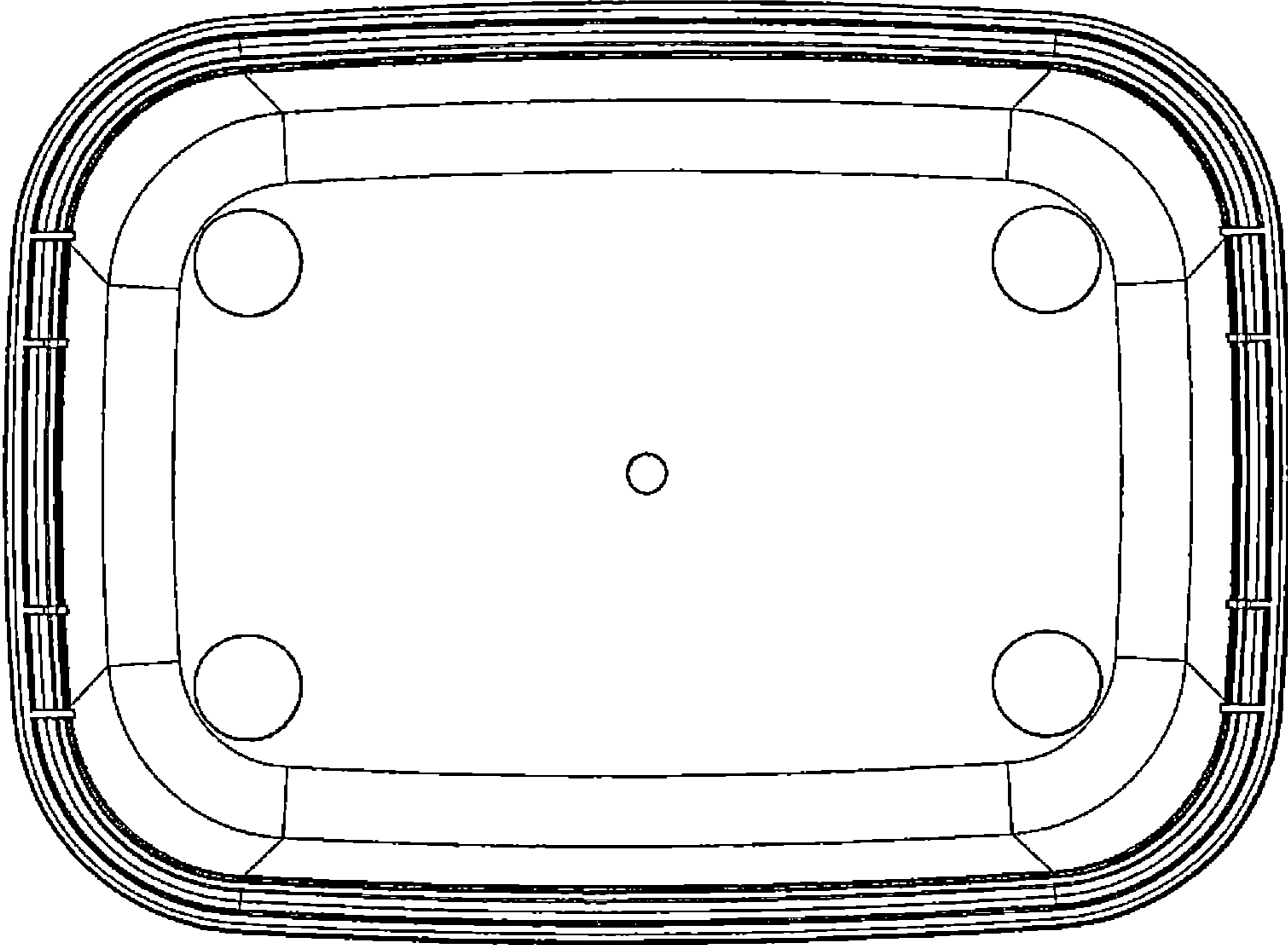

FIG. 4

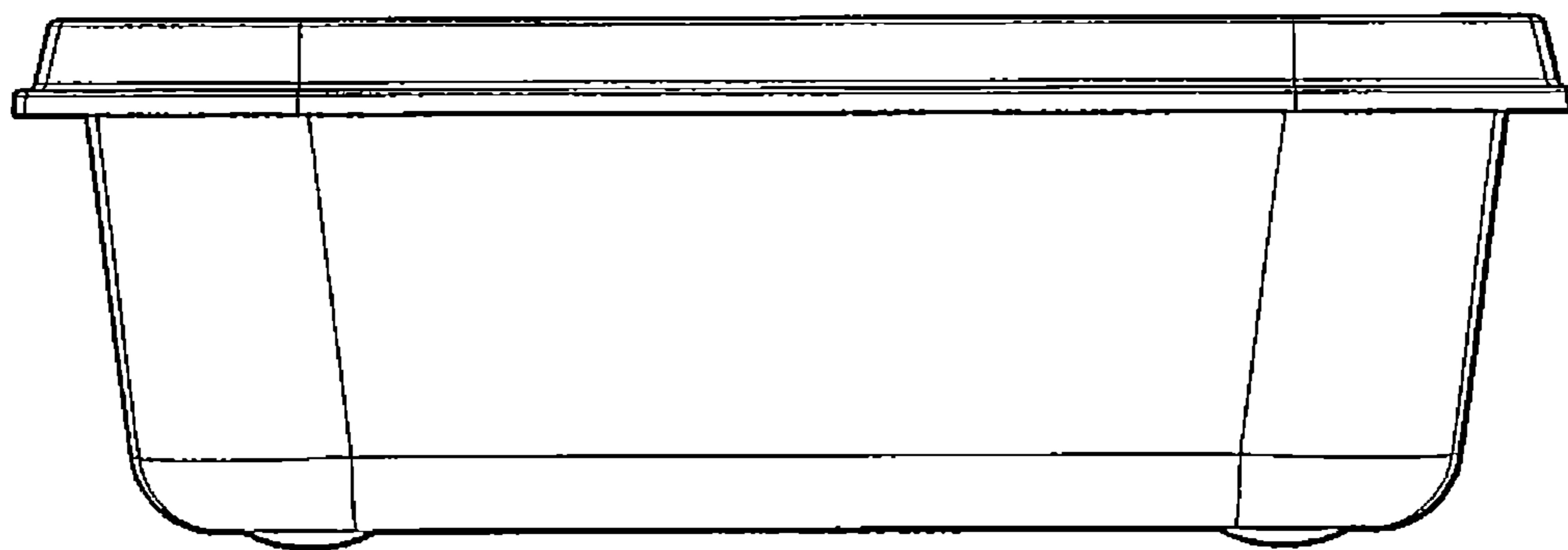

FIG. 5

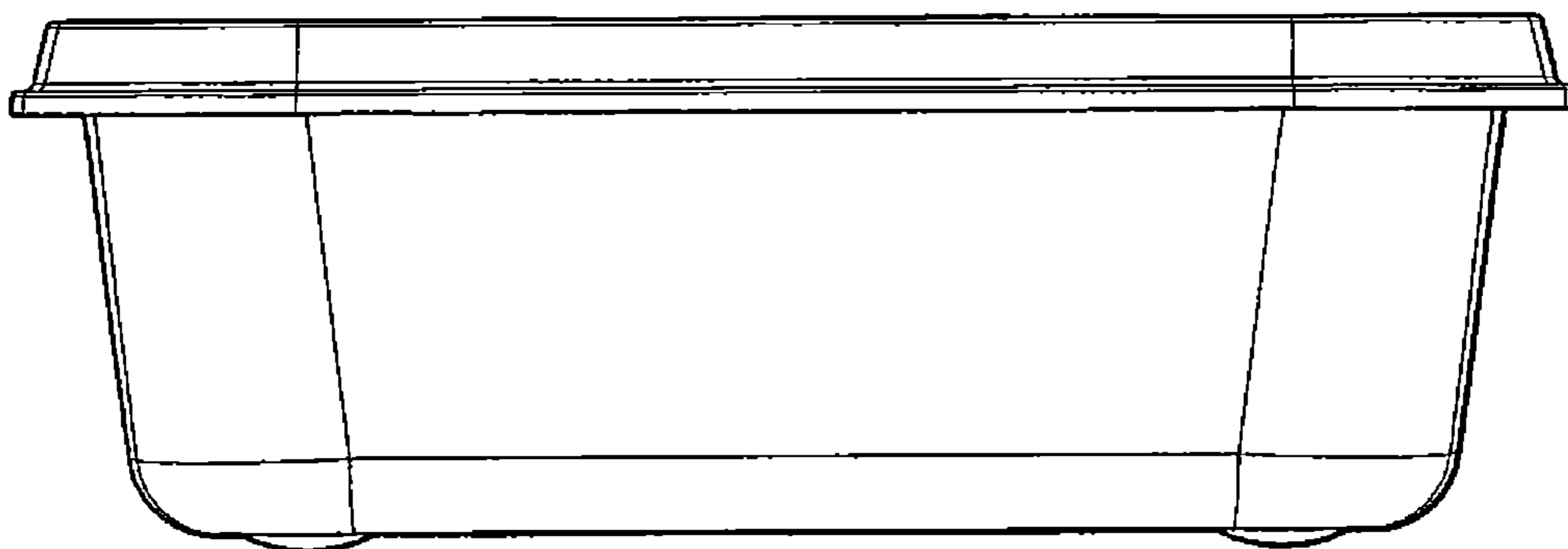

FIG. 6

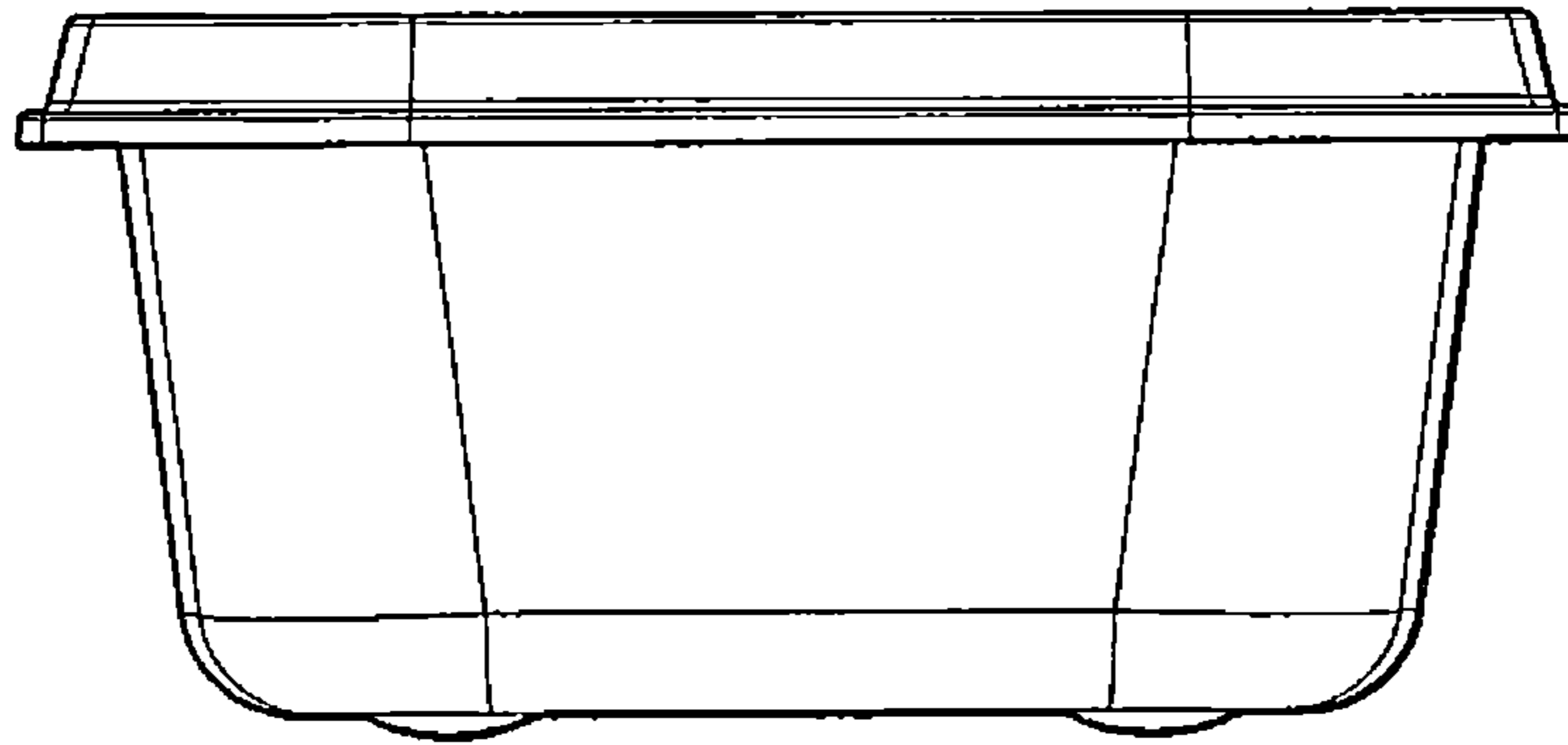

FIG. 7

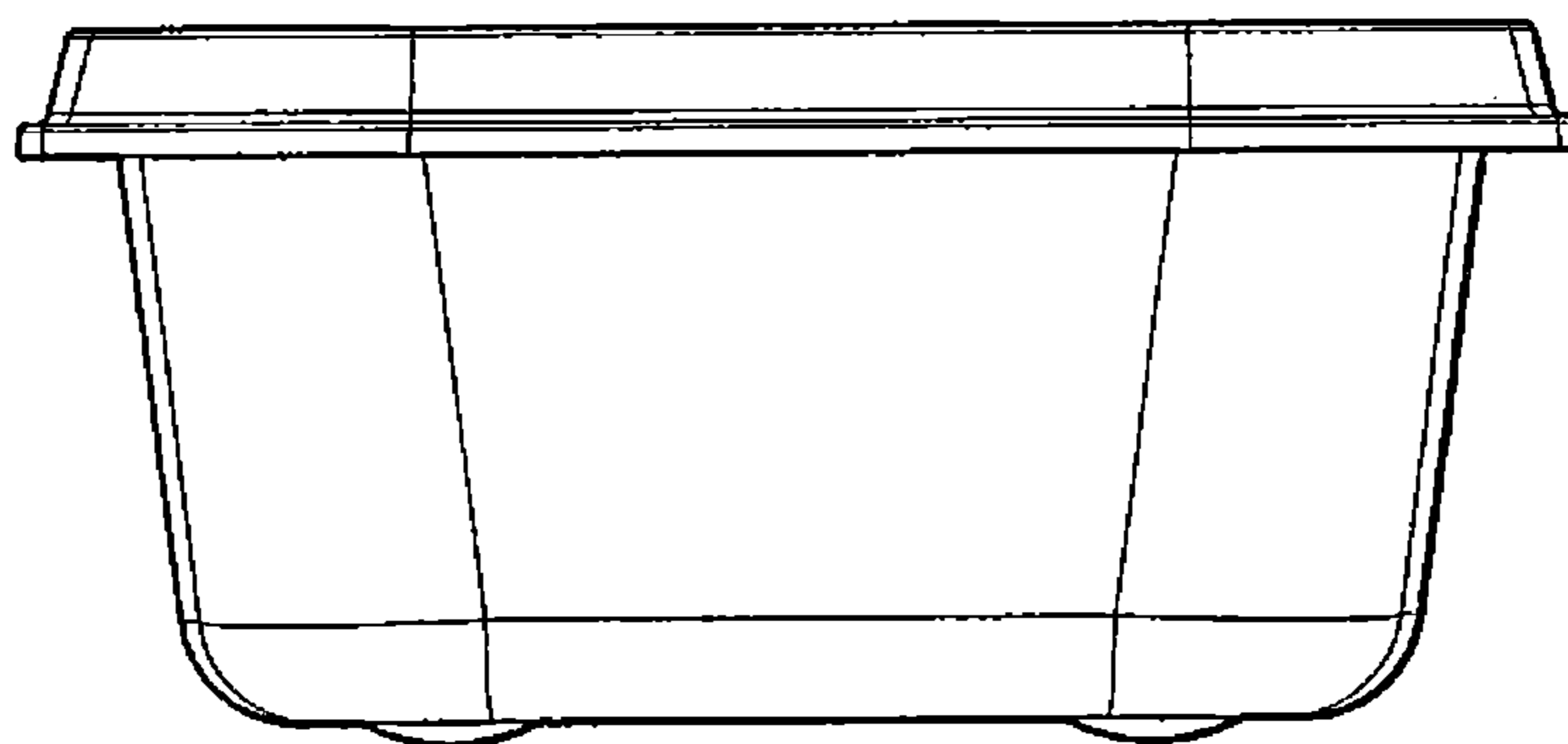

FIG. 8