



US00D717046S

(12) **United States Design Patent**
Ah-Young et al.

(10) **Patent No.:** **US D717,046 S**
(45) **Date of Patent:** **** Nov. 11, 2014**

(54) **PACKING BOX FOR REFRIGERATOR**

FOREIGN PATENT DOCUMENTS

(75) Inventors: **Kim Ah-Young**, Seoul (KR); **Chouljun Hwang**, Kyunggi-do (KR); **Jung Byungmin**, Kyunggi-do (KR); **Park Hyeungwook**, Kyunggi-do (KR)

JP 06156521 A * 6/1994 B65D 61/00
JP 2002053194 A * 2/2002 B65D 85/68

* cited by examiner

(73) Assignee: **Samsung Electronics Co., Ltd.**, Gyeonggi-do (KR)

Primary Examiner — Jennifer Rivard

(74) *Attorney, Agent, or Firm* — Harness, Dickey & Pierce

(**) Term: **14 Years**

(57) **CLAIM**

(21) Appl. No.: **29/426,038**

We claim the ornamental design for a packing box for refrigerator, as shown and described.

(22) Filed: **Jun. 29, 2012**

DESCRIPTION

(51) **LOC (10) Cl.** **03-01**

(52) **U.S. Cl.**
USPC **D3/272**

(58) **Field of Classification Search**
USPC D3/272, 276, 299; 206/524.6, 524.1;
220/6, 1.5, 666

See application file for complete search history.

(56) **References Cited**

U.S. PATENT DOCUMENTS

7,017,766	B2 *	3/2006	Hsu et al.	220/7
2008/0169285	A1 *	7/2008	Marazita et al.	220/7
2009/0114645	A1 *	5/2009	Zemer	220/1.5
2010/0147841	A1 *	6/2010	Tontarelli	220/6
2013/0020316	A1 *	1/2013	Hong	220/6
2013/0092685	A1 *	4/2013	Erm	220/6
2014/0042157	A1 *	2/2014	Giesbers	220/1.5

FIG. 1 is a front/right-side/top perspective view of a packing box for refrigerator showing our new design; FIG. 2 is a front-side elevational view thereof; FIG. 3 is a rear-side elevational view thereof; FIG. 4 is a left-side elevational view thereof; FIG. 5 is a right-side elevational view thereof; FIG. 6 is a top-side elevational view thereof; FIG. 7 is a bottom-side elevational view thereof.

FIG. 8 is a front perspective view of the design shown partially collapsed; and,

FIG. 9 is a front perspective view of the design shown fully collapsed.

The top and bottom portions of the packing box have been removed in FIGS. 8 and 9 for convenience of illustration.

1 Claim, 9 Drawing Sheets

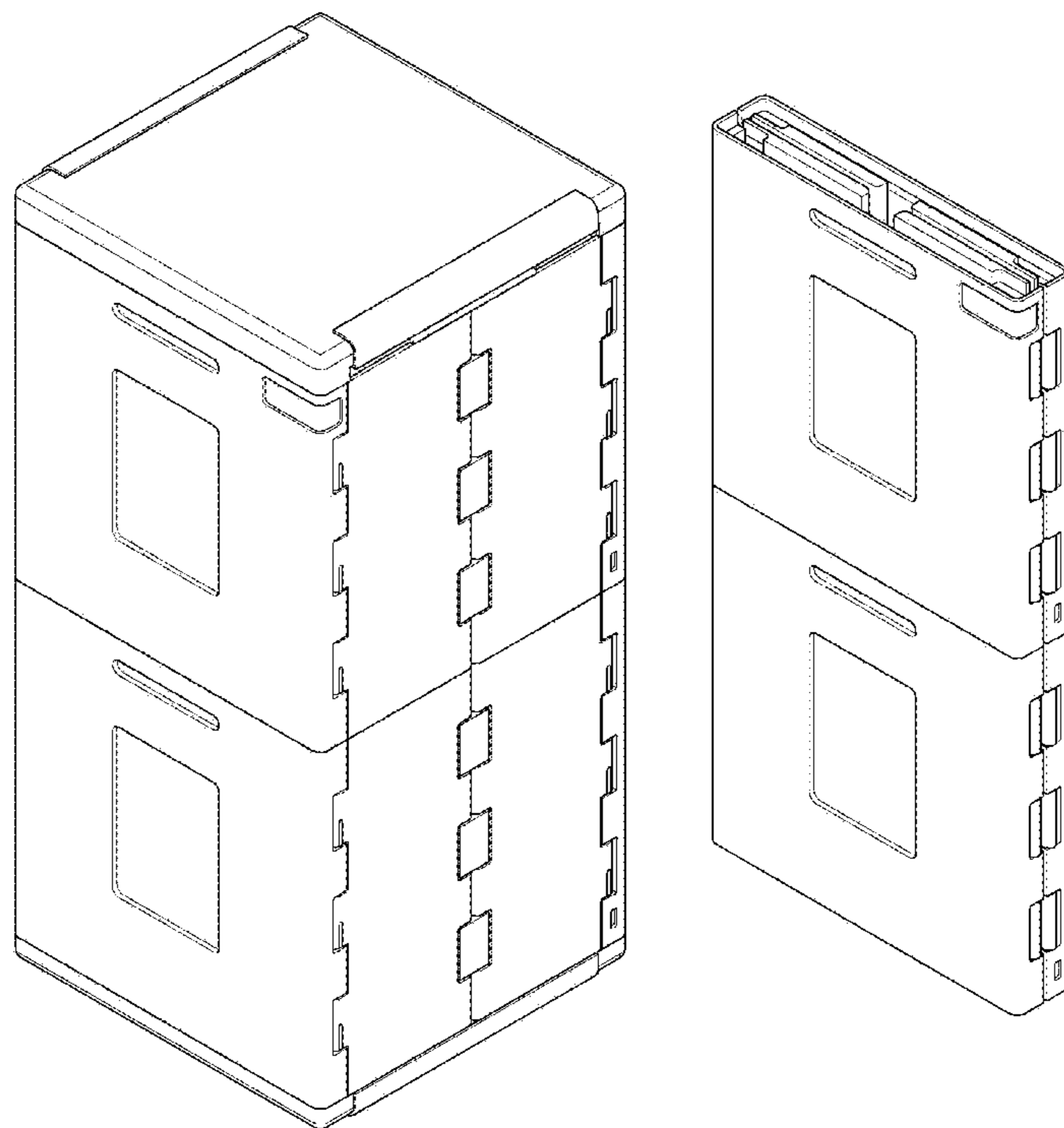

FIG. 1

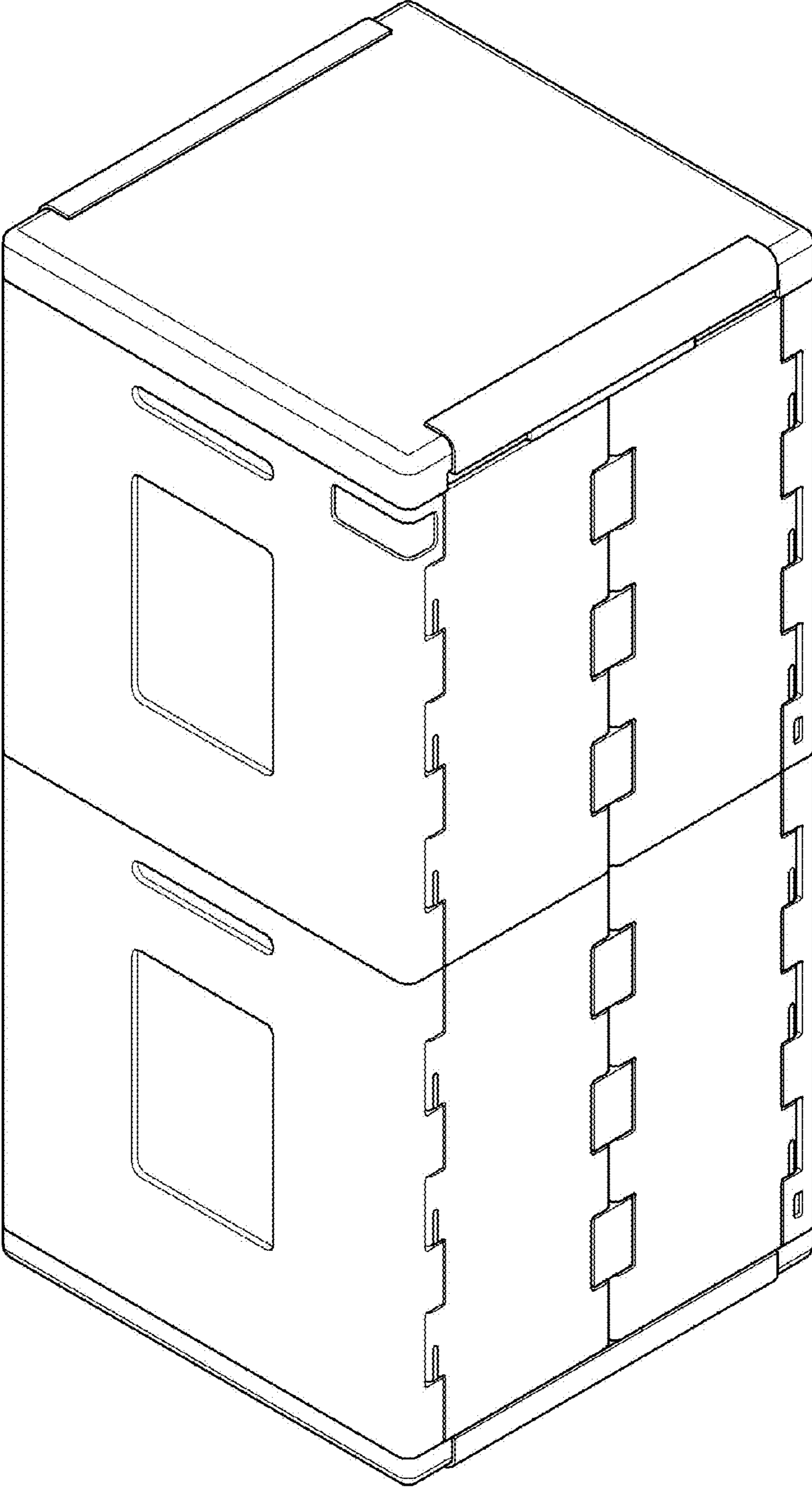

FIG. 2

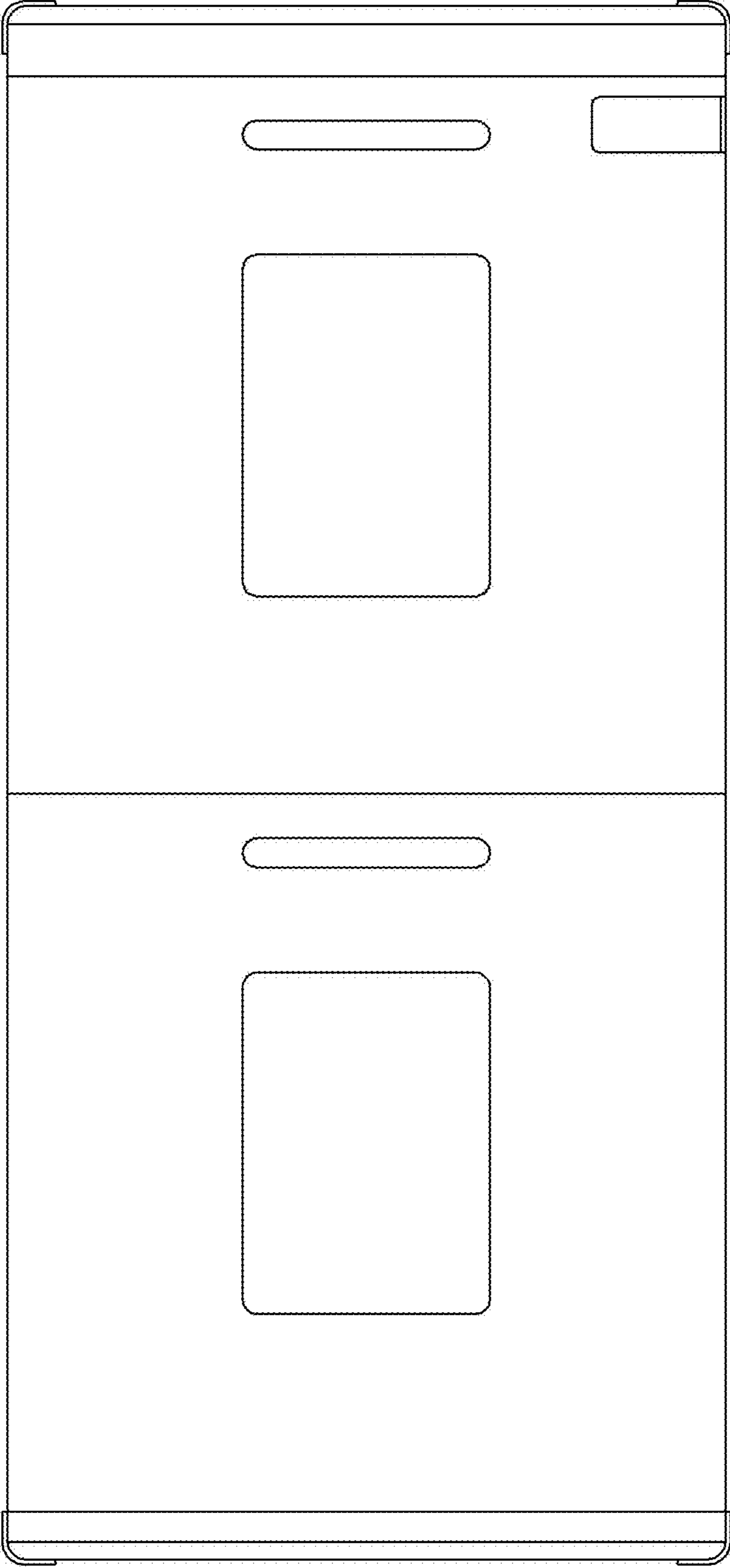

FIG. 3

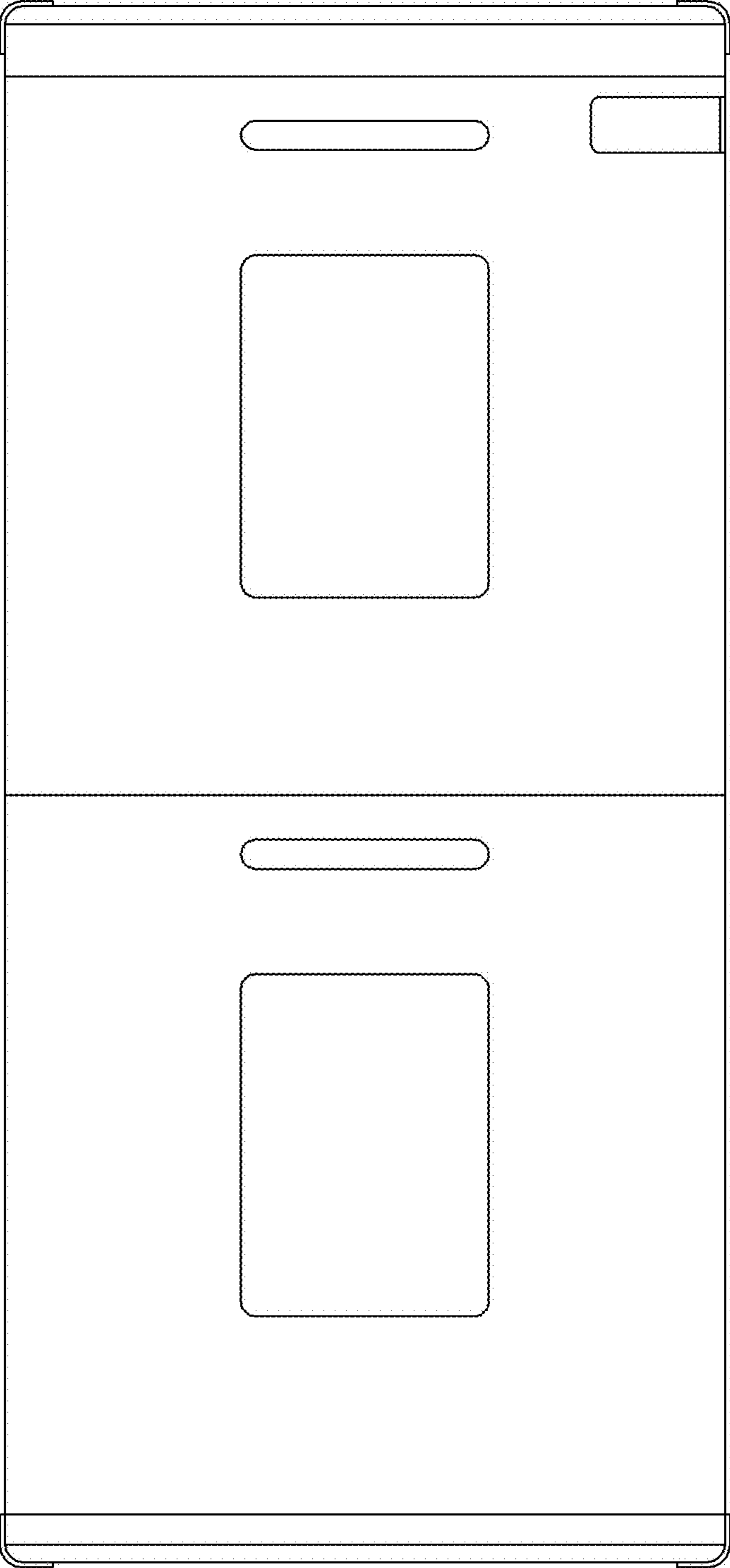

FIG. 4

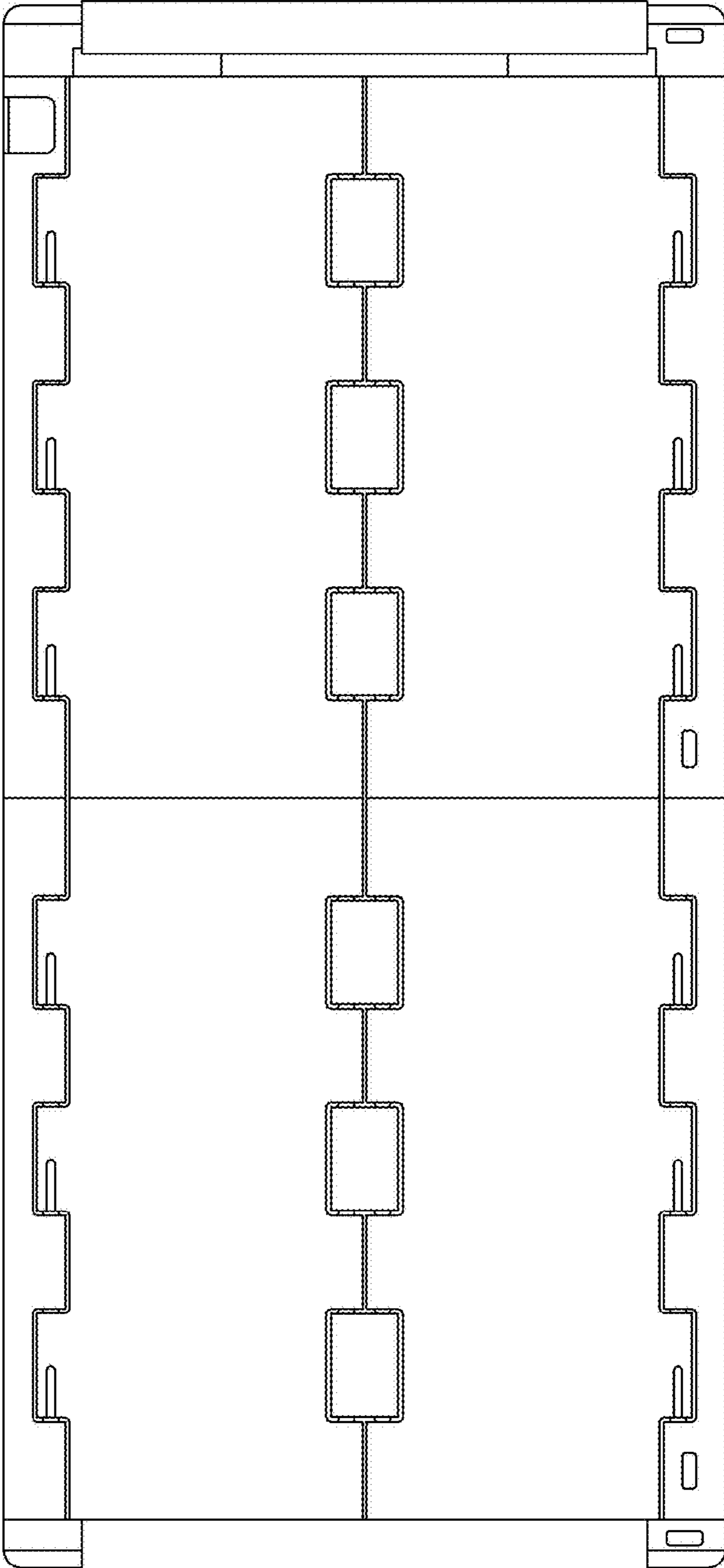

FIG. 5

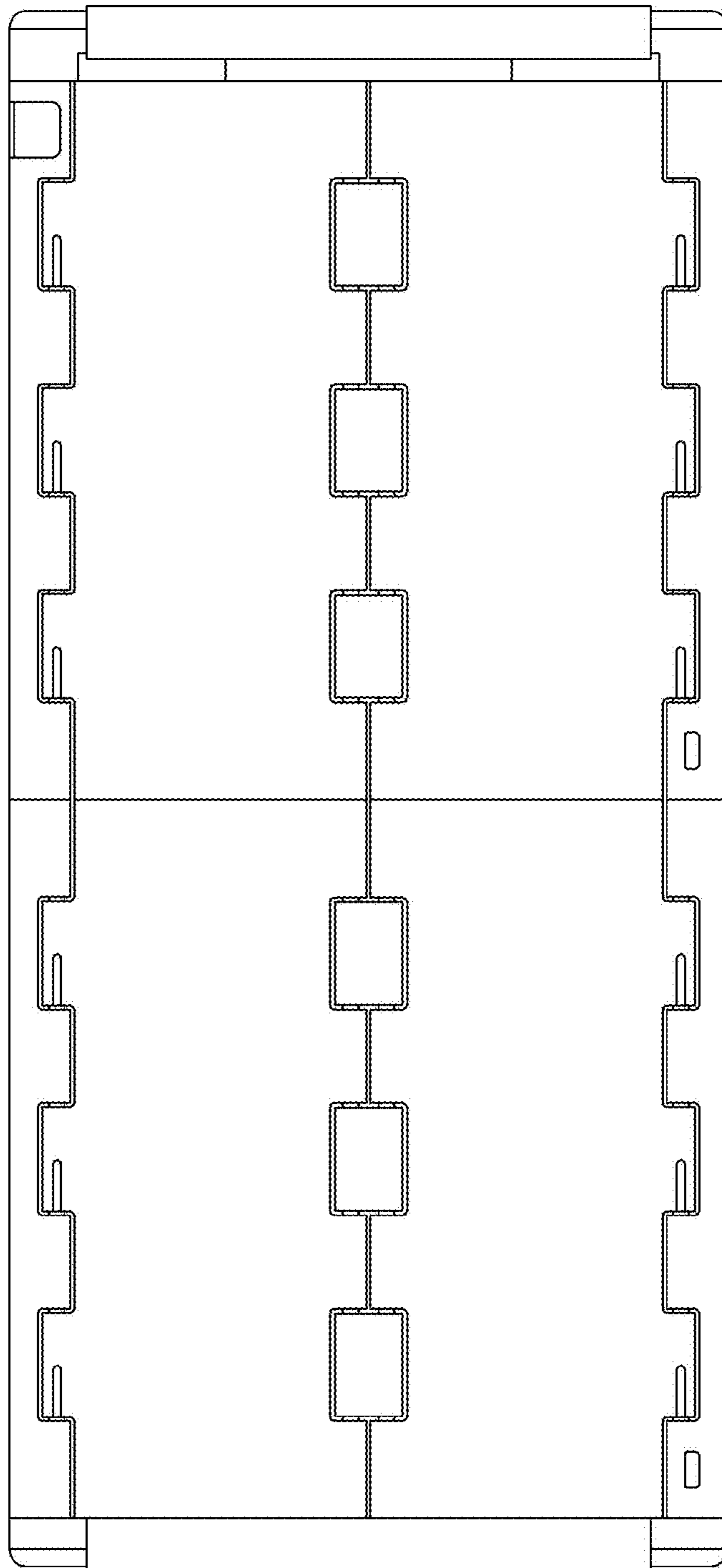

FIG. 6

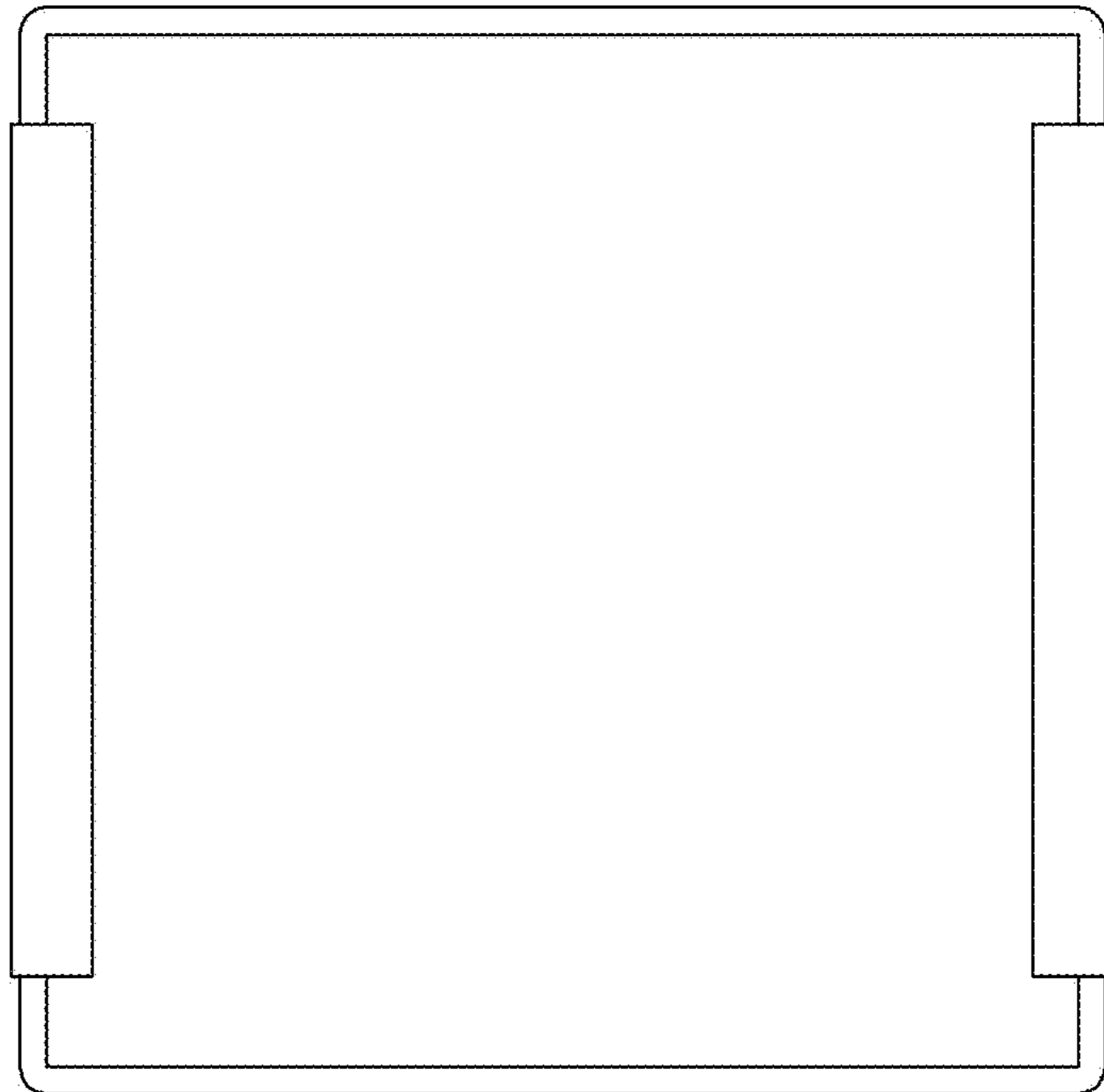

FIG. 7

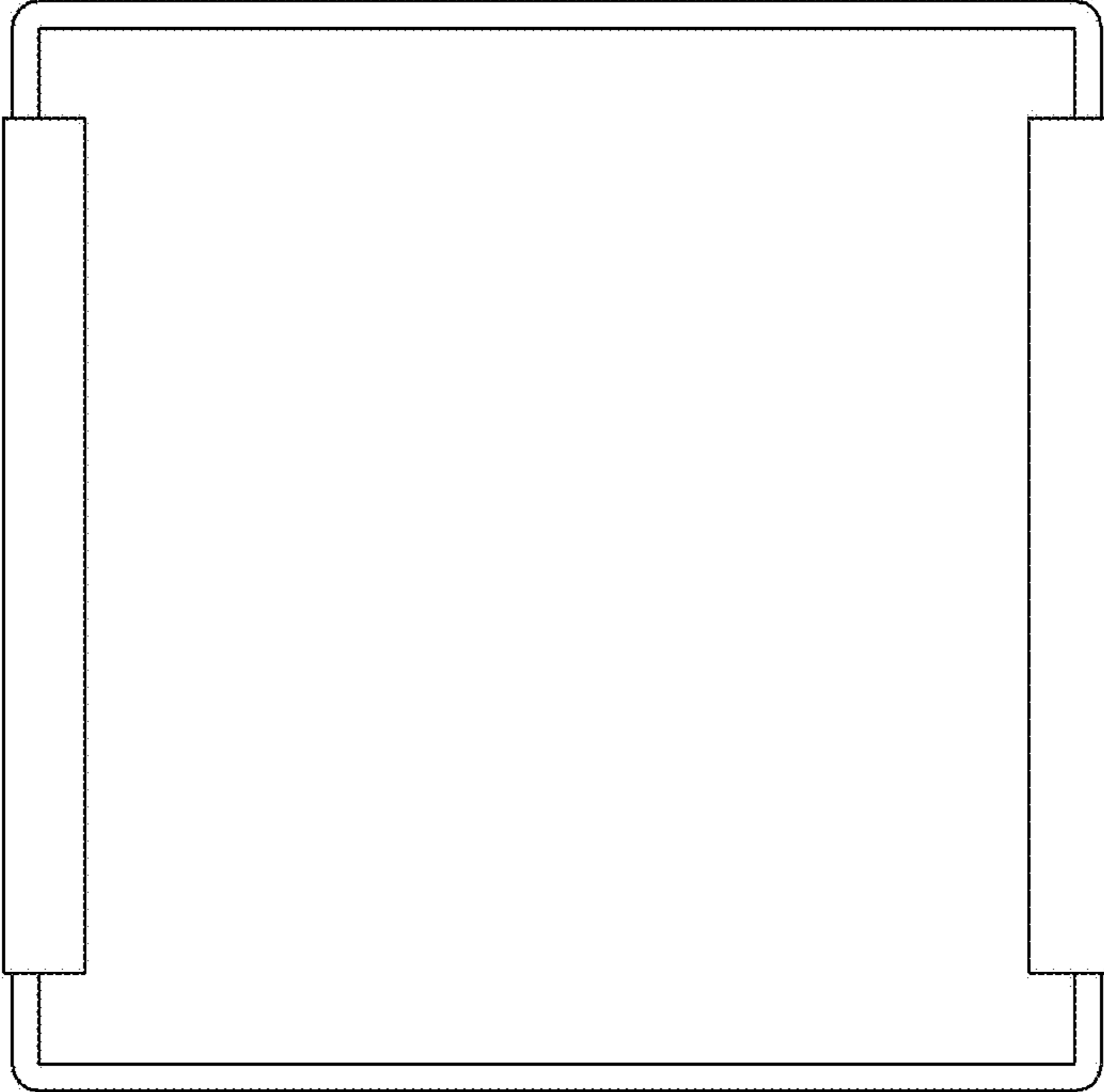

FIG. 8

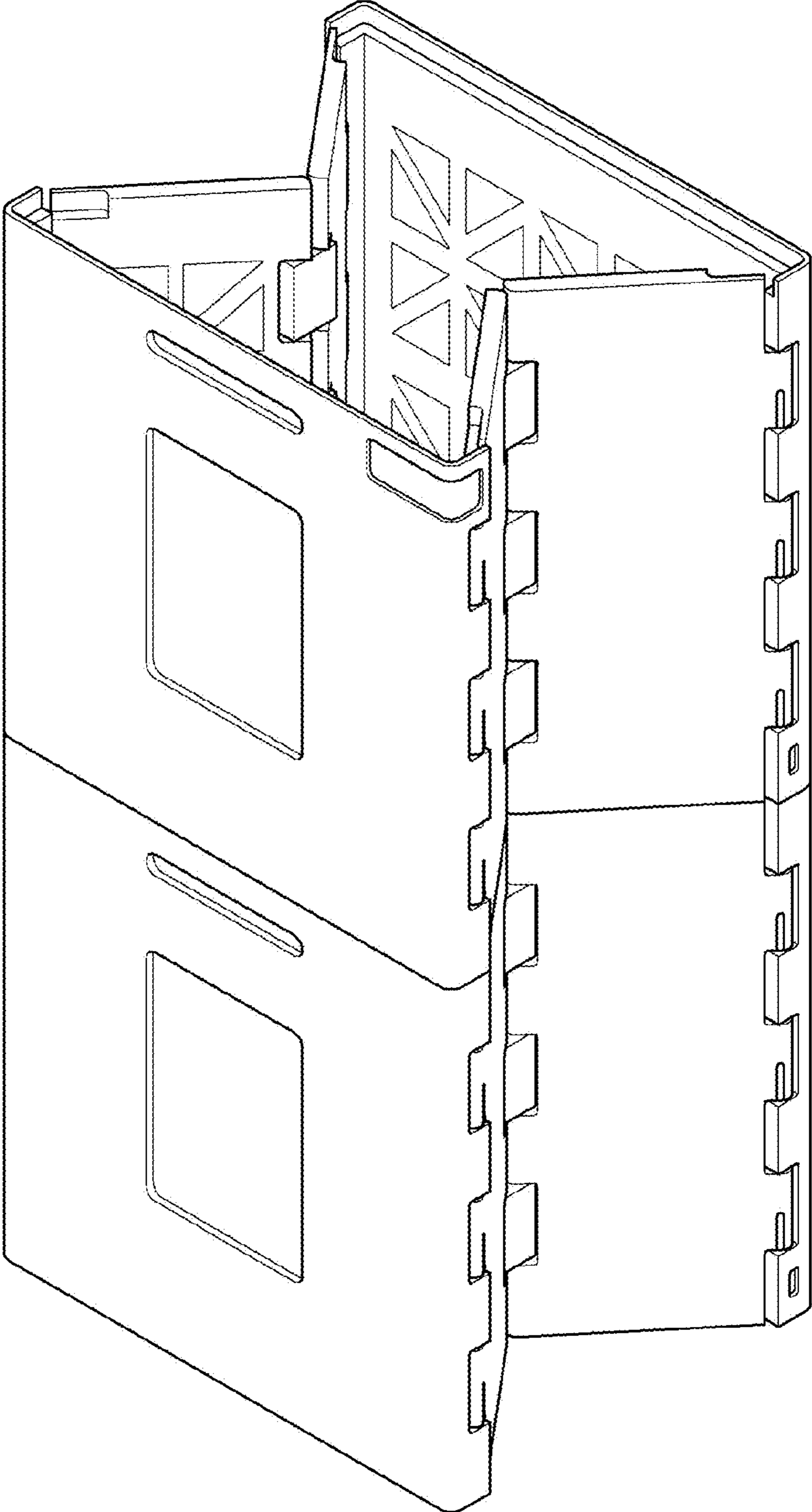

FIG. 9

