



US00D717000S

(12) **United States Design Patent**
Julemont

(10) **Patent No.:** **US D717,000 S**
(45) **Date of Patent:** **** Nov. 4, 2014**

- (54) **HAIR STYLIZING APPARATUS**
- (71) Applicant: **Babyliss Faco SPRL**, Wandre (BE)
- (72) Inventor: **Pierre L Julemont**, Soumagne (BE)
- (73) Assignee: **Conair Corporation**, Stamford, CT (US)
- (**) Term: **14 Years**
- (21) Appl. No.: **29/469,339**
- (22) Filed: **Oct. 9, 2013**

- (30) **Foreign Application Priority Data**
- Apr. 10, 2013 (EM) 002217927-0001
- (51) **LOC (10) Cl.** **28-03**
- (52) **U.S. Cl.**
USPC **D28/35**
- (58) **Field of Classification Search**
USPC D28/35, 7, 10; 219/222; 132/210, 211,
132/223-269, 271-272
See application file for complete search history.

- (56) **References Cited**
- U.S. PATENT DOCUMENTS
- 6,615,846 B1 * 9/2003 Leason et al. 132/212
- D491,310 S 6/2004 Glucksman et al.
- D502,288 S 2/2005 Longoria
- D502,568 S 3/2005 Longoria
- D515,738 S 2/2006 Grassi
- D537,982 S 3/2007 Kim

8,132,571 B1 *	3/2012	Jackson	132/211
D672,498 S	12/2012	Kim		
D696,456 S	12/2013	Julemont		
2003/0131867 A2 *	7/2003	Kennedy et al.	132/200
2013/0068245 A1 *	3/2013	De Benedictis et al.	132/237
2013/0125919 A1	5/2013	De Benedictis et al.		

* cited by examiner

Primary Examiner — Jennifer Rivard

(74) *Attorney, Agent, or Firm* — Carter, DeLuca, Farrell & Schmidt LLP

(57) **CLAIM**

The ornamental design for a hair stylizing apparatus, as shown and described.

DESCRIPTION

FIG. 1 is a first perspective view of the hair stylizing apparatus of the present invention;
 FIG. 2 is a second perspective view of the hair stylizing apparatus;
 FIG. 3 is a first side elevation view of the hair stylizing apparatus;
 FIG. 4 is a second side elevation view of the hair stylizing apparatus;
 FIG. 5 is a top plan view of the hair stylizing apparatus;
 FIG. 6 is a bottom plan view of the hair stylizing apparatus;
 and,
 FIG. 7 is an enlarged front view of the hair stylizing apparatus.
 The broken lines shown in the drawings illustrate a portion of the hair stylizing apparatus and form no part of the claimed design.

1 Claim, 7 Drawing Sheets

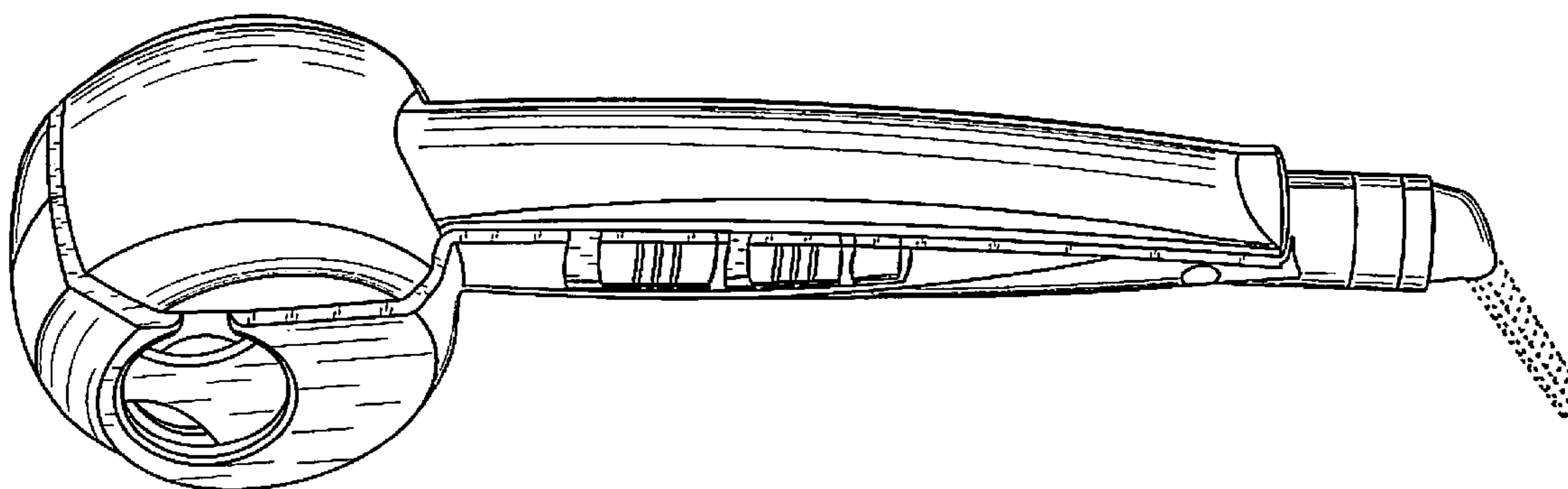

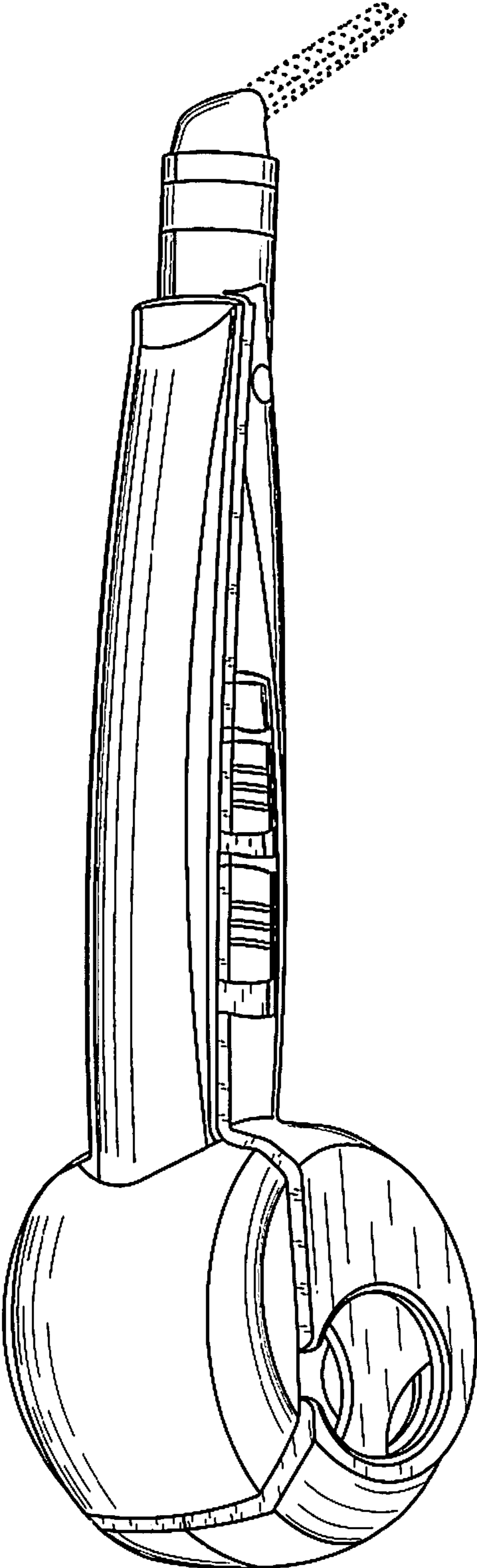

FIG. 1

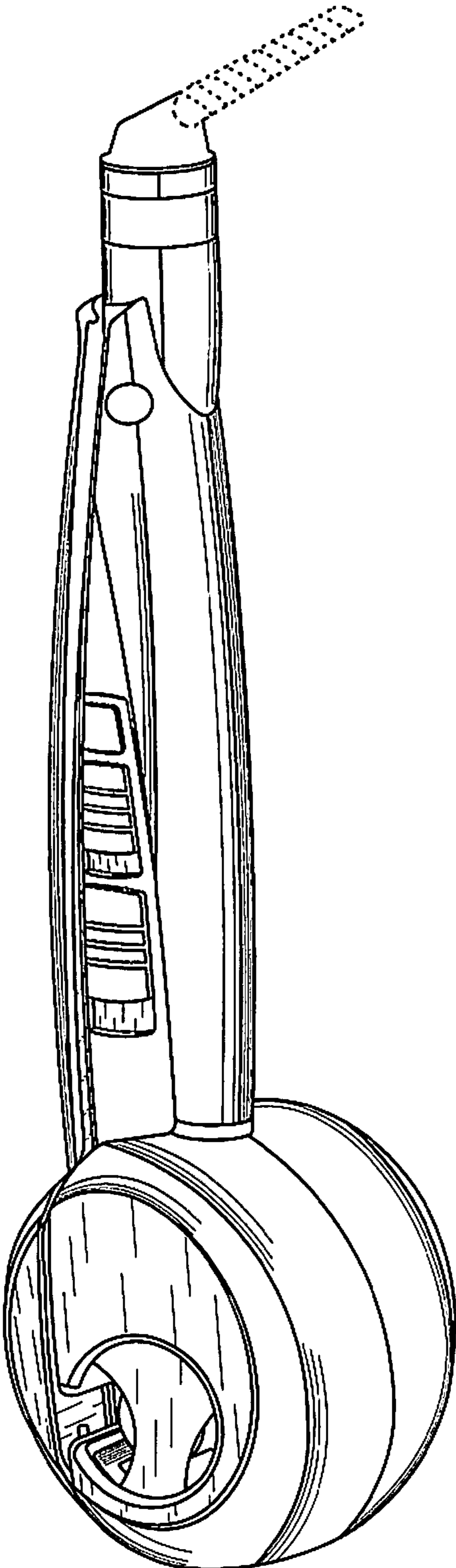

FIG. 2

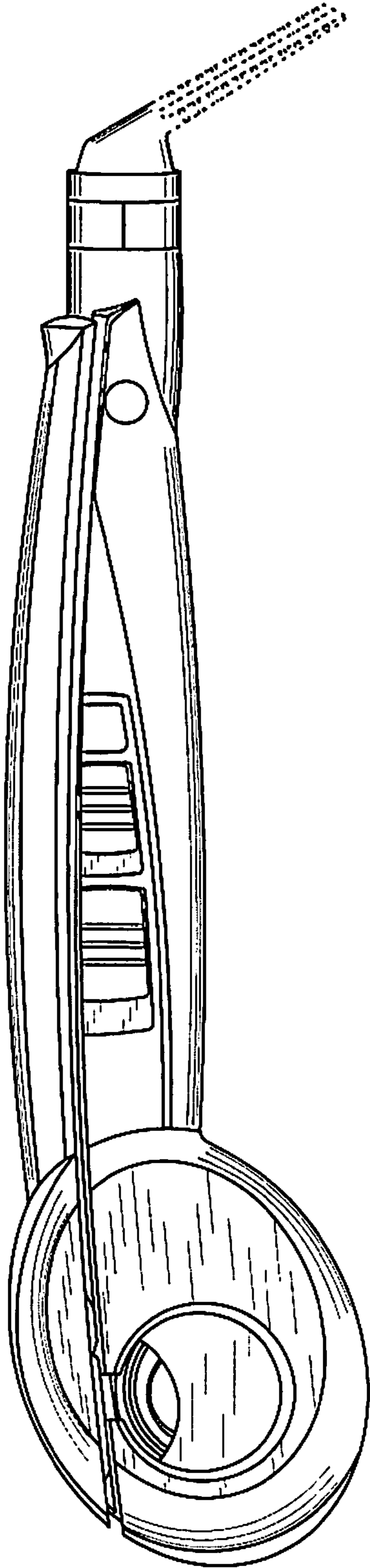

FIG. 3

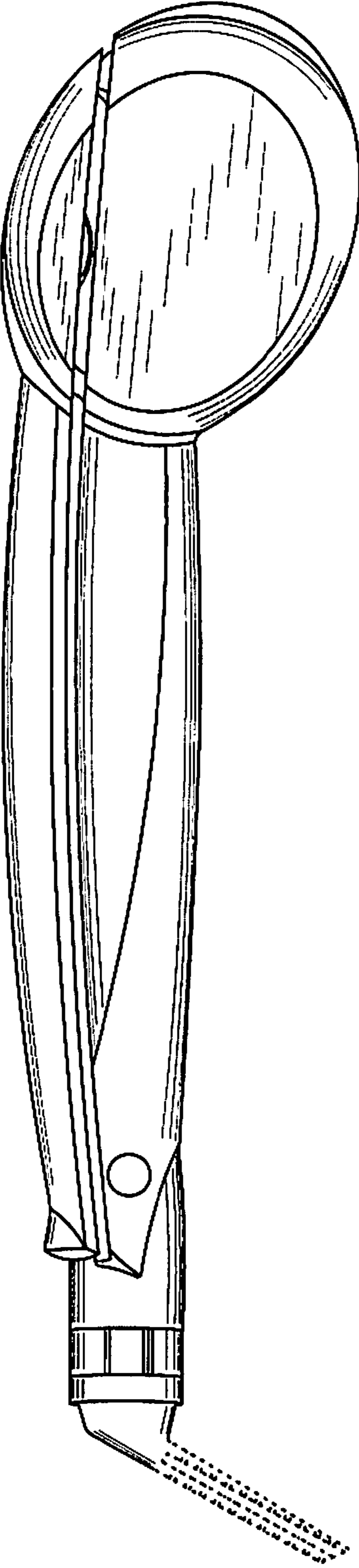

FIG. 4

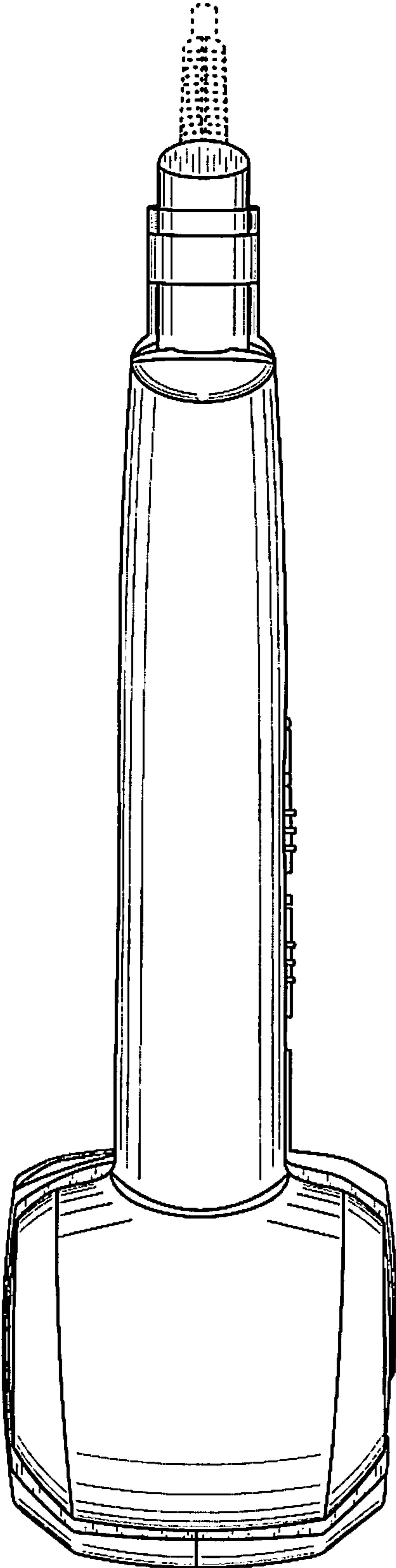

FIG. 5

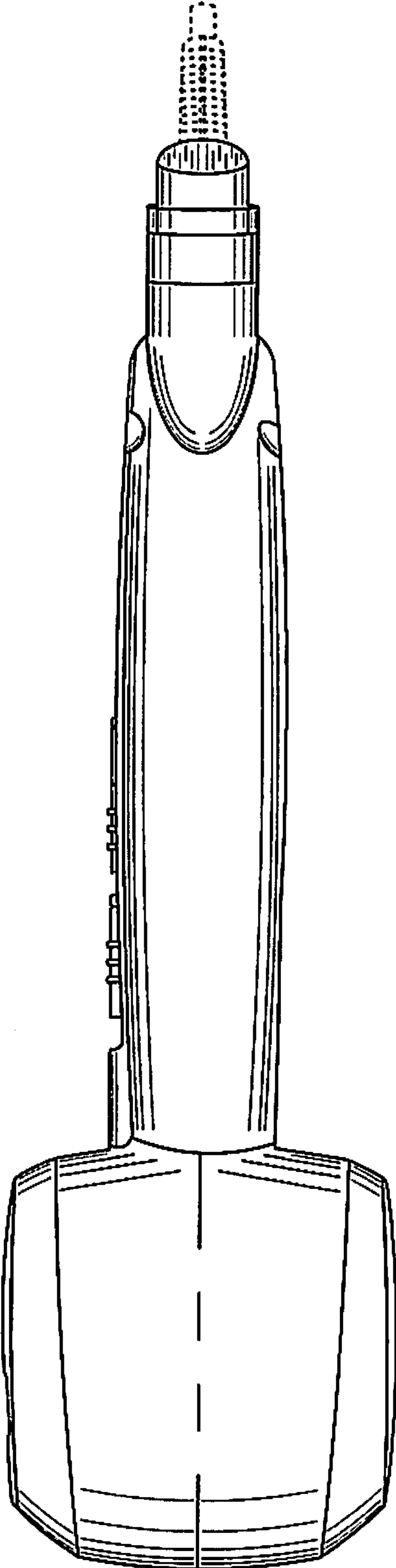

FIG. 6

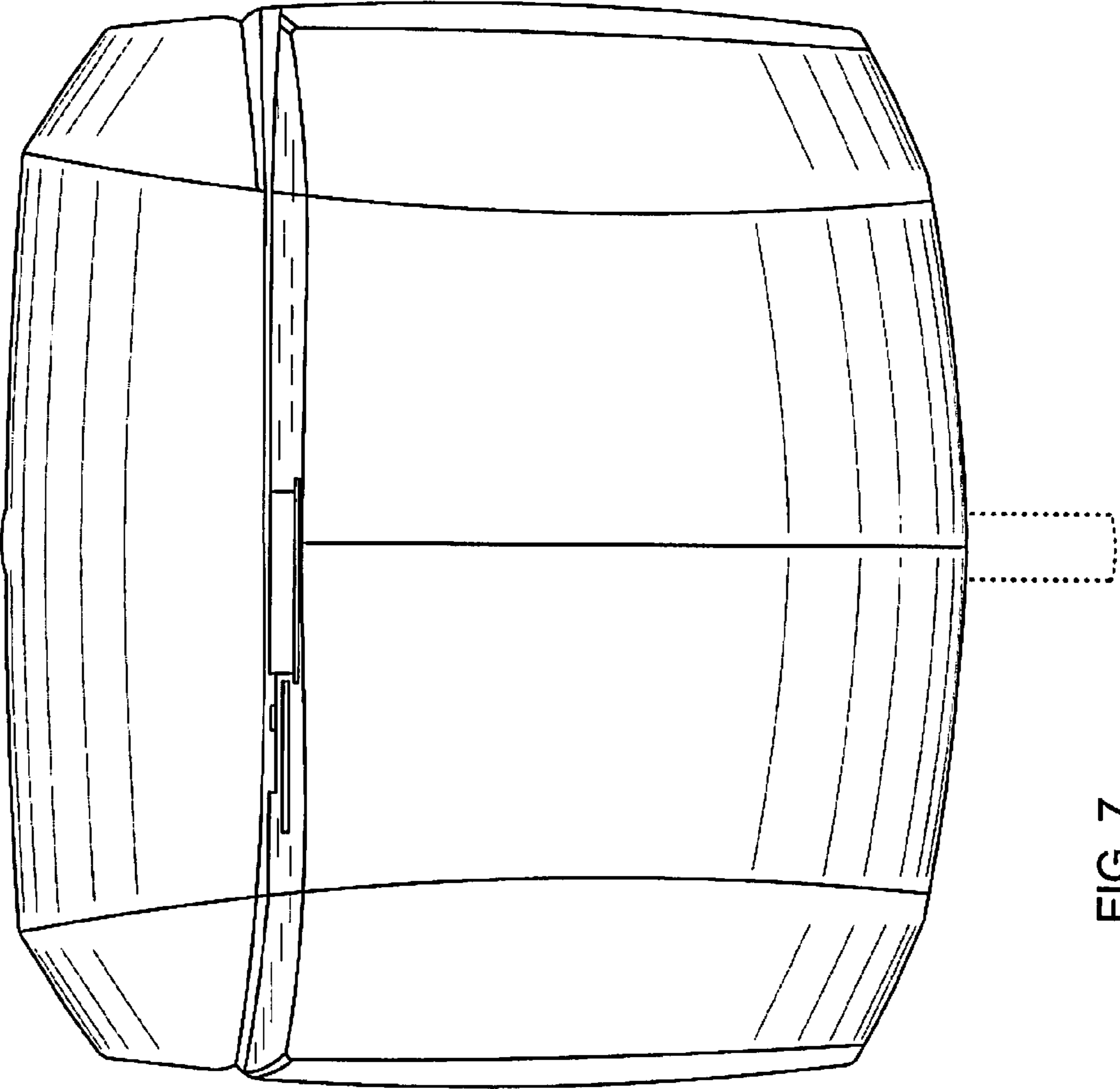

FIG. 7