



US00D716936S

(12) **United States Design Patent**
Jensen et al.

(10) **Patent No.:** **US D716,936 S**

(45) **Date of Patent:** **** Nov. 4, 2014**

(54) **INHALER**

(75) Inventors: **Rasmus Løgstrup Jensen**, Aarhus
(DK); **Thomas Aagaard Jensen**, Aarhus
(DK)

(73) Assignee: **AstraZeneca AB**, Sodertalje (SE)

(**) Term: **14 Years**

(21) Appl. No.: **29/415,300**

(22) Filed: **Mar. 9, 2012**

(30) **Foreign Application Priority Data**

Nov. 14, 2011	(EP)	001917204-0001
Nov. 14, 2011	(EP)	001917204-0002
Nov. 14, 2011	(EP)	001917204-0003
Nov. 14, 2011	(EP)	001917204-0004
Nov. 14, 2011	(EP)	001917204-0005
Nov. 14, 2011	(EP)	001917204-0006
Nov. 14, 2011	(EP)	001917204-0007

(51) **LOC (10) Cl.** **29-02**

(52) **U.S. Cl.**
USPC **D24/110**

(58) **Field of Classification Search**
CPC A61M 15/0026; A61M 11/08
USPC D24/110, 110.5, 164; D9/682, 686,
D9/687, 694; 128/200.14, 200.21, 200.23,
128/203.15, 203.21, 203.23
See application file for complete search history.

(56) **References Cited**

U.S. PATENT DOCUMENTS

D348,929	S	*	7/1994	Paton	D24/110
D412,744	S	*	8/1999	Braithwaite	D24/110
D439,656	S	*	3/2001	Andersson et al.	D24/110
D449,882	S	*	10/2001	Christrup et al.	D24/110
D509,898	S	*	9/2005	Bunce et al.	D24/110
D582,544	S	*	12/2008	Meziere	D24/110
D585,541	S	*	1/2009	Petersen	D24/110
7,520,278	B2	*	4/2009	Crowder et al.	128/203.15
D598,536	S	*	8/2009	Parkes	D24/110

D620,588	S	*	7/2010	Nielsen	D24/110
2003/0192535	A1	*	10/2003	Christrup et al.	128/200.23
2009/0084379	A1	*	4/2009	Goeckner et al.	128/203.15

* cited by examiner

Primary Examiner — Ian Simmons

Assistant Examiner — Richelle Shelton

(74) *Attorney, Agent, or Firm* — James P. Kastenmayer

(57) **CLAIM**

The ornamental design for an inhaler, as shown and described.

DESCRIPTION

The patent or application file contains at least one drawing executed in color. Copies of this patent or patent application publication with color drawing(s) will be provided by the Office upon request and payment of the necessary fee.

FIG. 1 is a perspective view of an inhaler with a closed mouthpiece showing the first embodiment of our new design;

FIG. 2 is a front view of the inhaler of FIG. 1;

FIG. 3 is a rear view of the inhaler of FIG. 1;

FIG. 4 is a first side view of the inhaler of FIG. 1;

FIG. 5 is a second side view of the inhaler of FIG. 1;

FIG. 6 is a top plan view of the inhaler of FIG. 1;

FIG. 7 is a bottom plan view of the inhaler of FIG. 1;

FIG. 8 is a perspective view of the inhaler of FIG. 1 in an open-mouthpiece configuration before a dose is dispensed;

FIG. 9 is a front view of the inhaler of FIG. 8;

FIG. 10 is a rear view of the inhaler of FIG. 8;

FIG. 11 is a first side view of the inhaler of FIG. 8;

FIG. 12 is a second side view of the inhaler of FIG. 8;

FIG. 13 is a top plan view of the inhaler of FIG. 8;

FIG. 14 is a bottom plan view of the inhaler of FIG. 8;

FIG. 15 is a perspective view of the inhaler of FIG. 1 in an open-mouthpiece configuration after a dose is dispensed;

FIG. 16 is a front view of the inhaler of FIG. 15;

FIG. 17 is a rear view of the inhaler of FIG. 15;

FIG. 18 is a first side view of the inhaler of FIG. 15;

FIG. 19 is a second side view of the inhaler of FIG. 15;

FIG. 20 is a top plan view of the inhaler of FIG. 15;

FIG. 21 is a bottom plan view of the inhaler of FIG. 15;

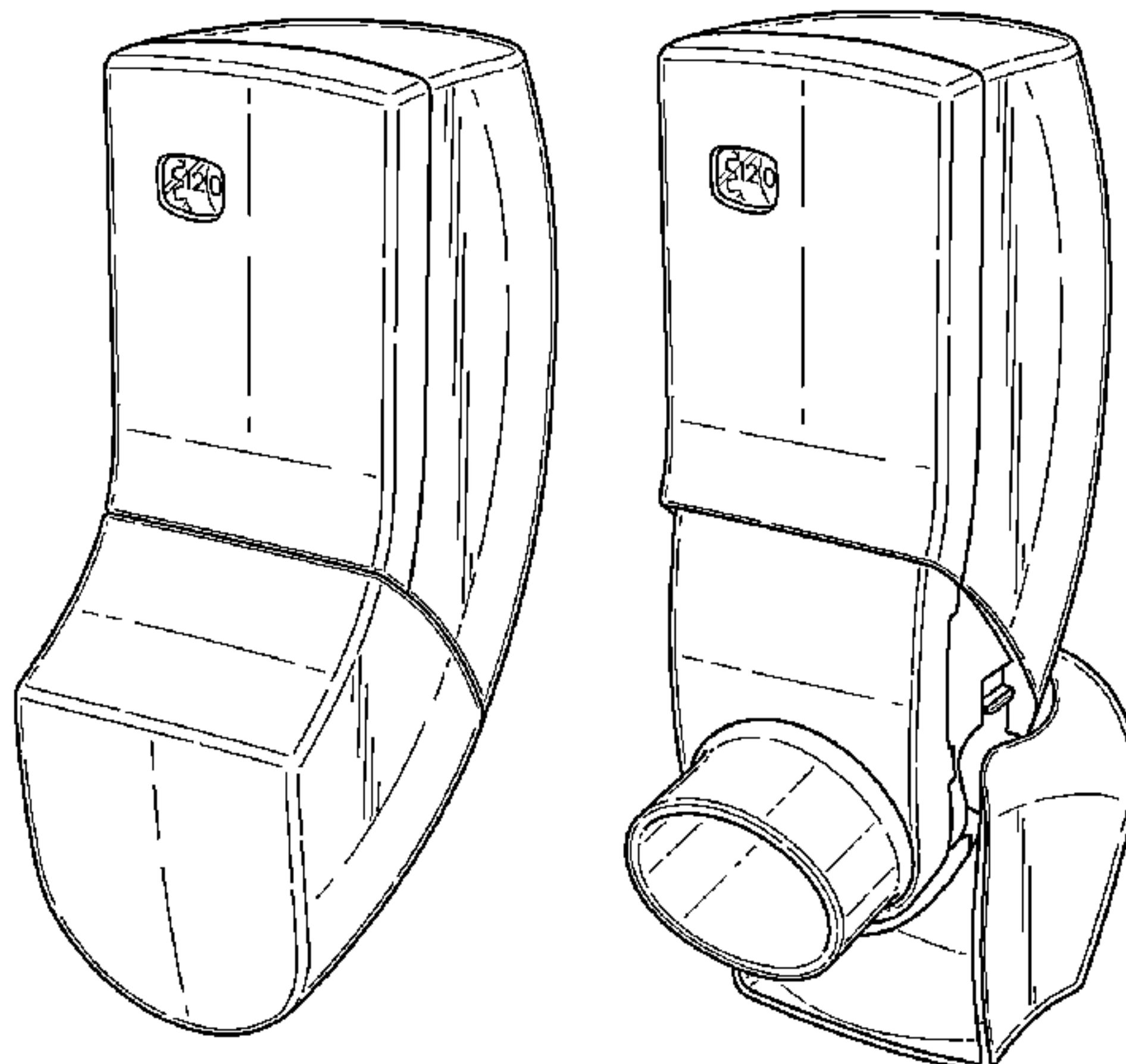

FIG. 22 is a perspective view of an inhaler with a closed mouthpiece showing the second embodiment of our new design;

FIG. 23 is a front view of the inhaler of FIG. 22;

FIG. 24 is a rear view of the inhaler of FIG. 22;

FIG. 25 is a first side view of the inhaler of FIG. 22;

FIG. 27 is a second side view of the inhaler of FIG. 22;

FIG. 27 is a top plan view of the inhaler of FIG. 22;

FIG. 28 is a bottom plan view of the inhaler of FIG. 22; and

FIG. 29 is a perspective view of the inhaler of FIG. 22 in an open-mouthpiece configuration before a dose is dispensed;

FIG. 30 is a front view of the inhaler of FIG. 29;

FIG. 31 is a rear view of the inhaler of FIG. 29;

FIG. 32 is a first side view of the inhaler of FIG. 29;

FIG. 33 is a second side view of the inhaler of FIG. 29;

FIG. 34 is a top plan view of the inhaler of FIG. 29; and,

FIG. 35 is a bottom plan view of the inhaler of FIG. 29.

1 Claim, 10 Drawing Sheets
(4 of 10 Drawing Sheet(s) Filed in Color)

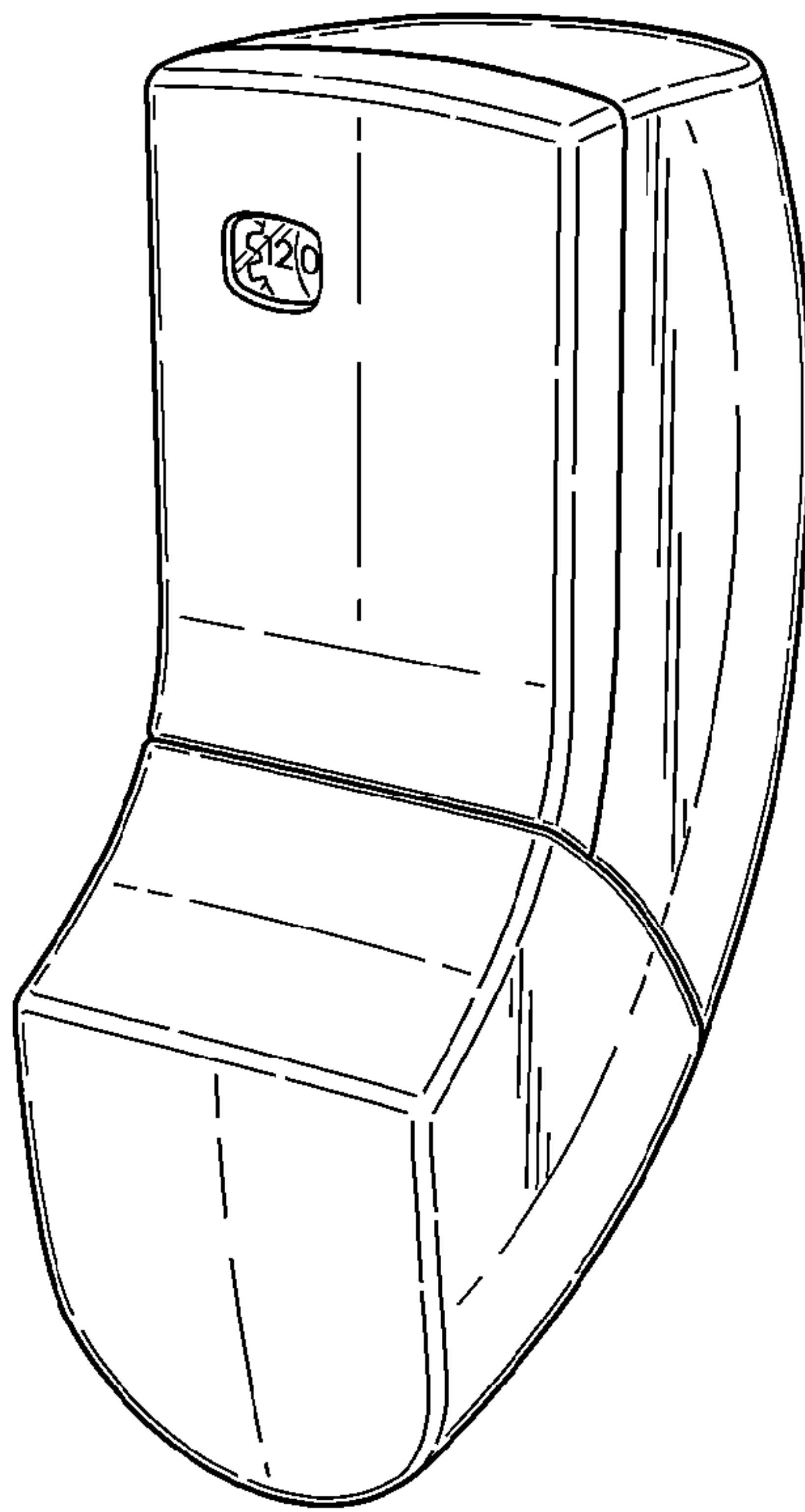

Fig. 1

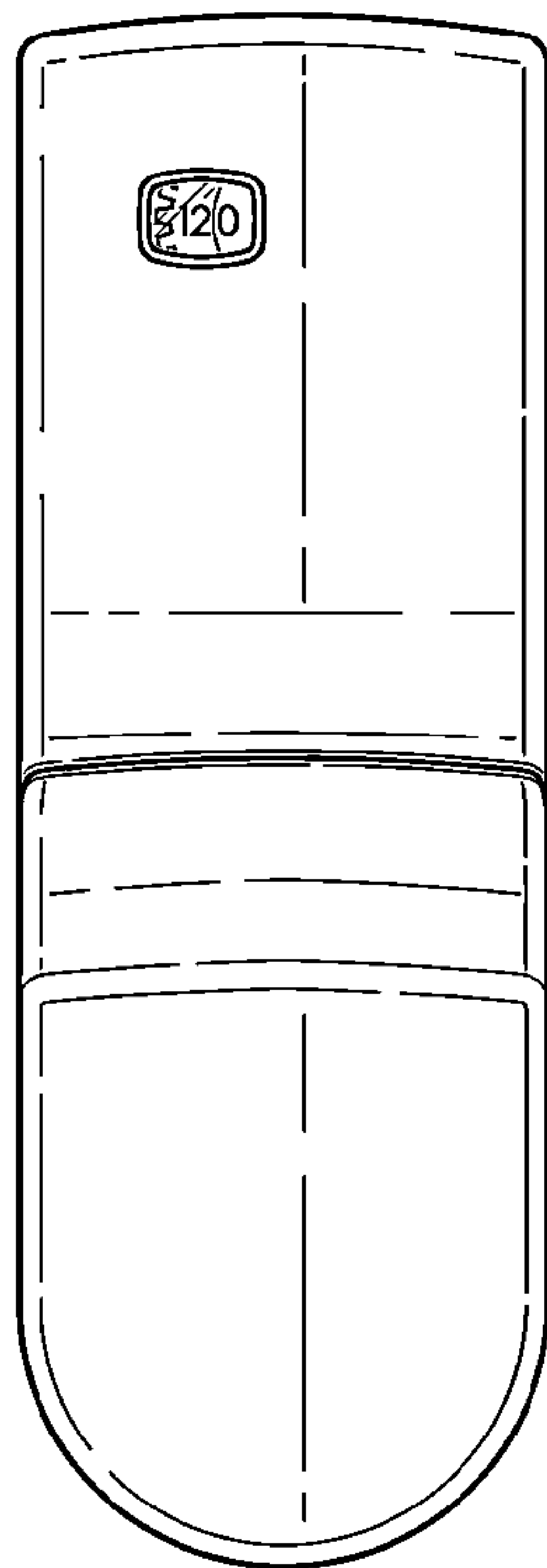

Fig. 2

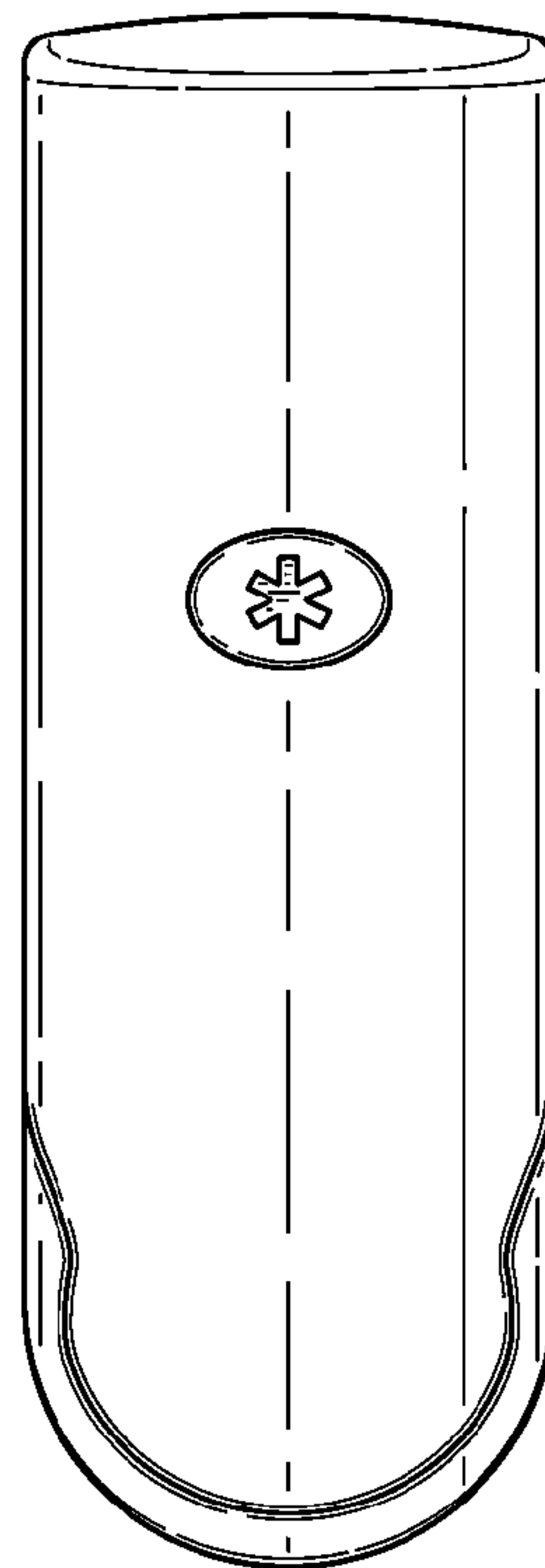

Fig. 3

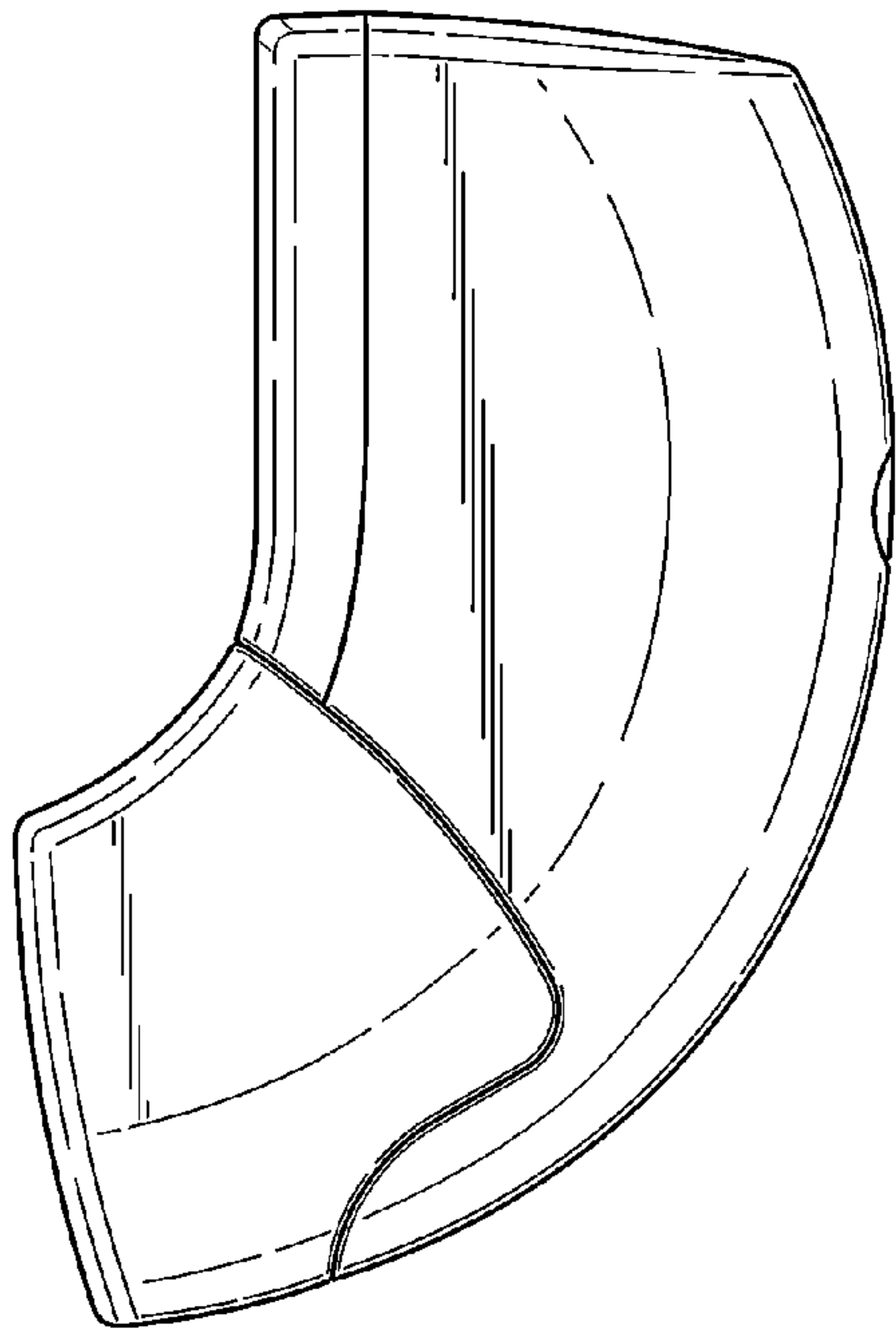

Fig. 4

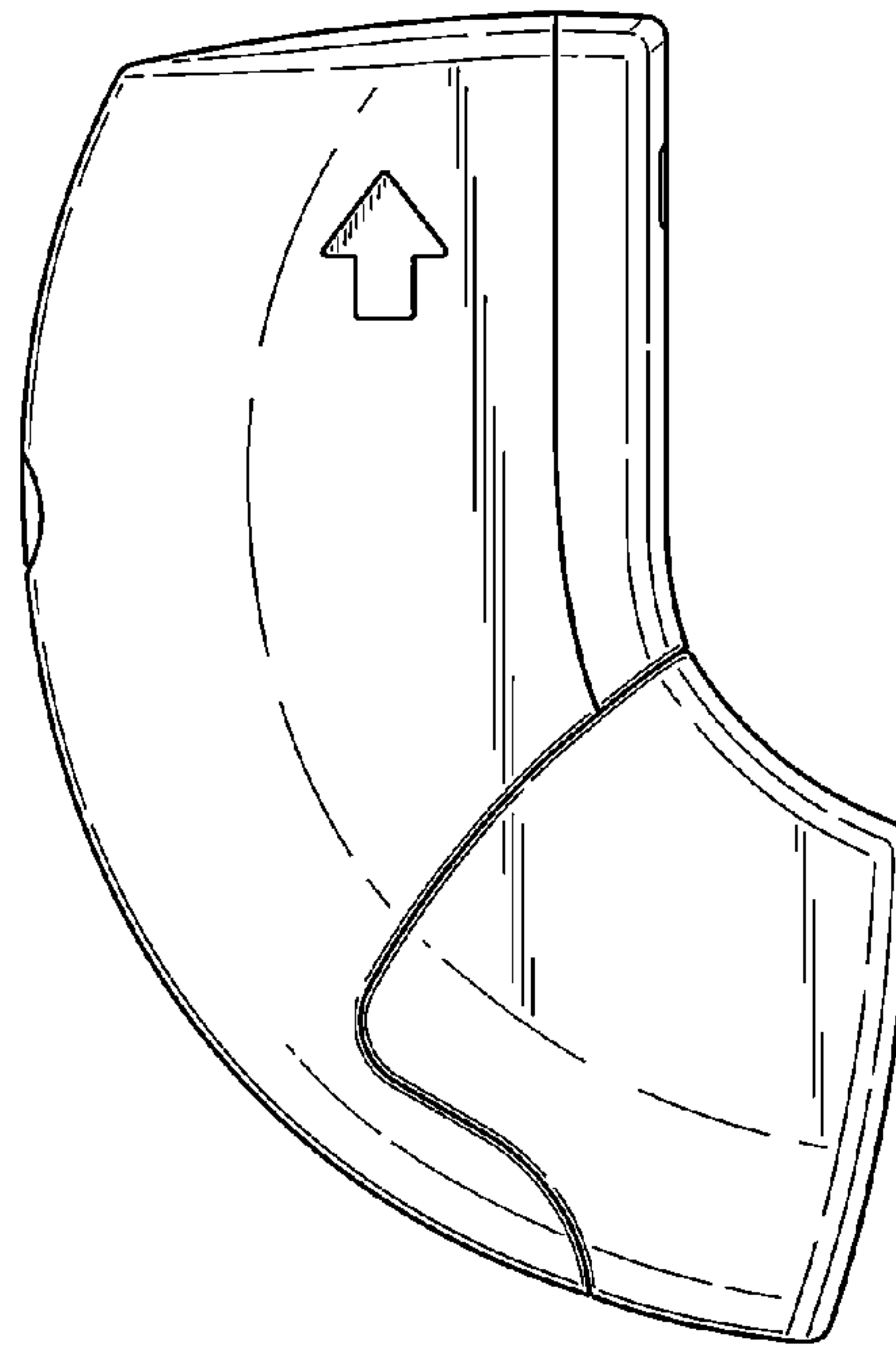

Fig. 5

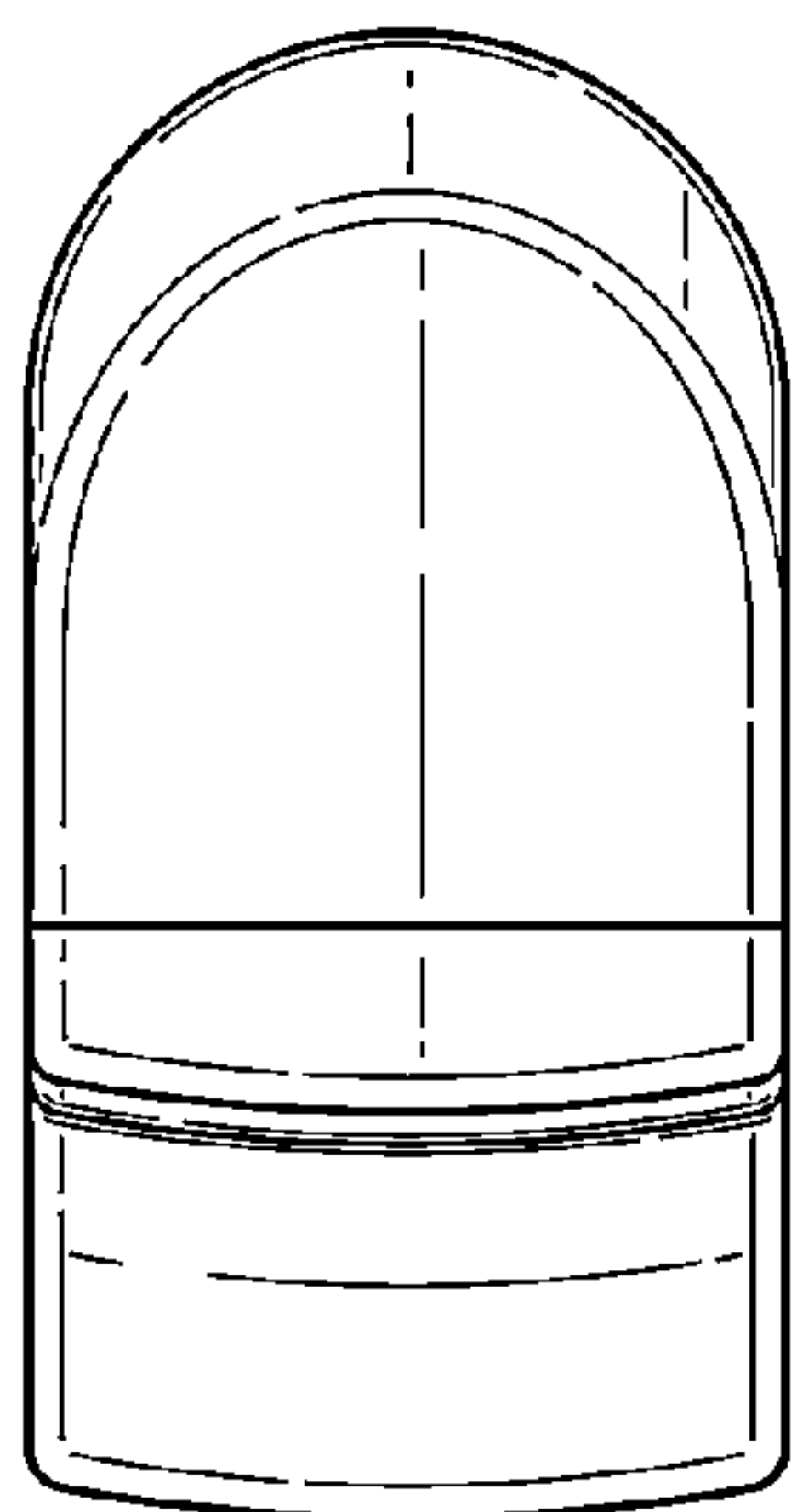

Fig. 6

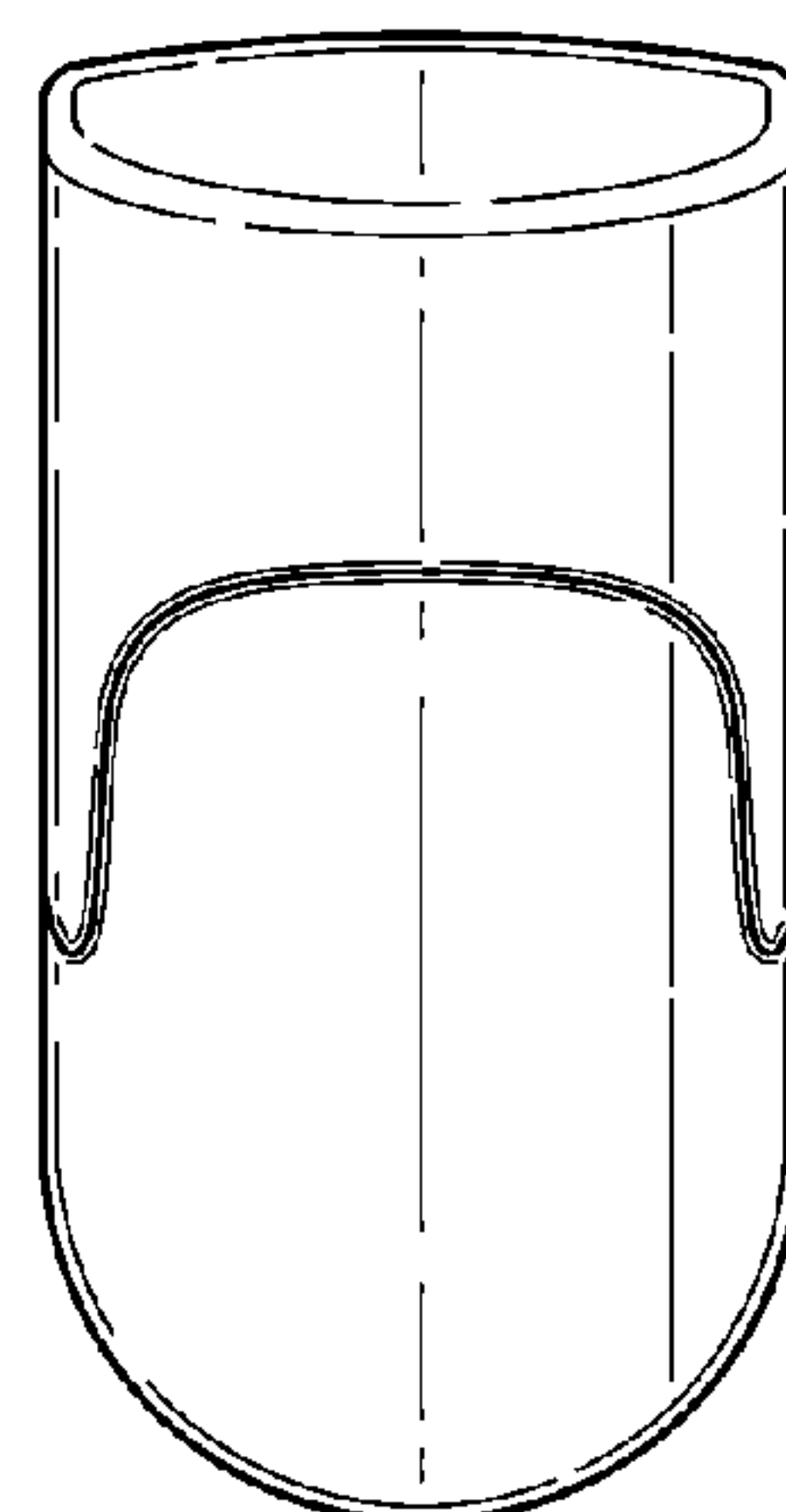

Fig. 7

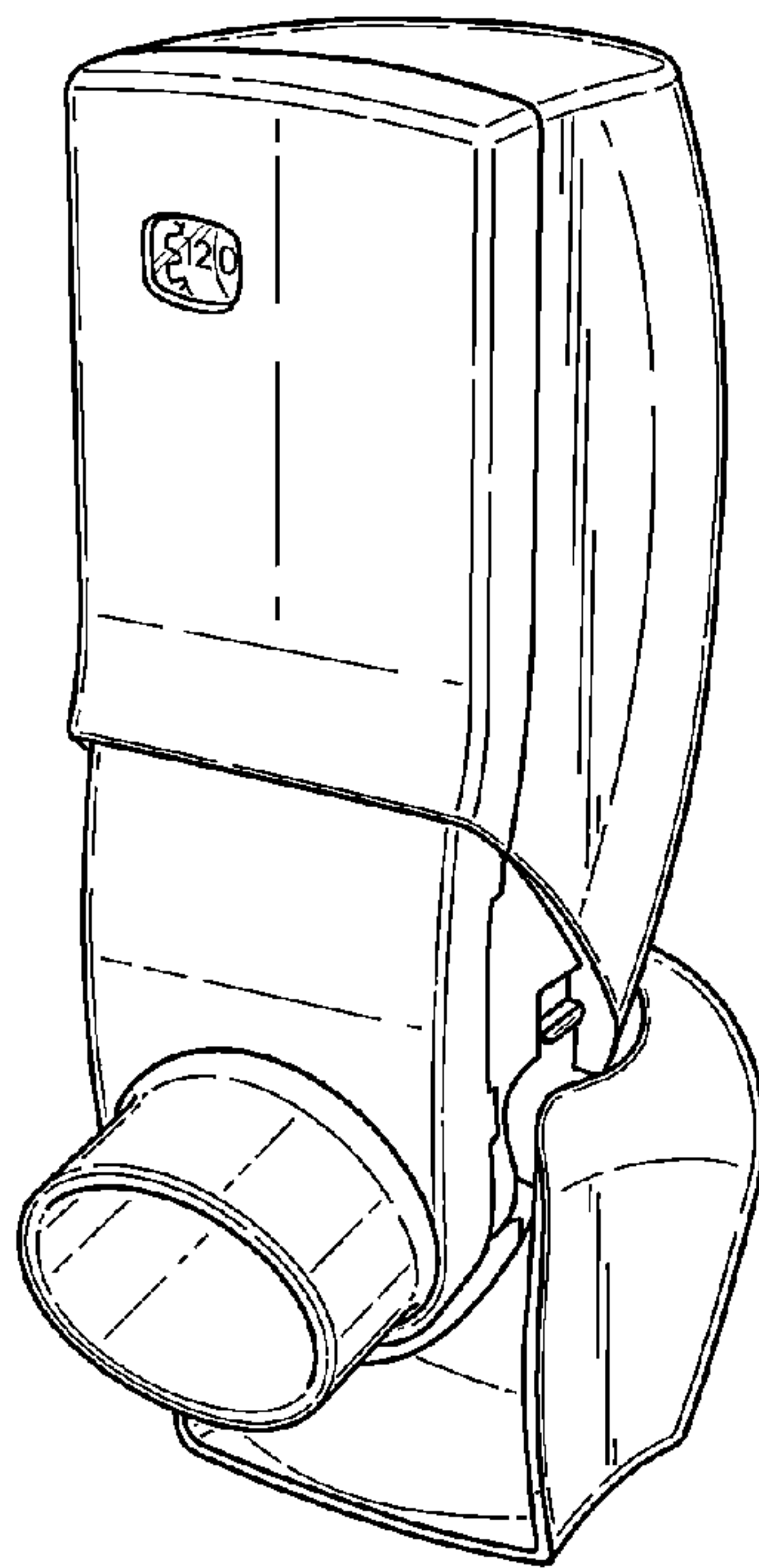

Fig. 8

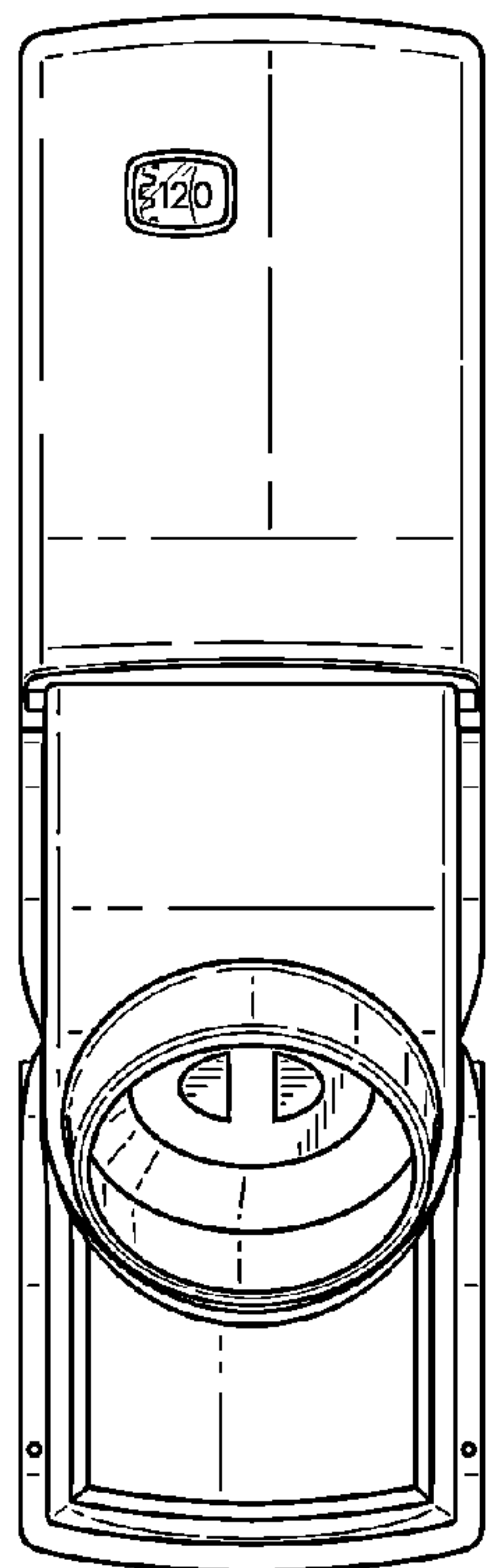

Fig. 9

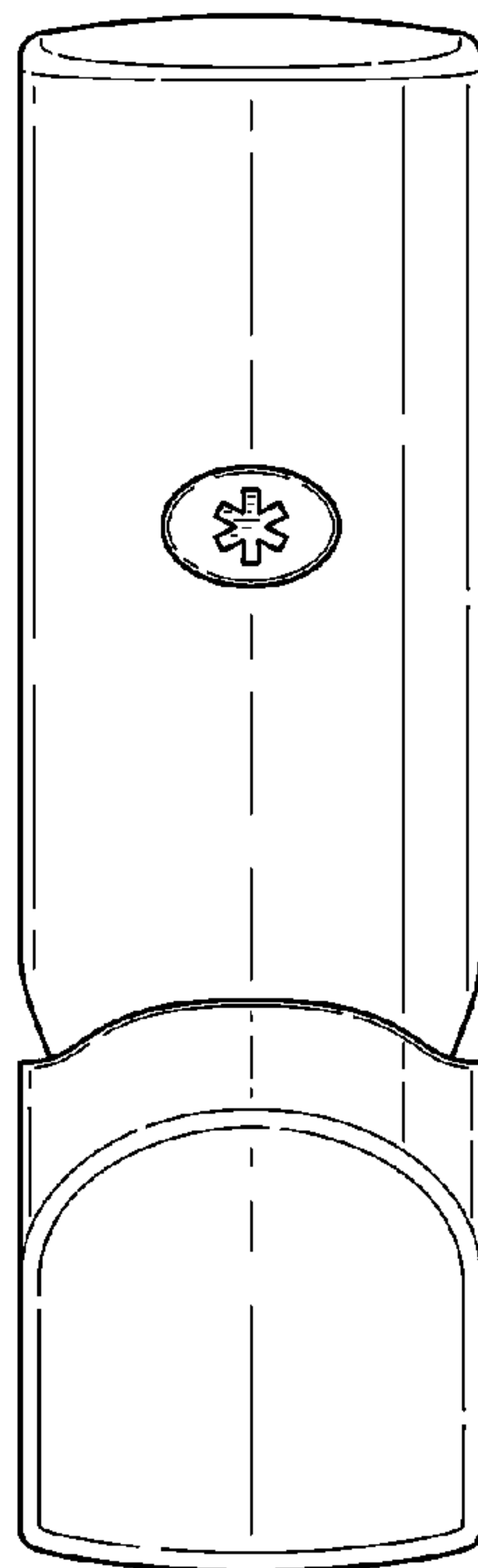

Fig. 10

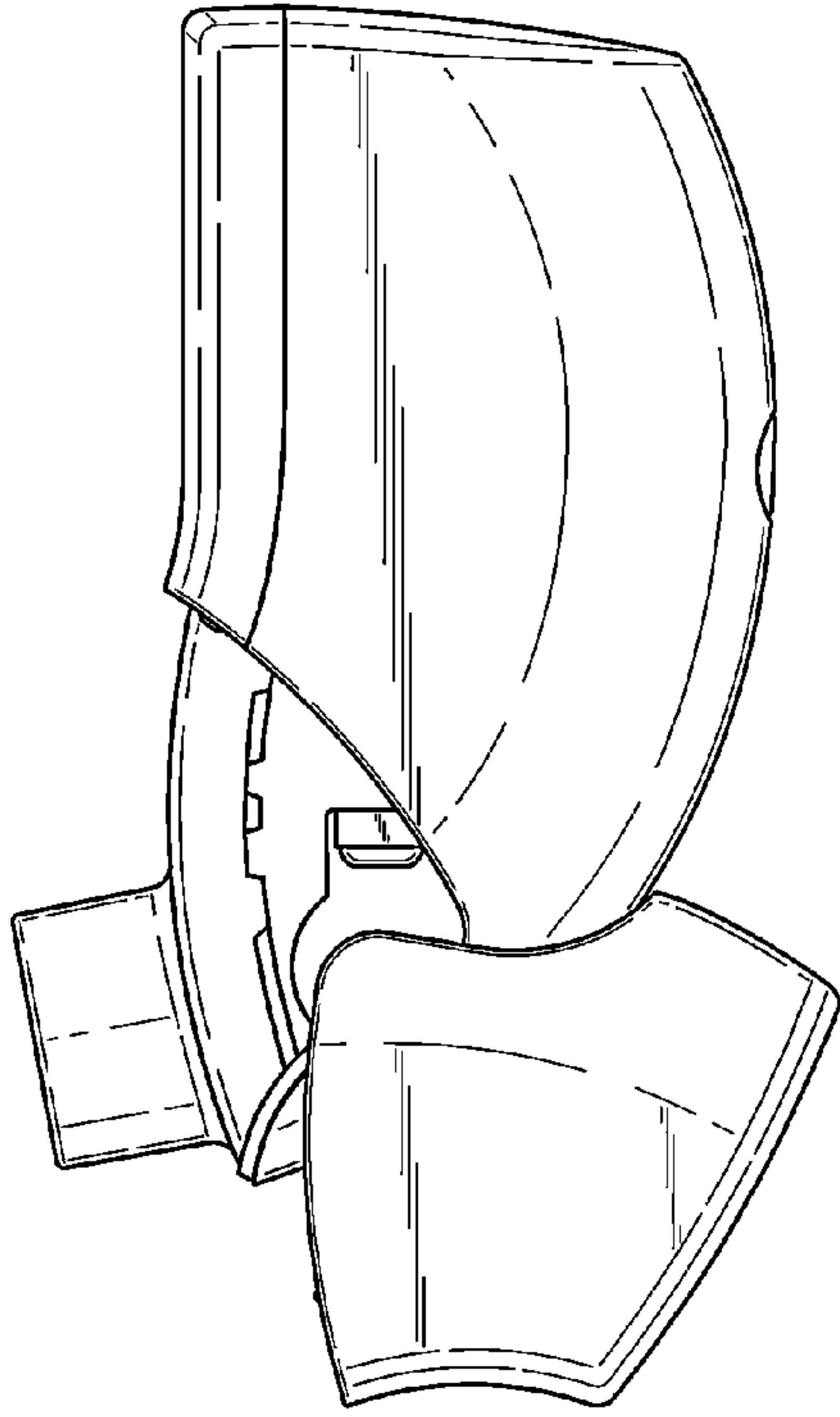

Fig. 11

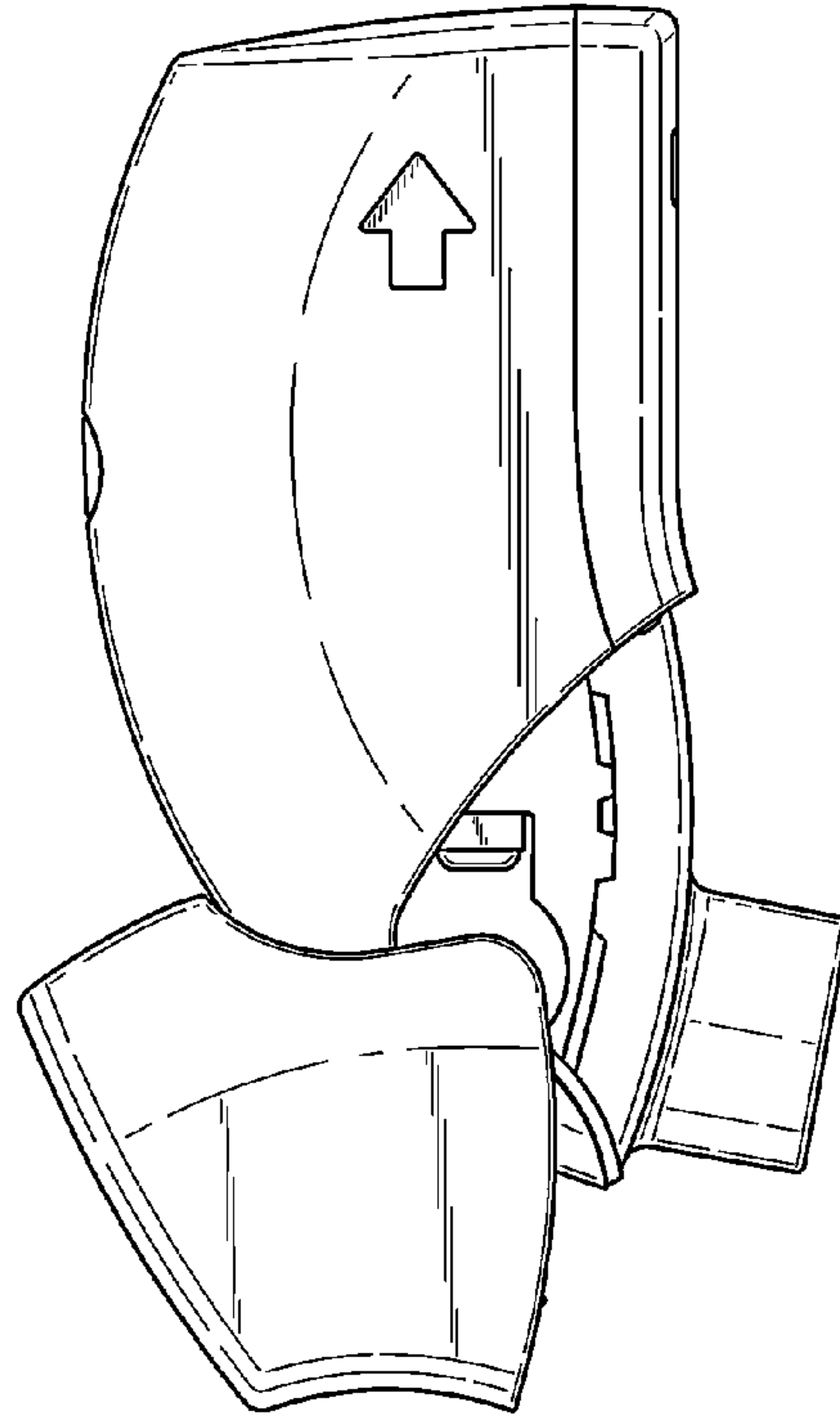

Fig. 12

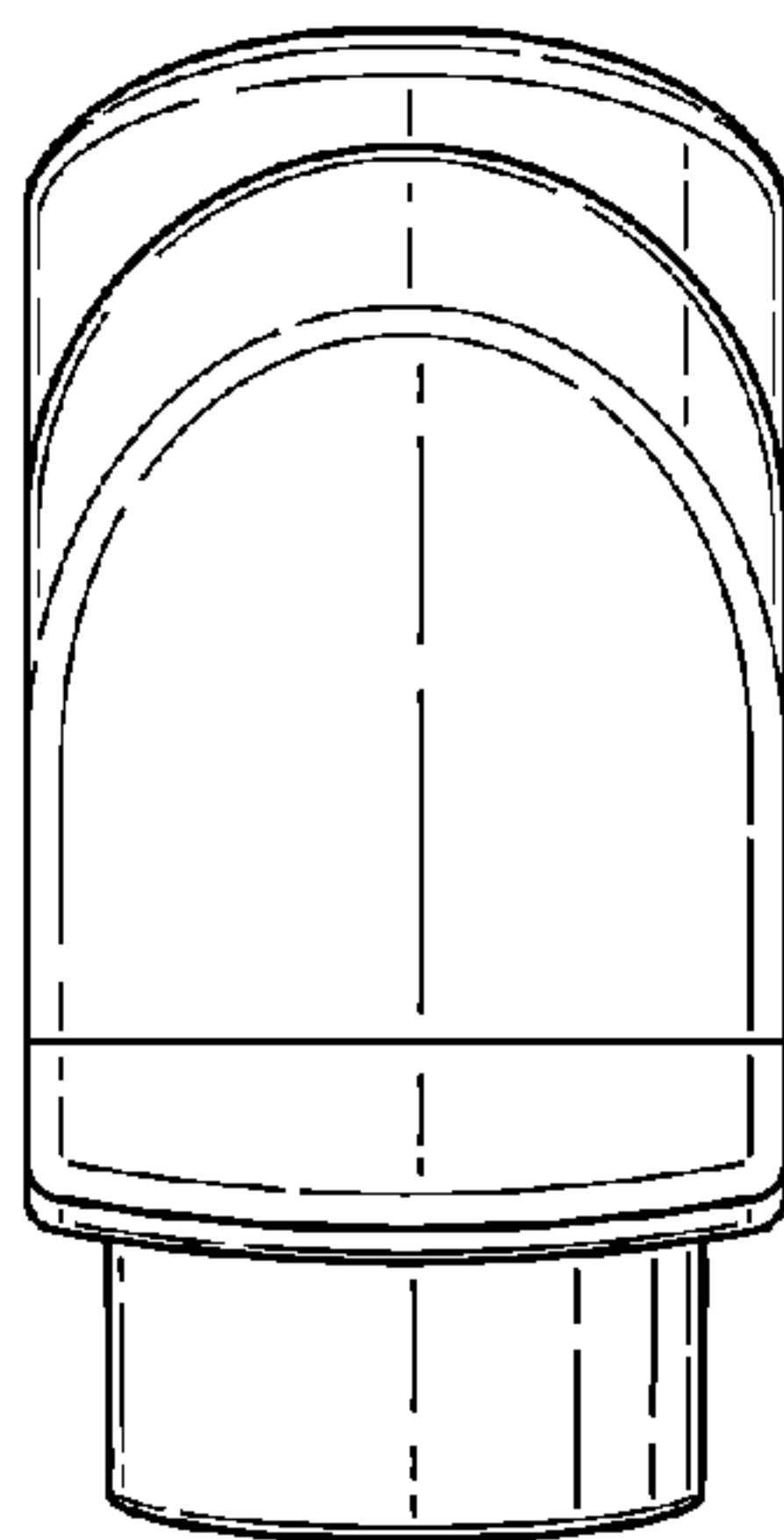

Fig. 13

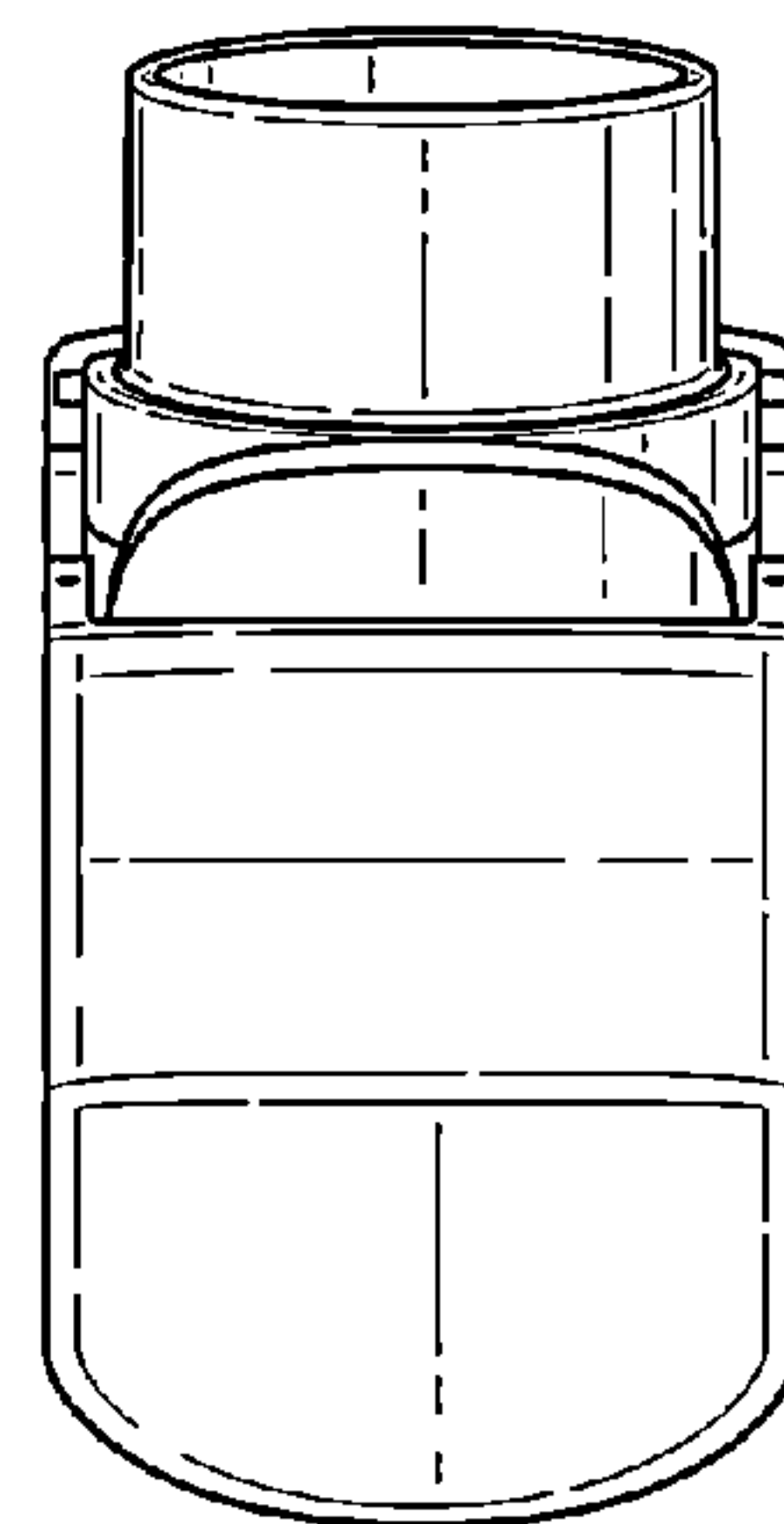

Fig. 14

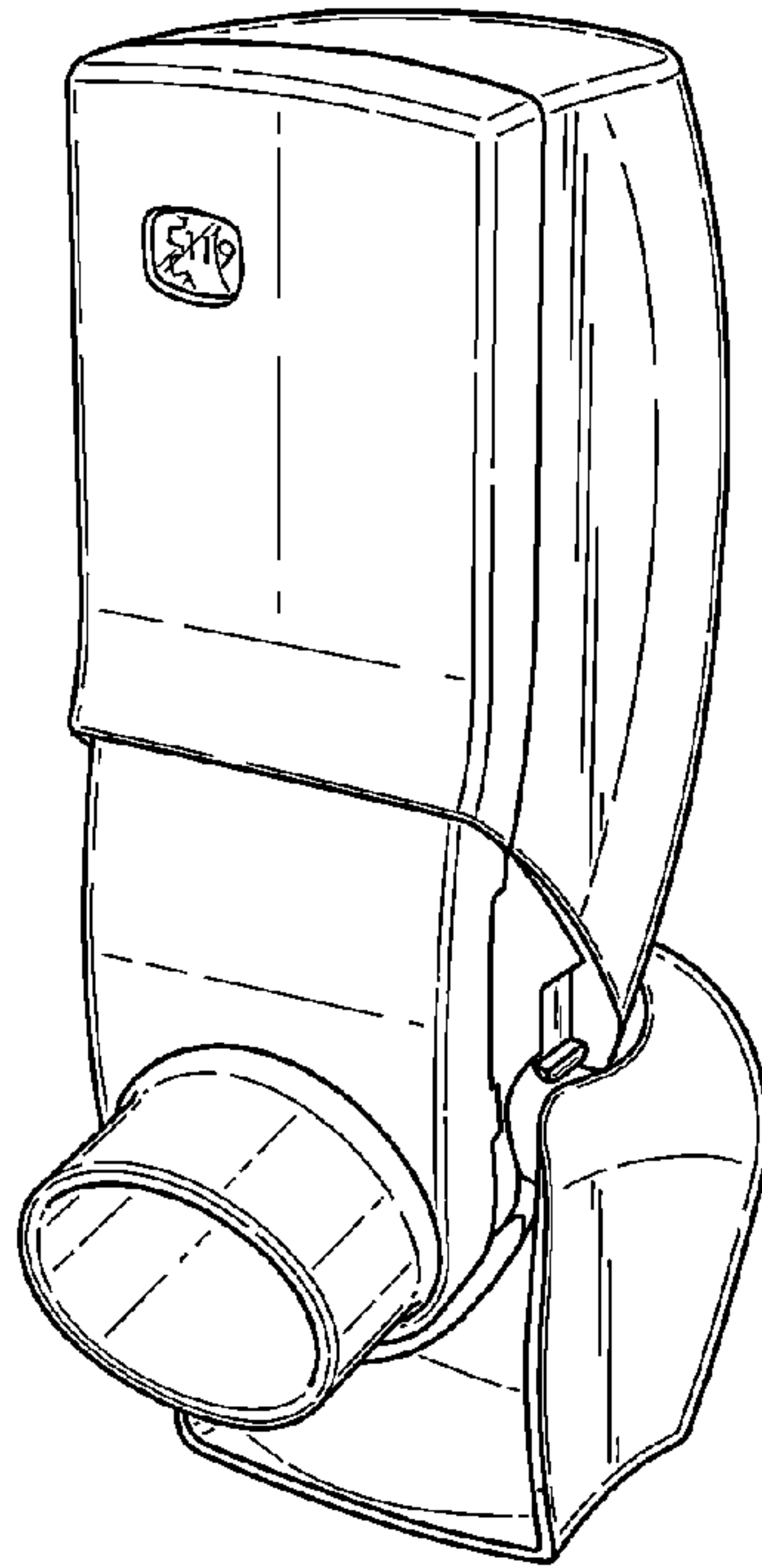

Fig. 15

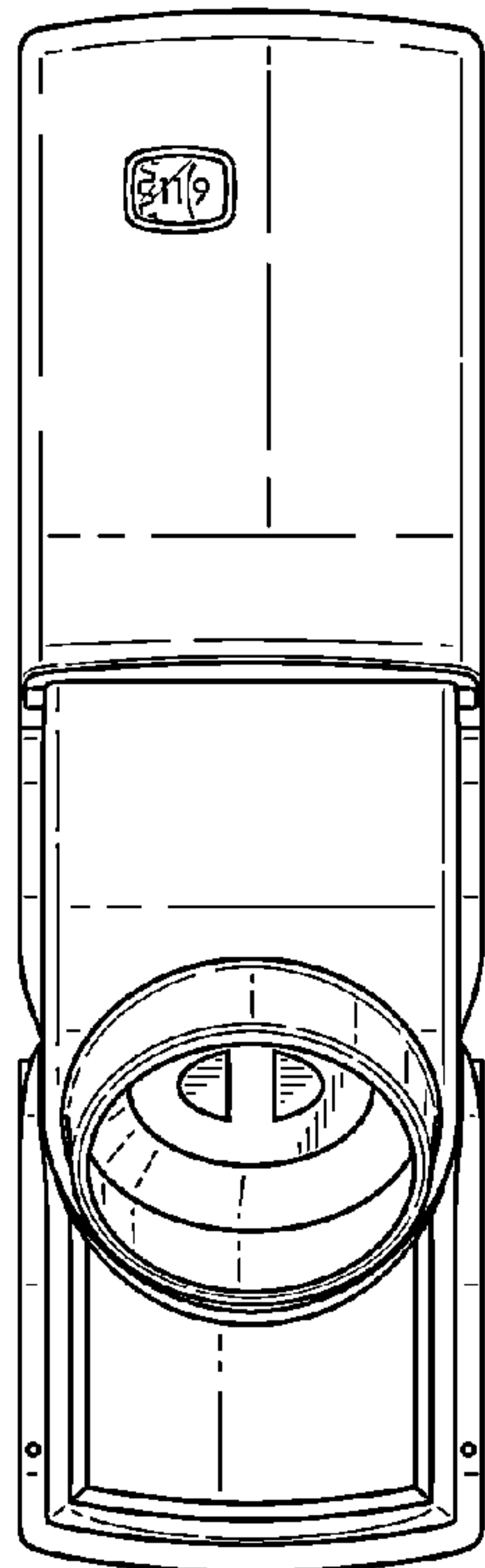

Fig. 16

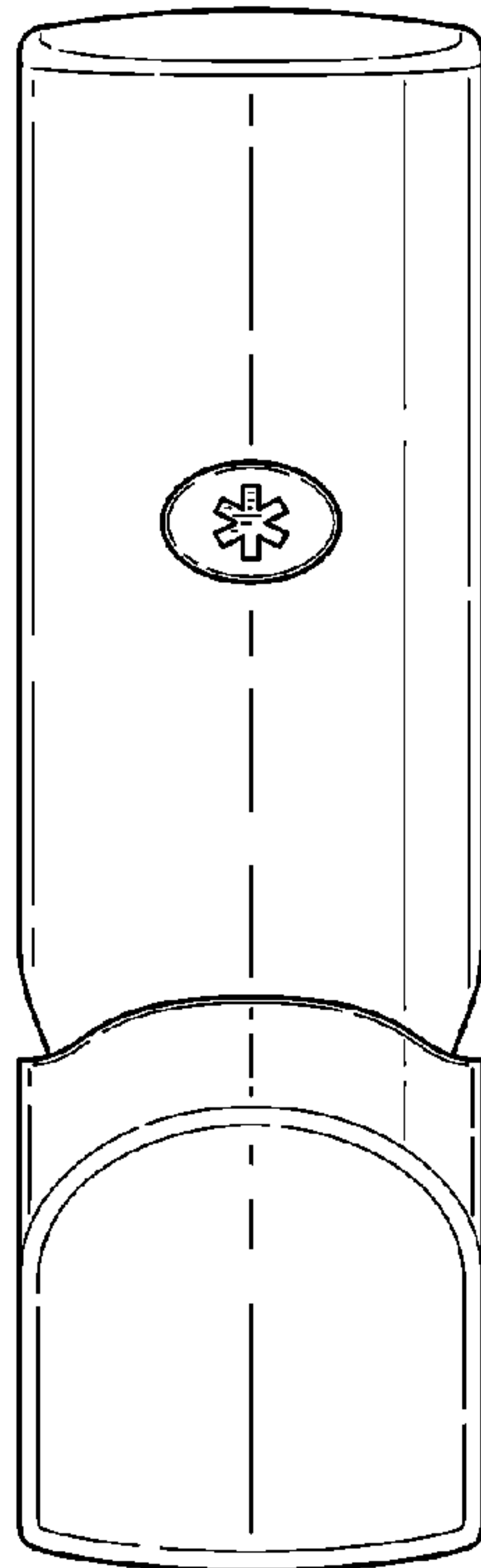

Fig. 17

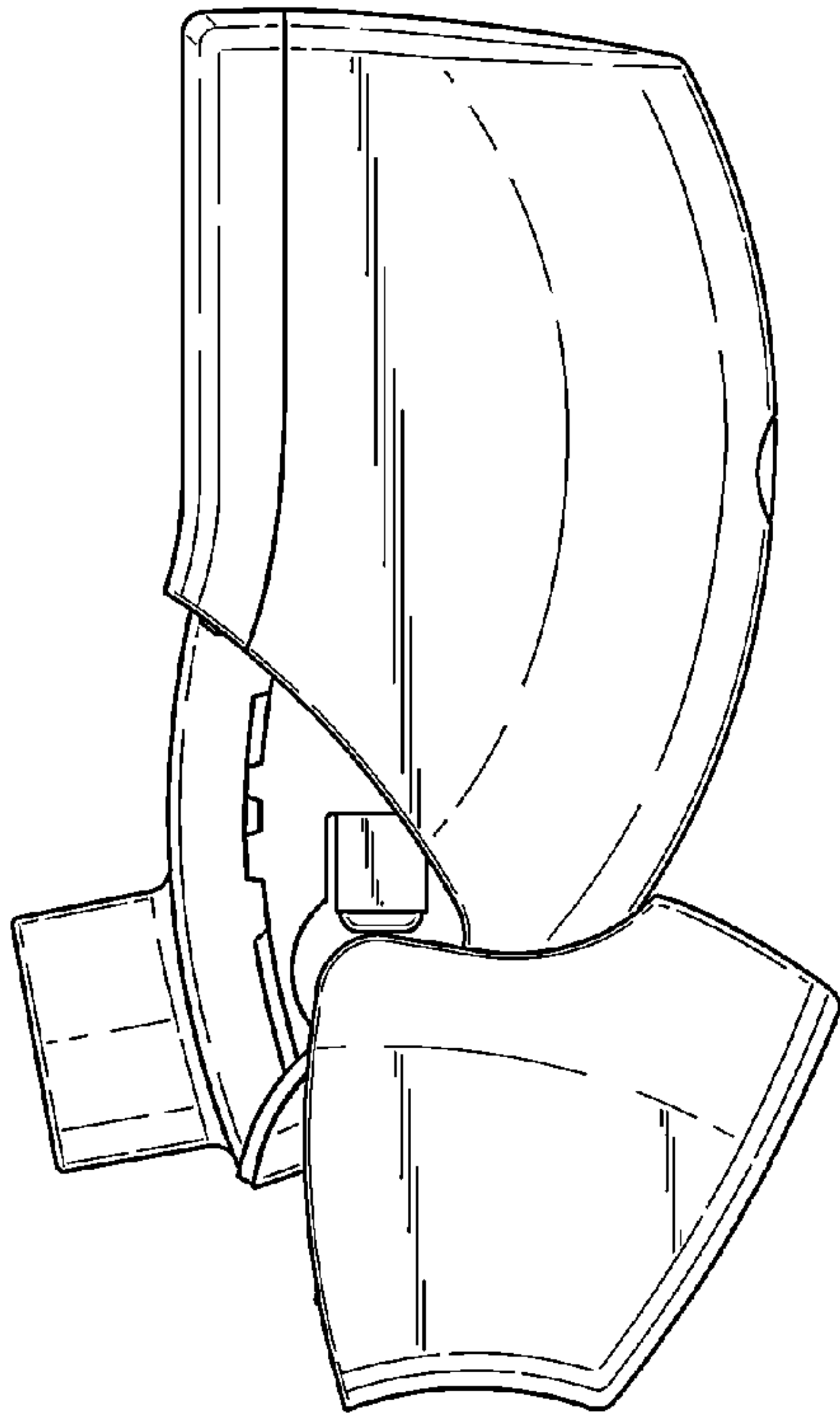

Fig. 18

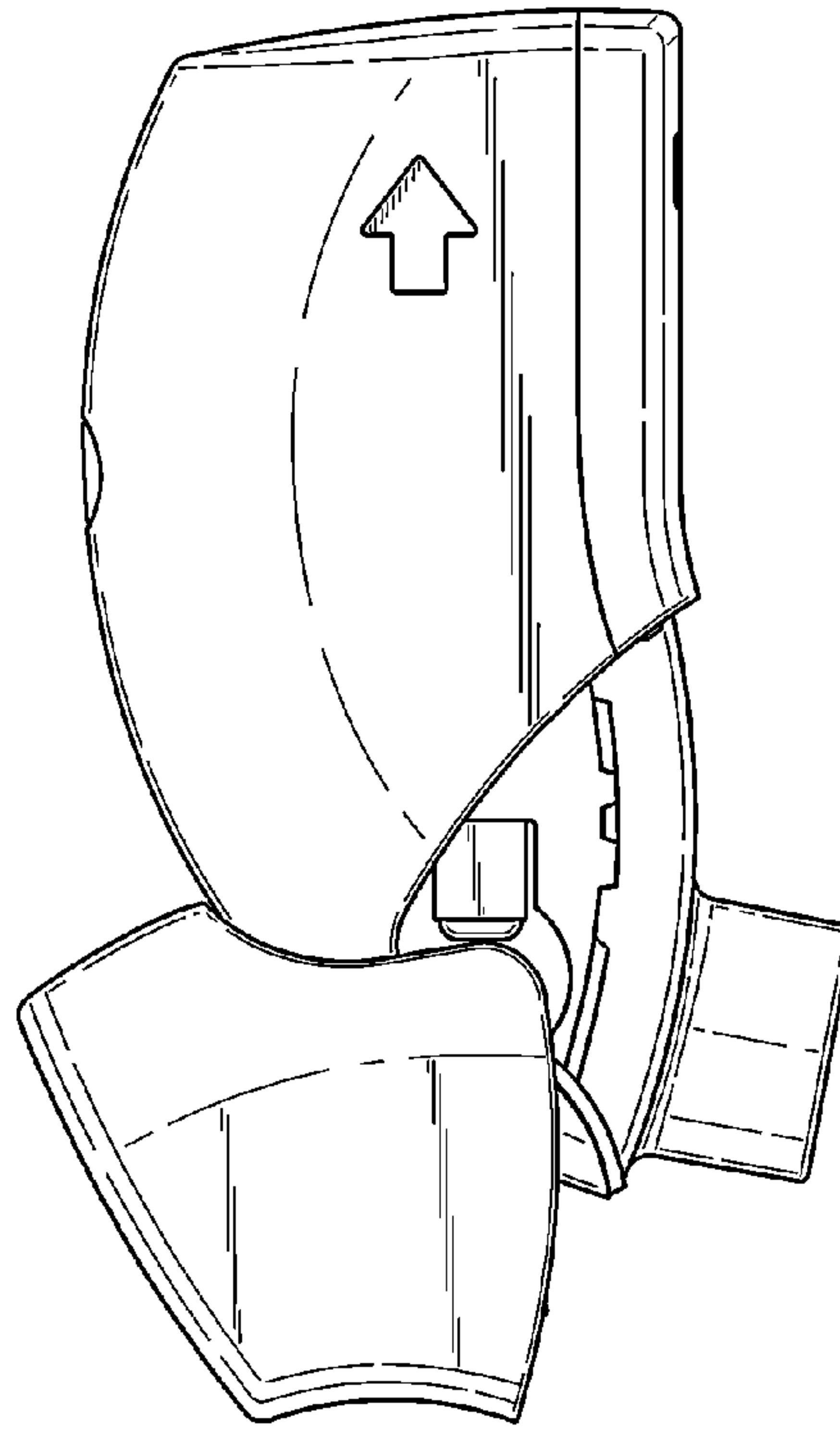

Fig. 19

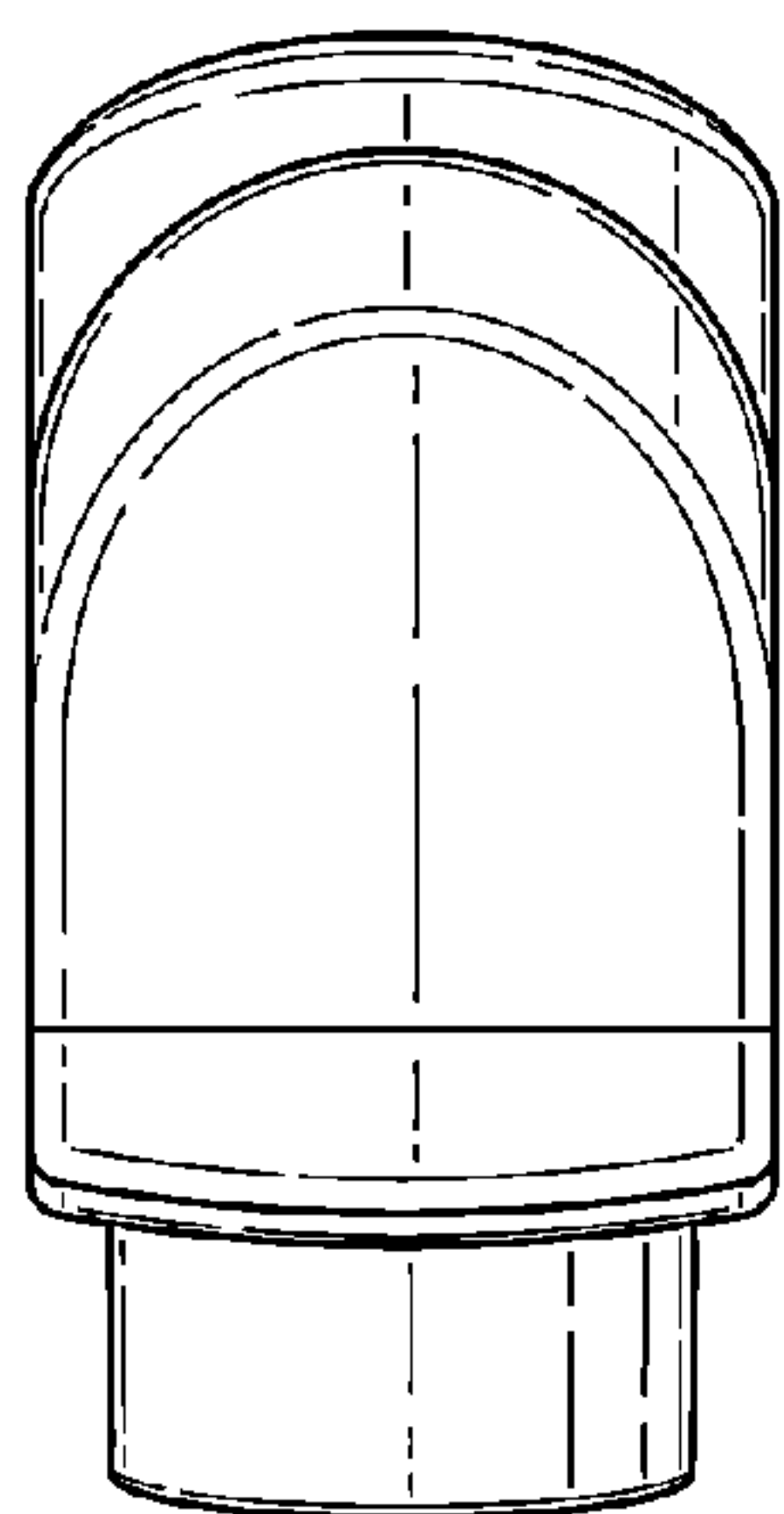

Fig. 20

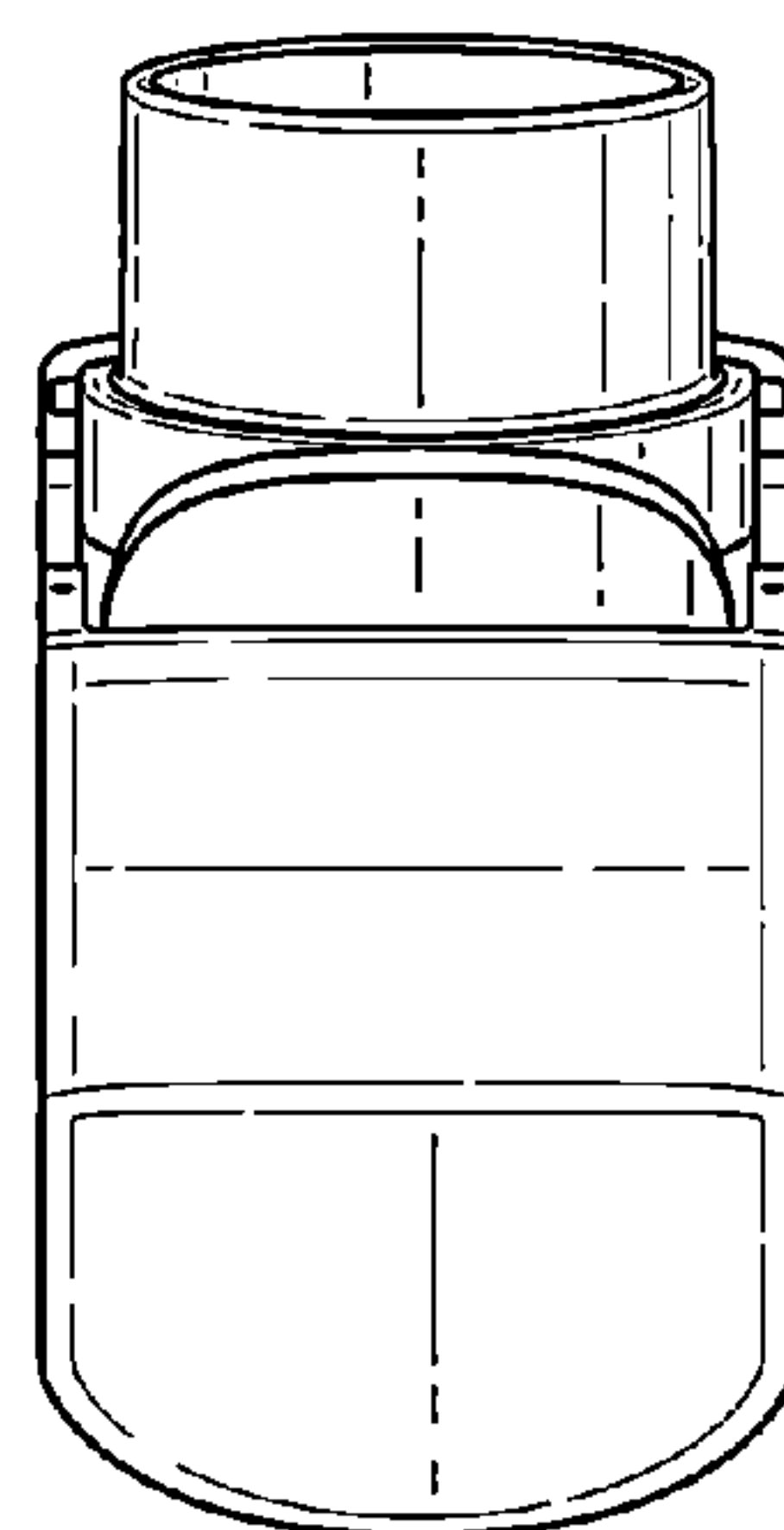

Fig. 21

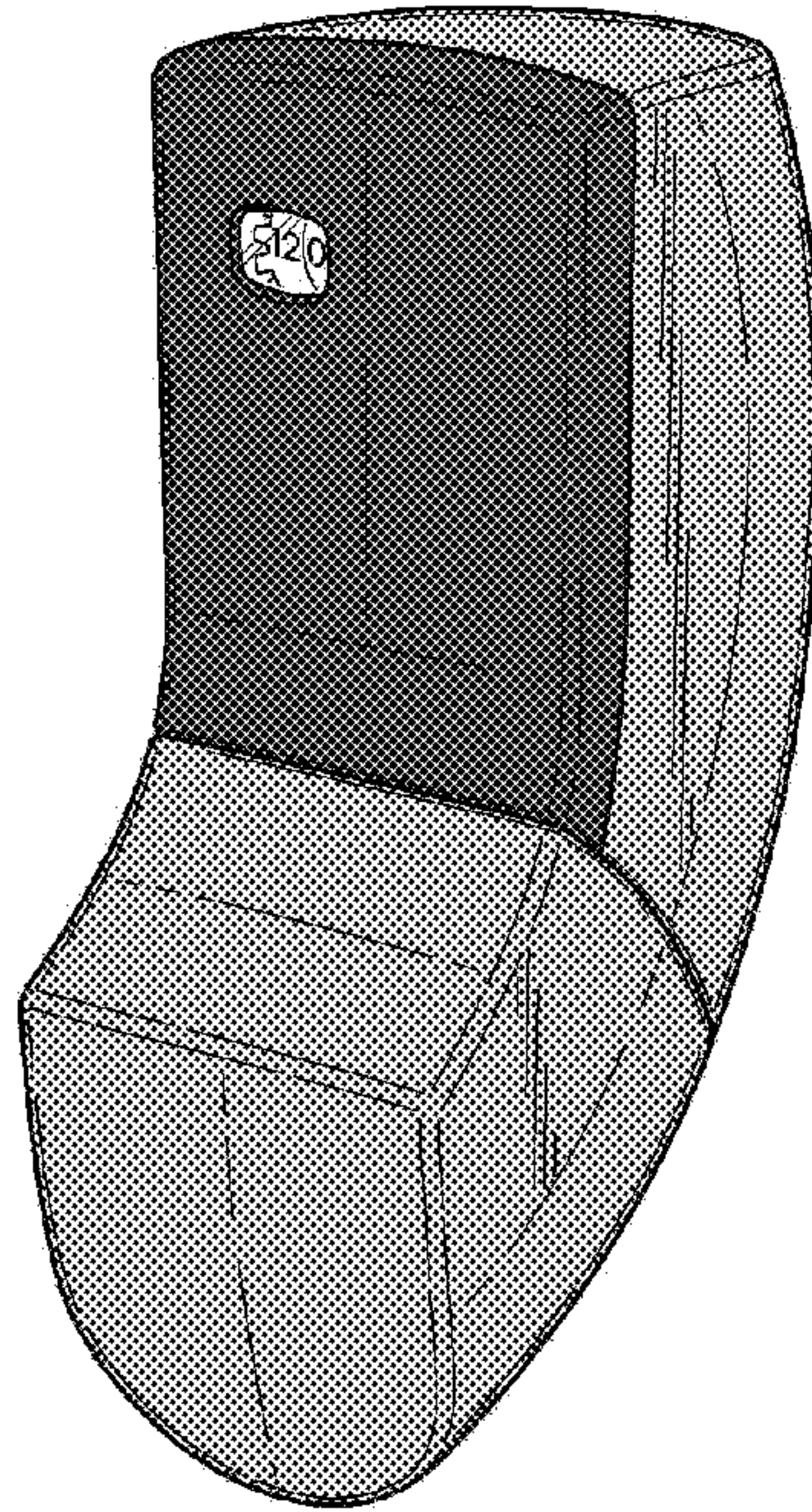

Fig. 22

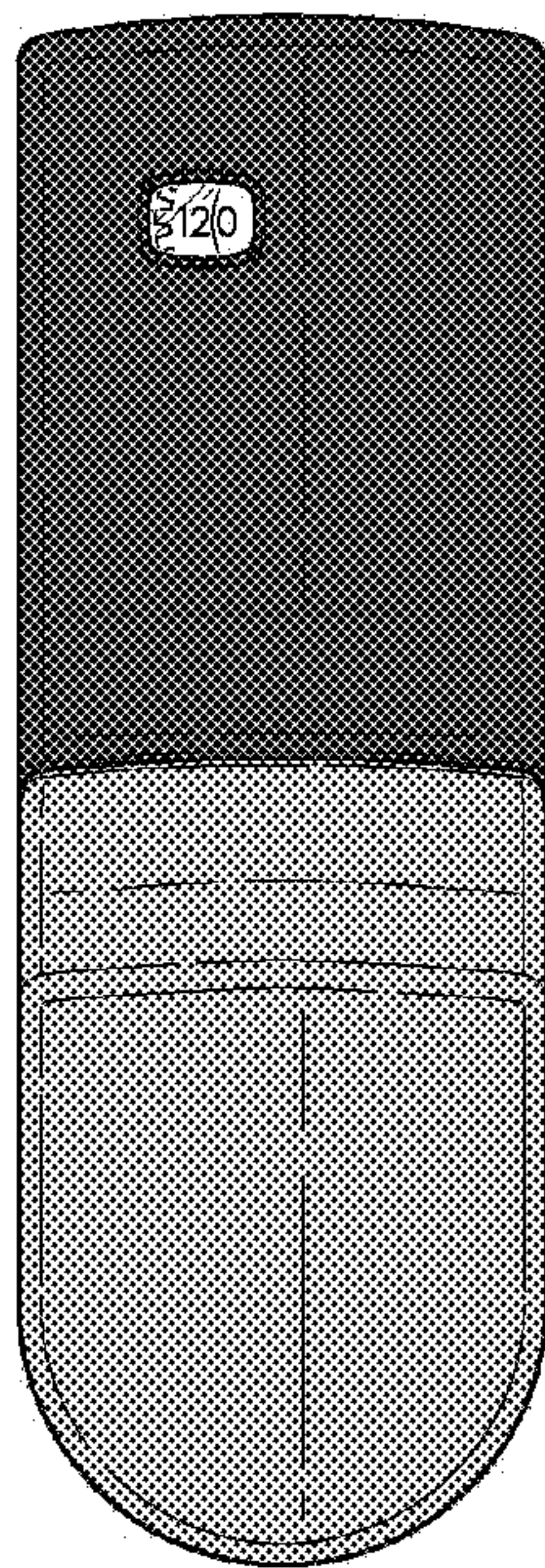

Fig. 23

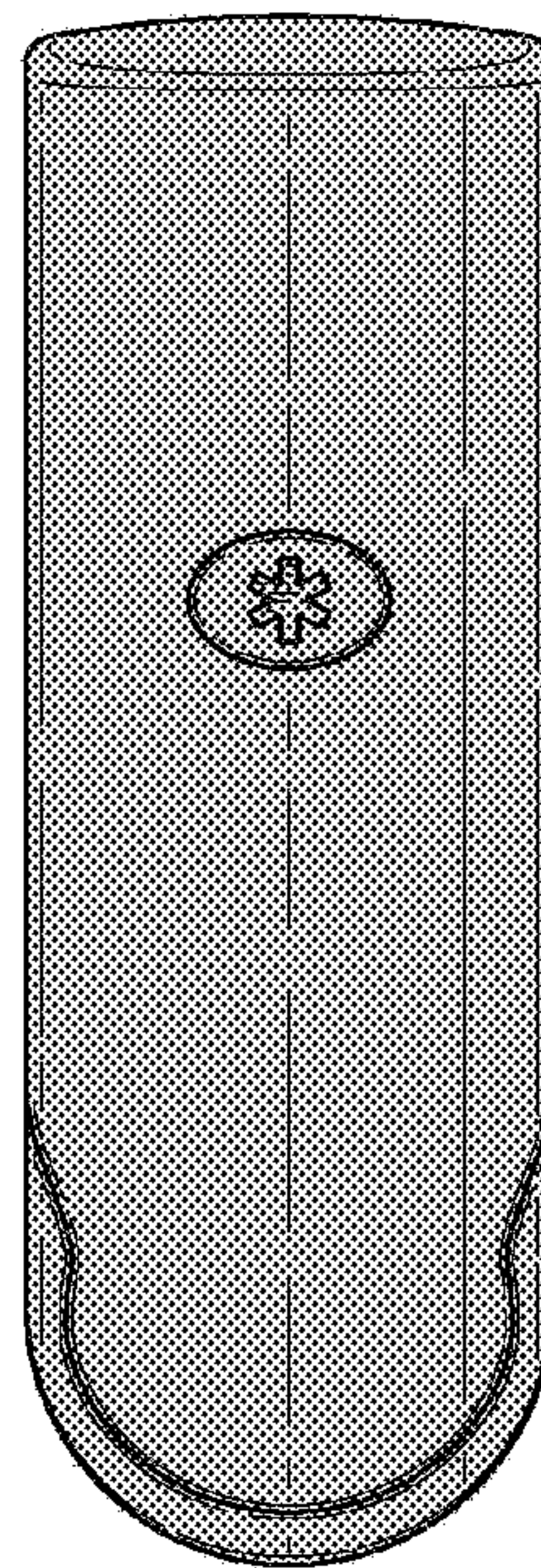

Fig. 24

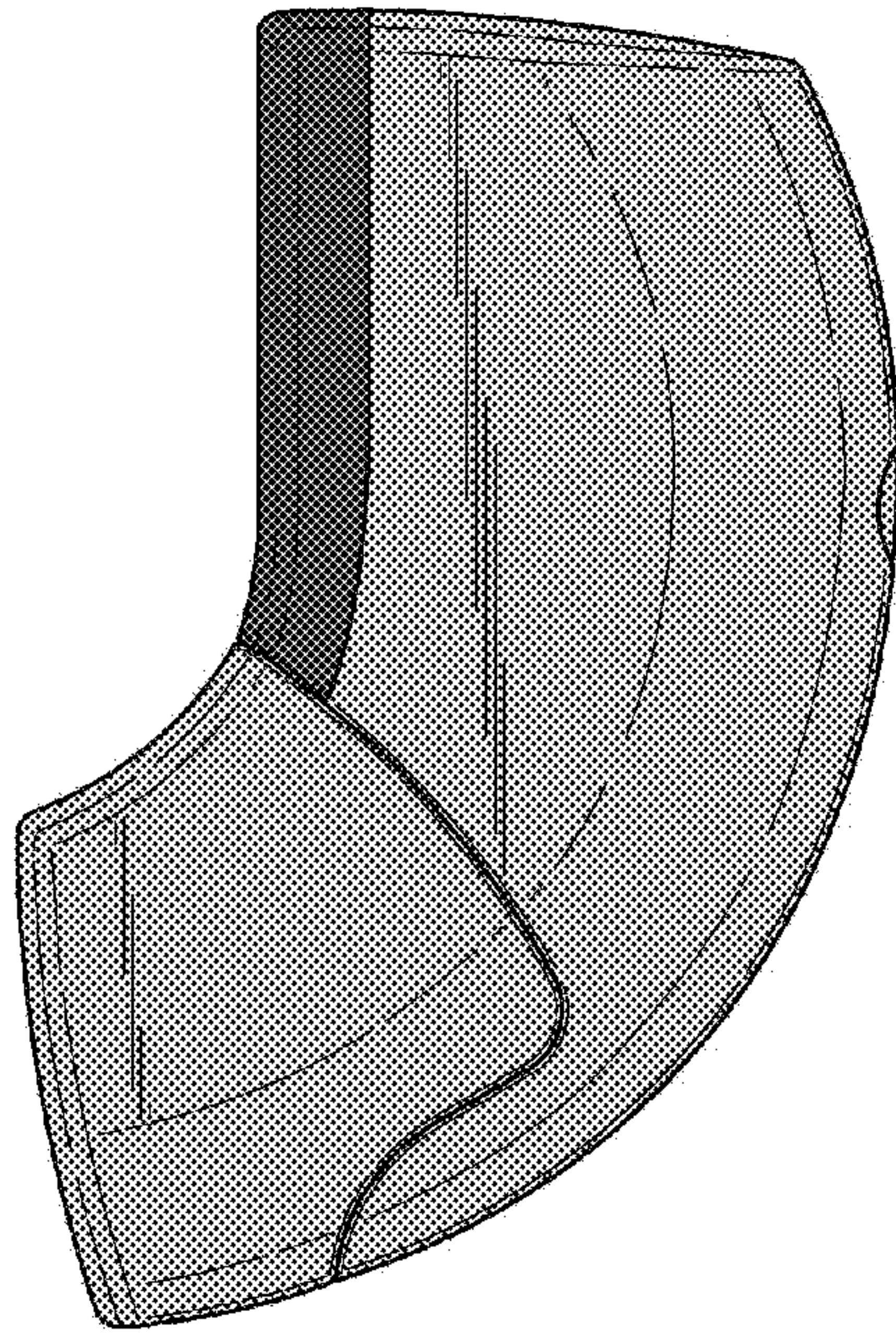

Fig. 25

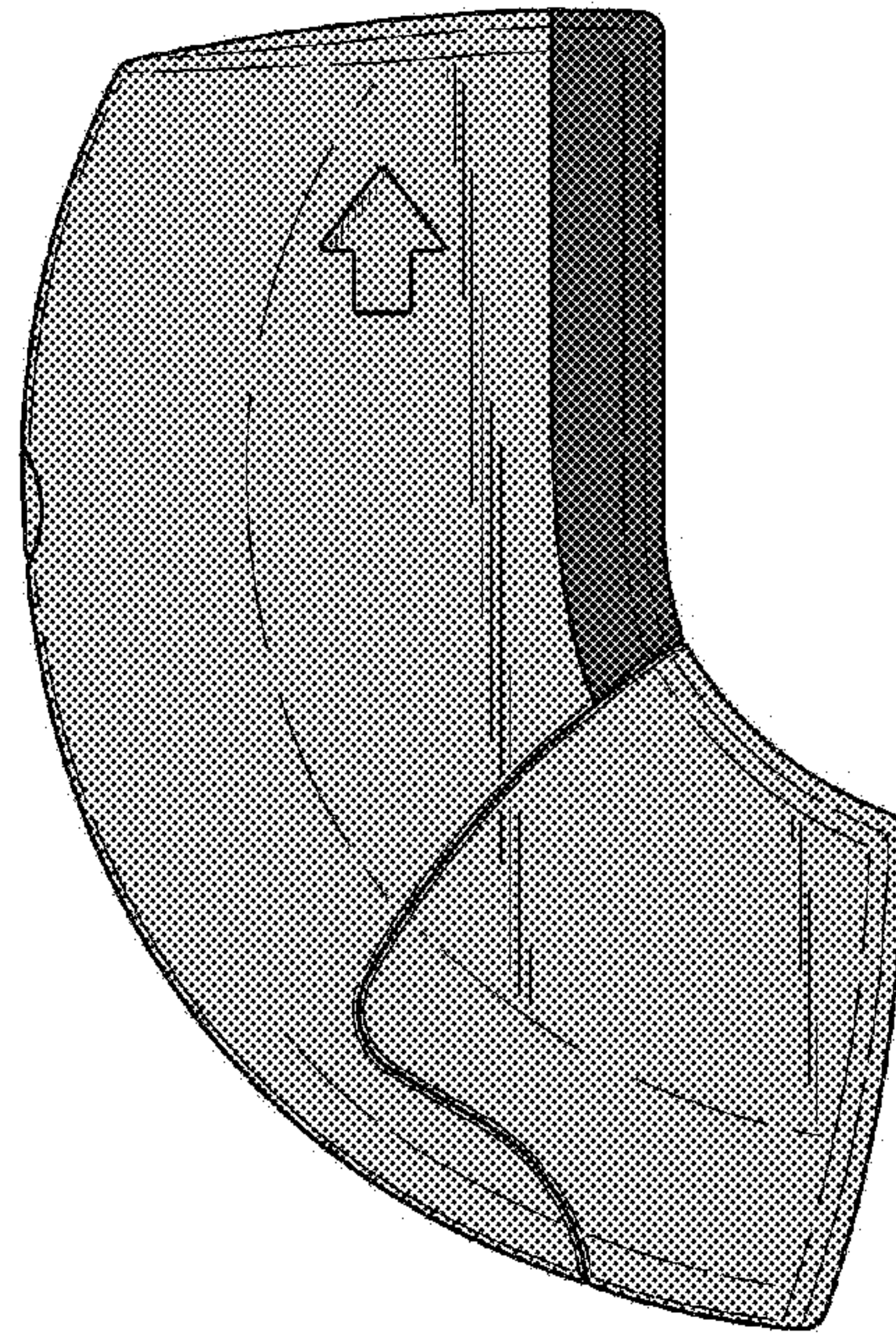

Fig. 26

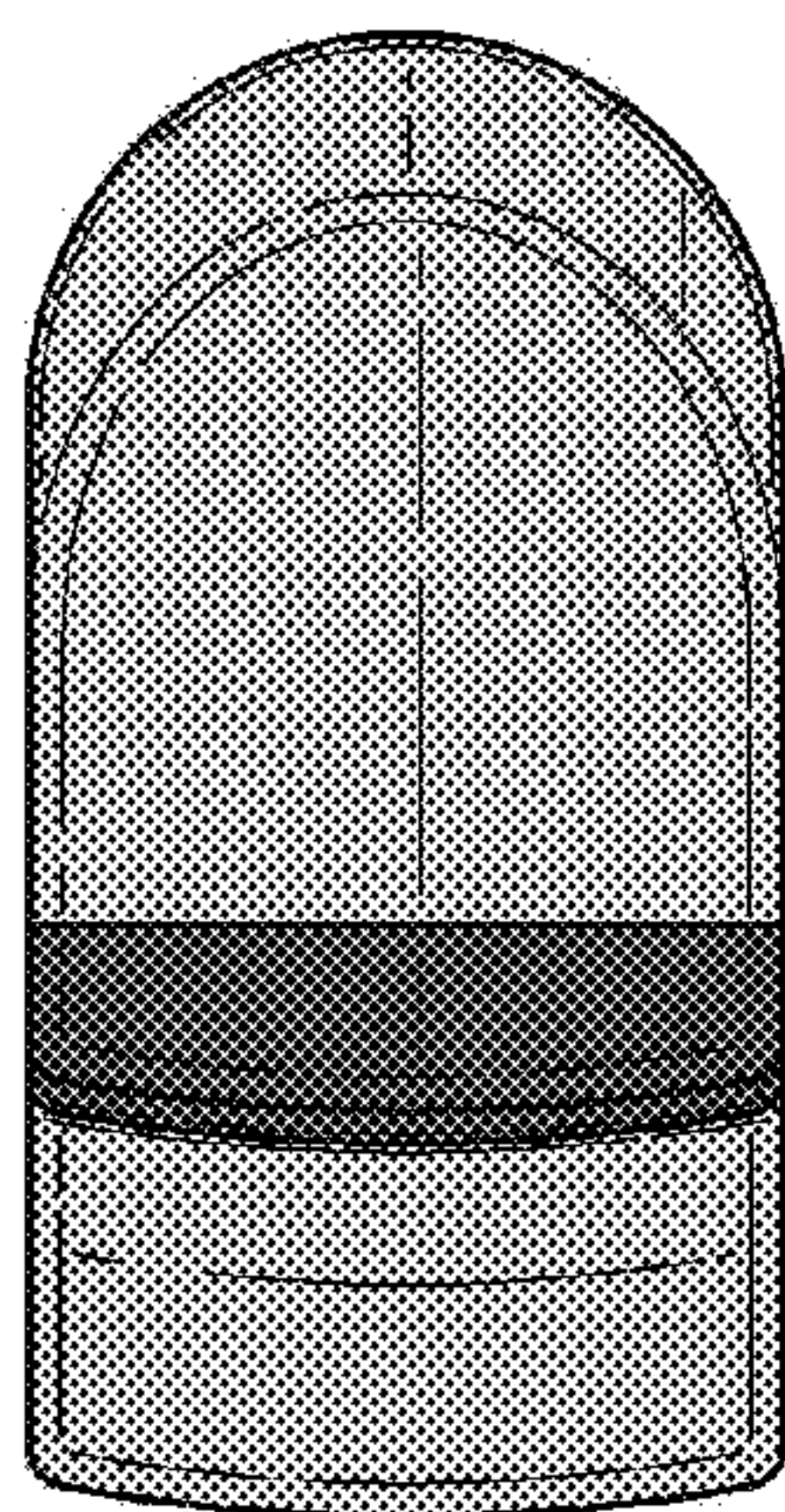

Fig. 27

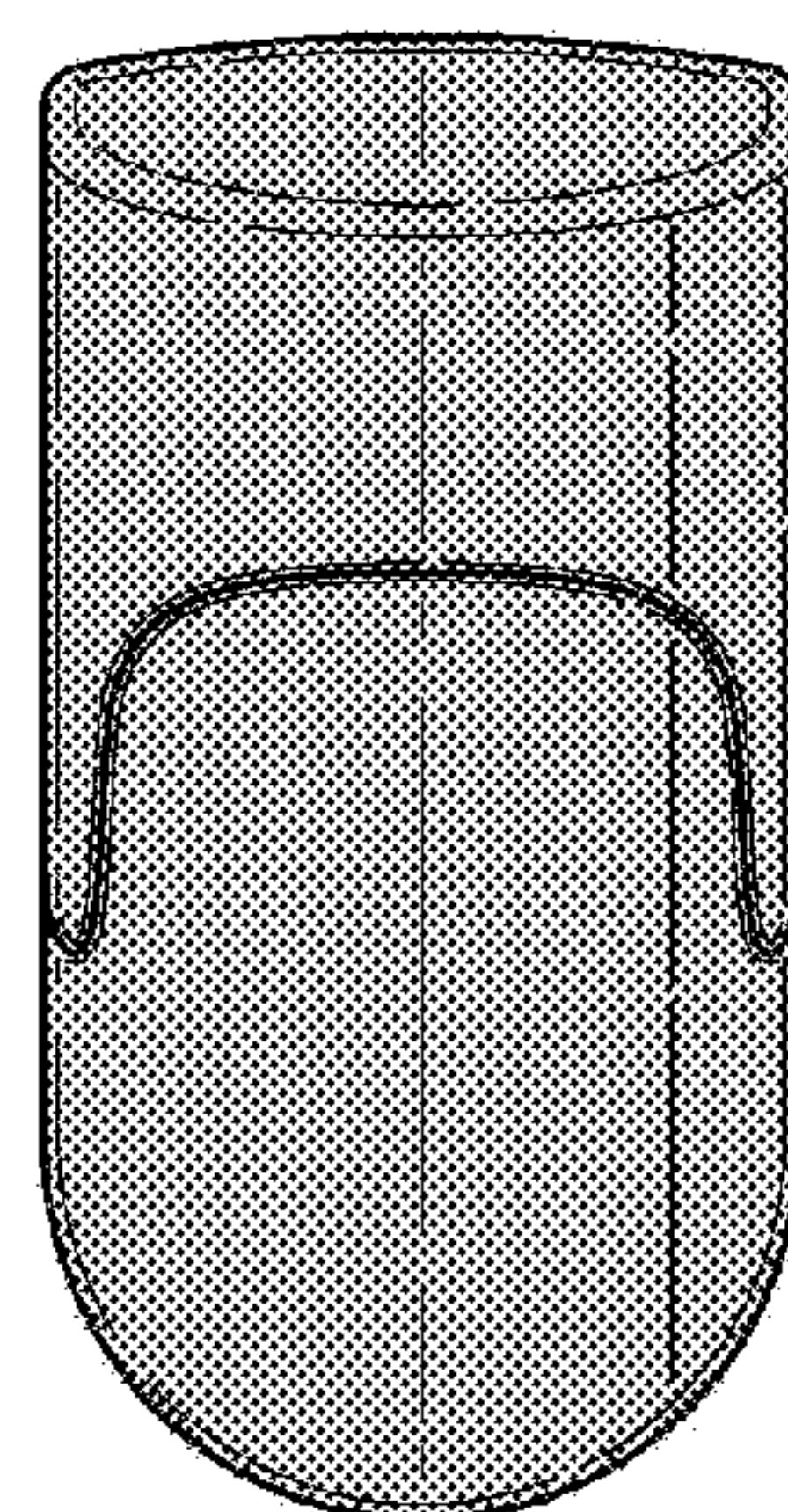

Fig. 28

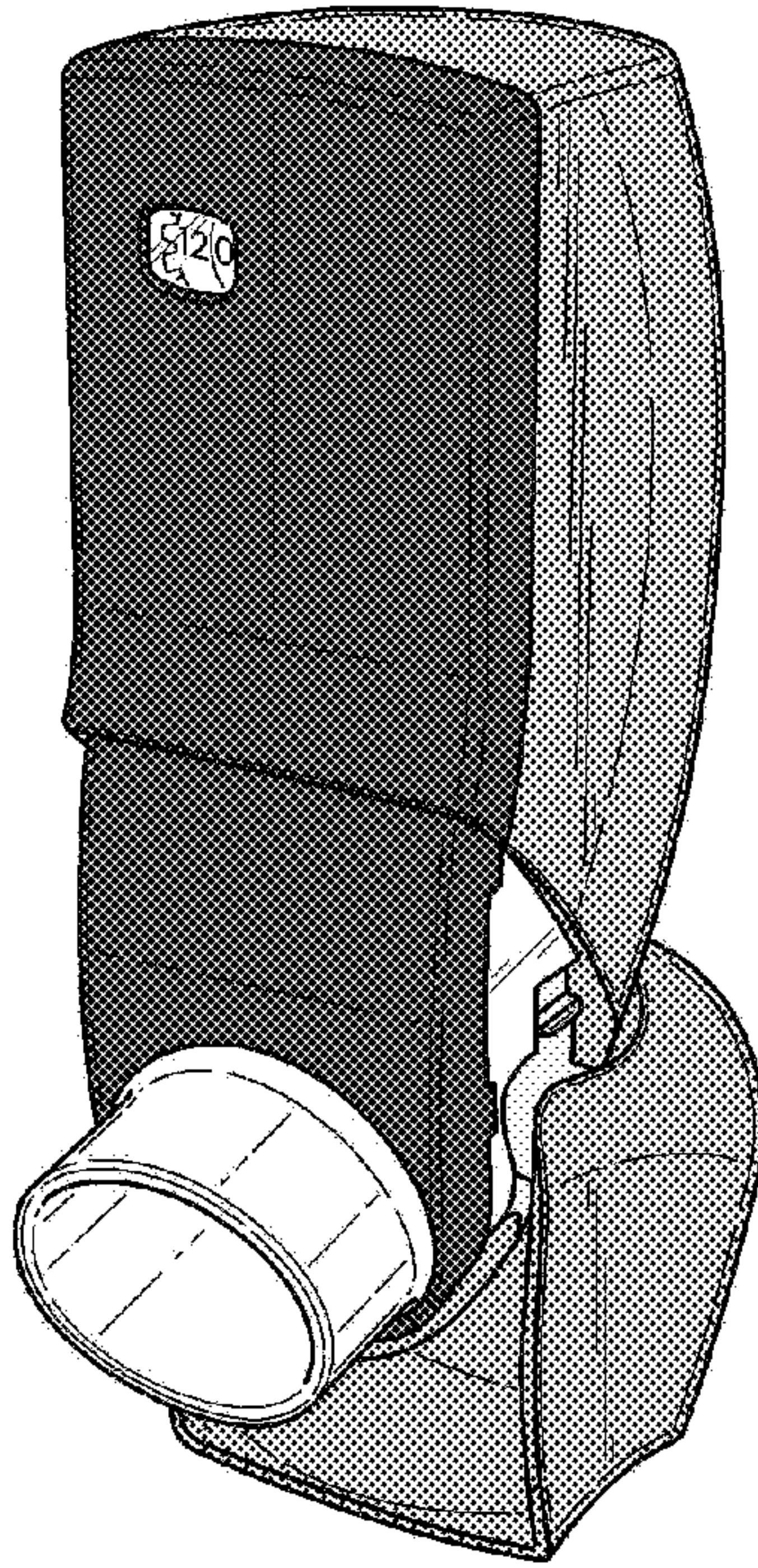

Fig. 29

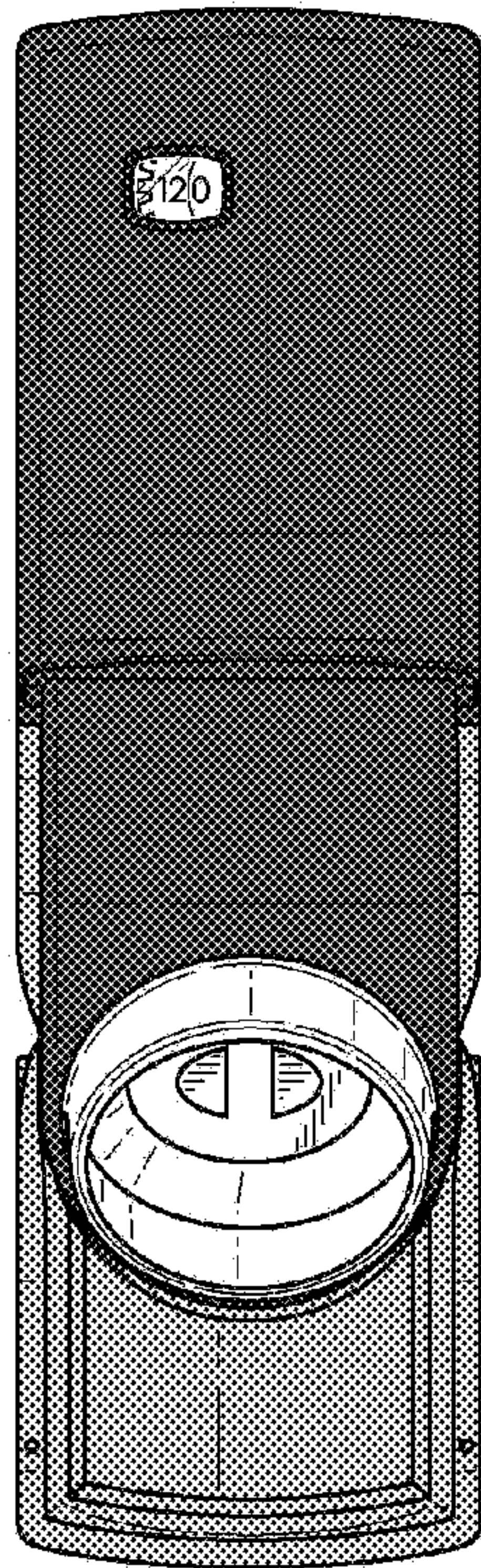

Fig. 30

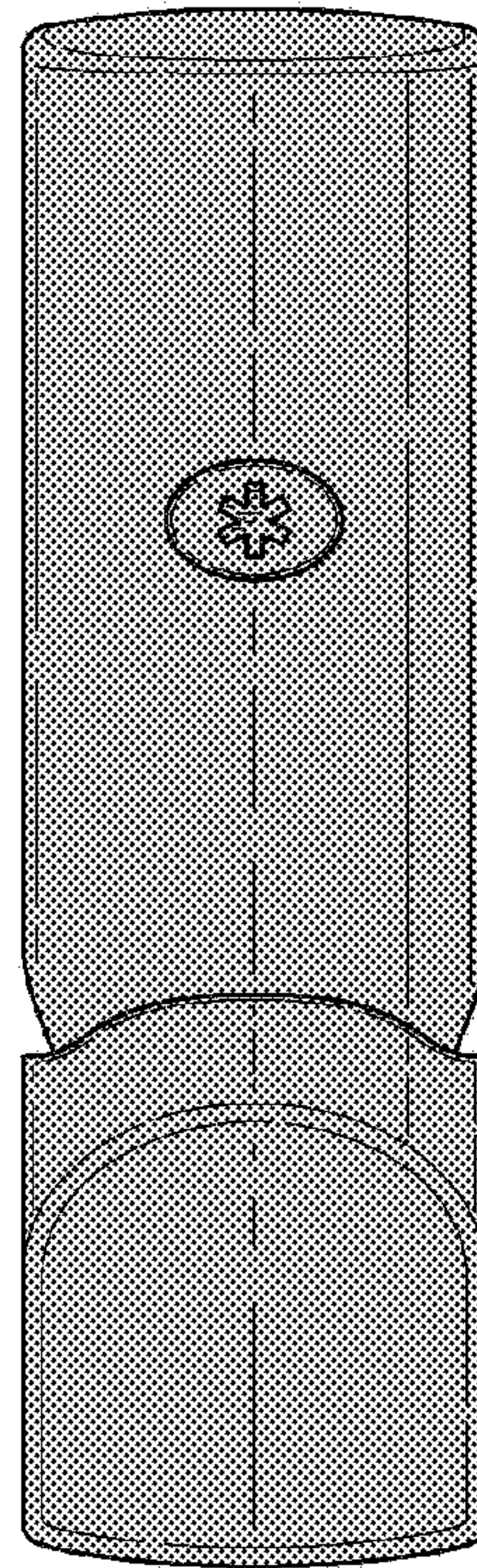

Fig. 31

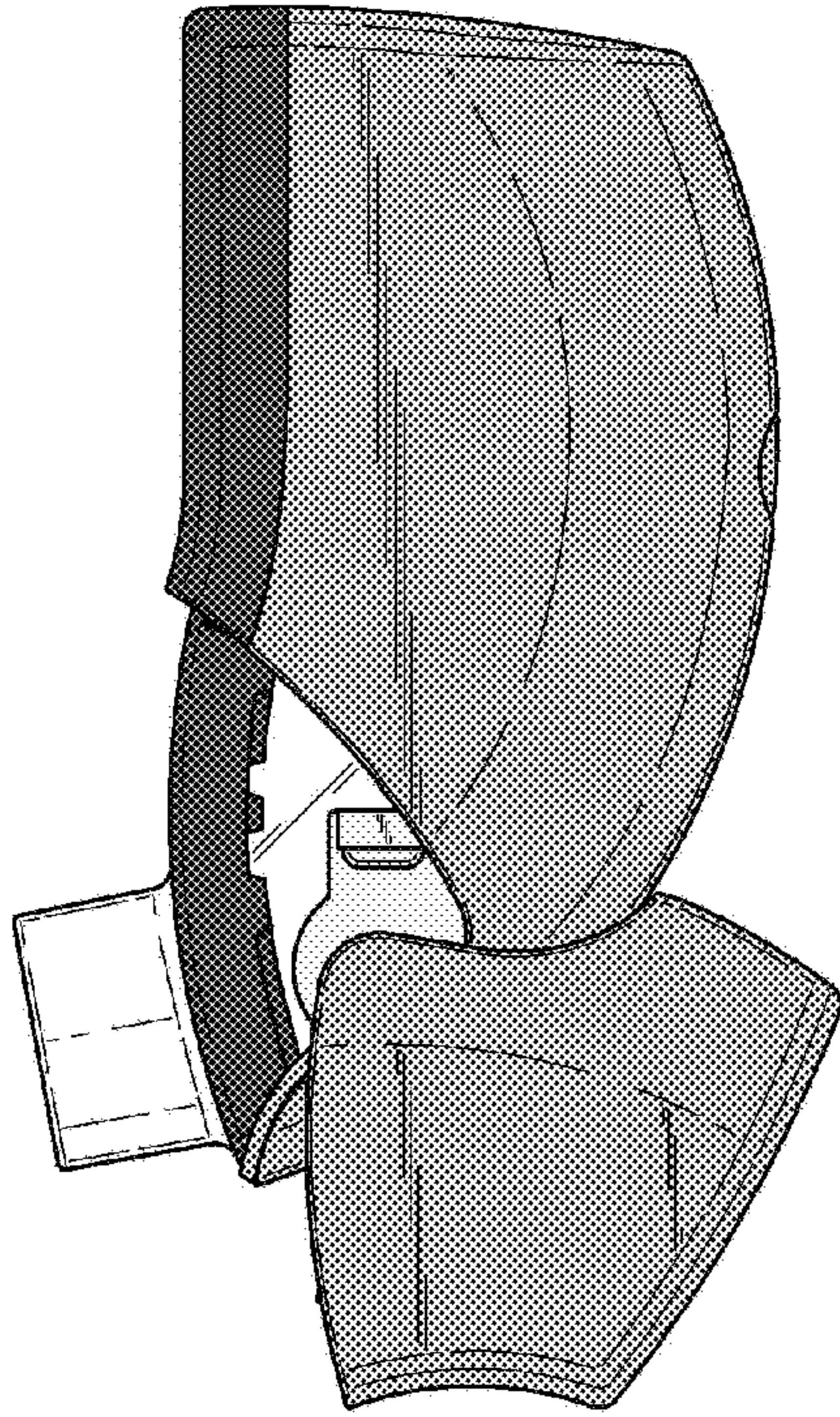

Fig. 32

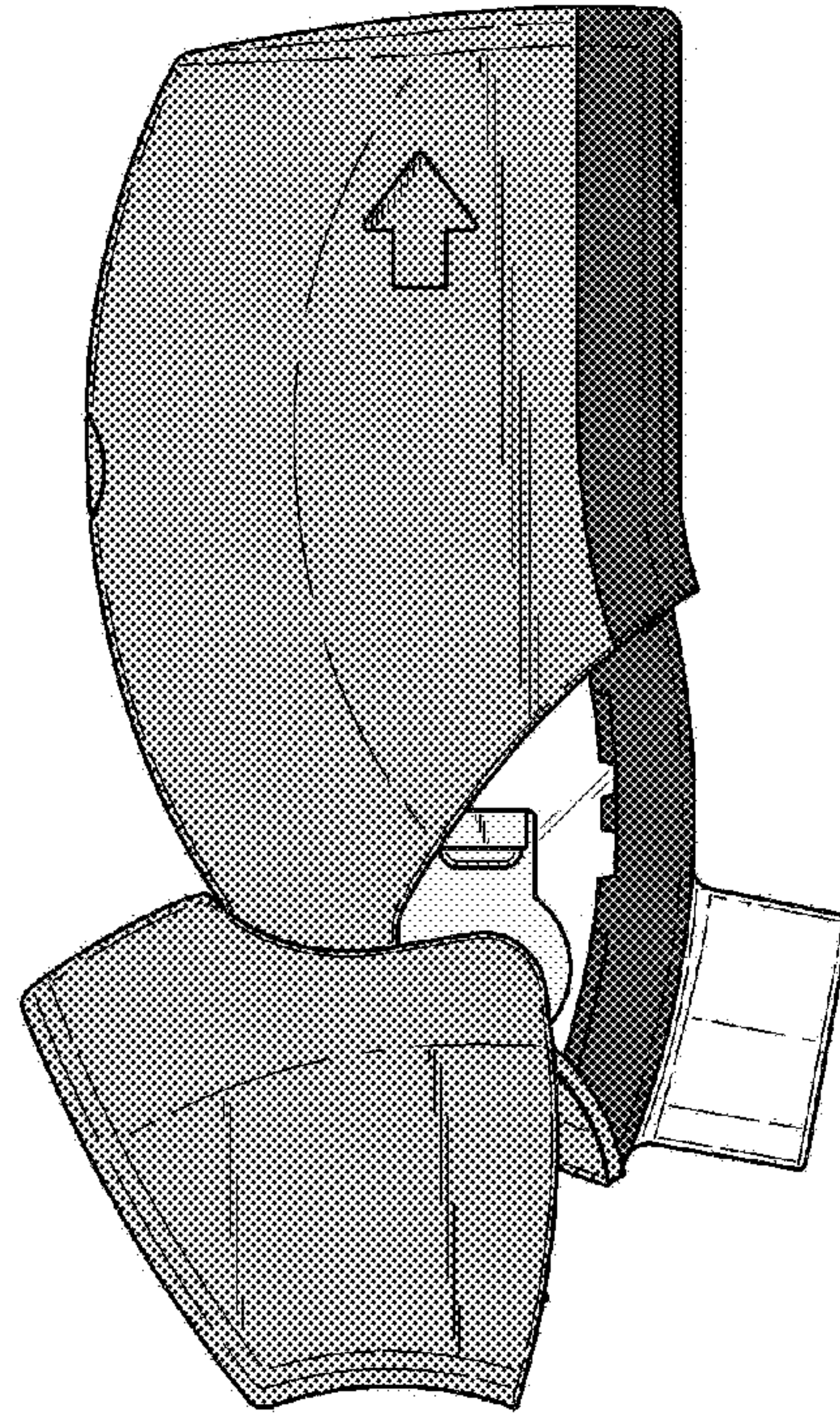

Fig. 33

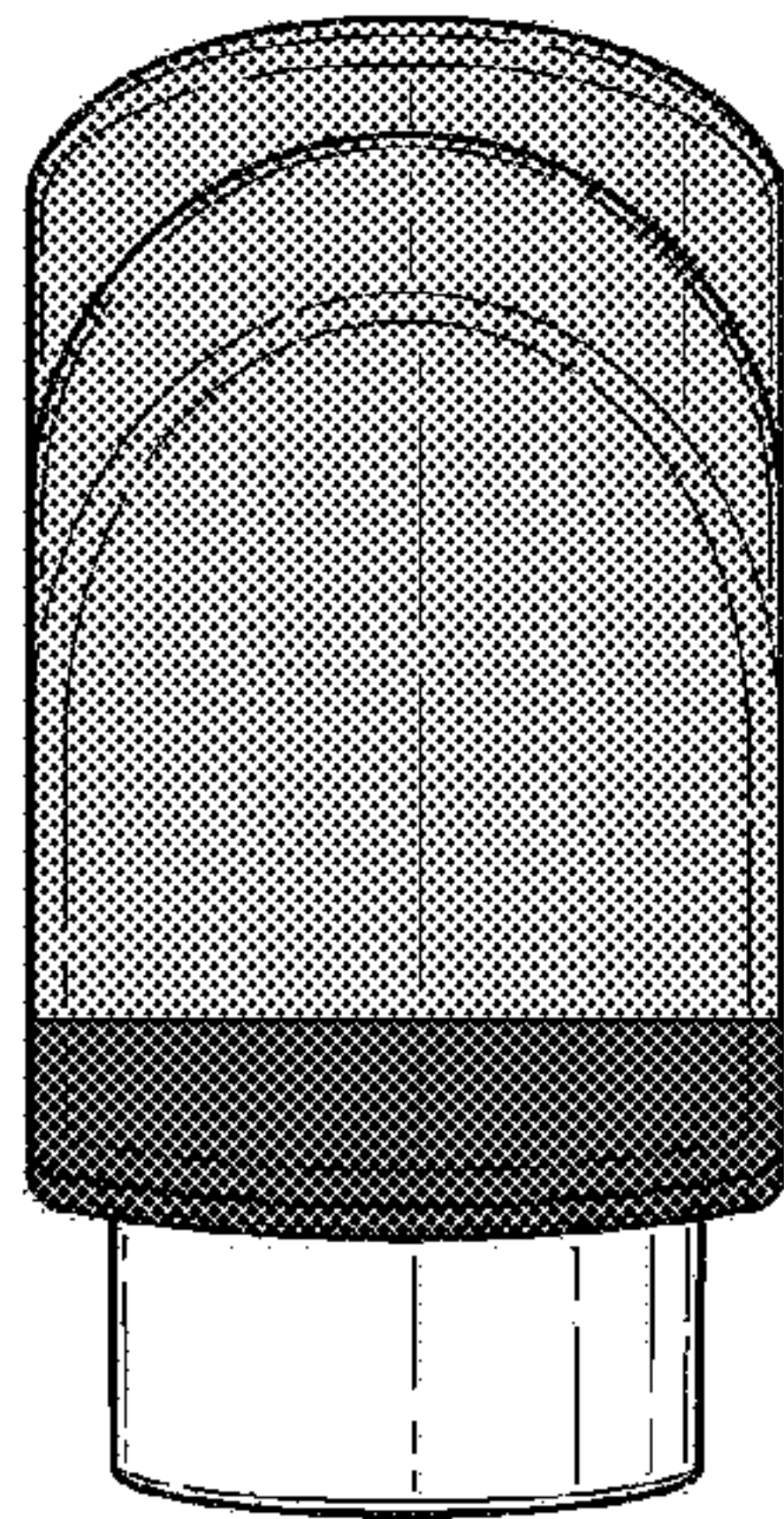

Fig. 34

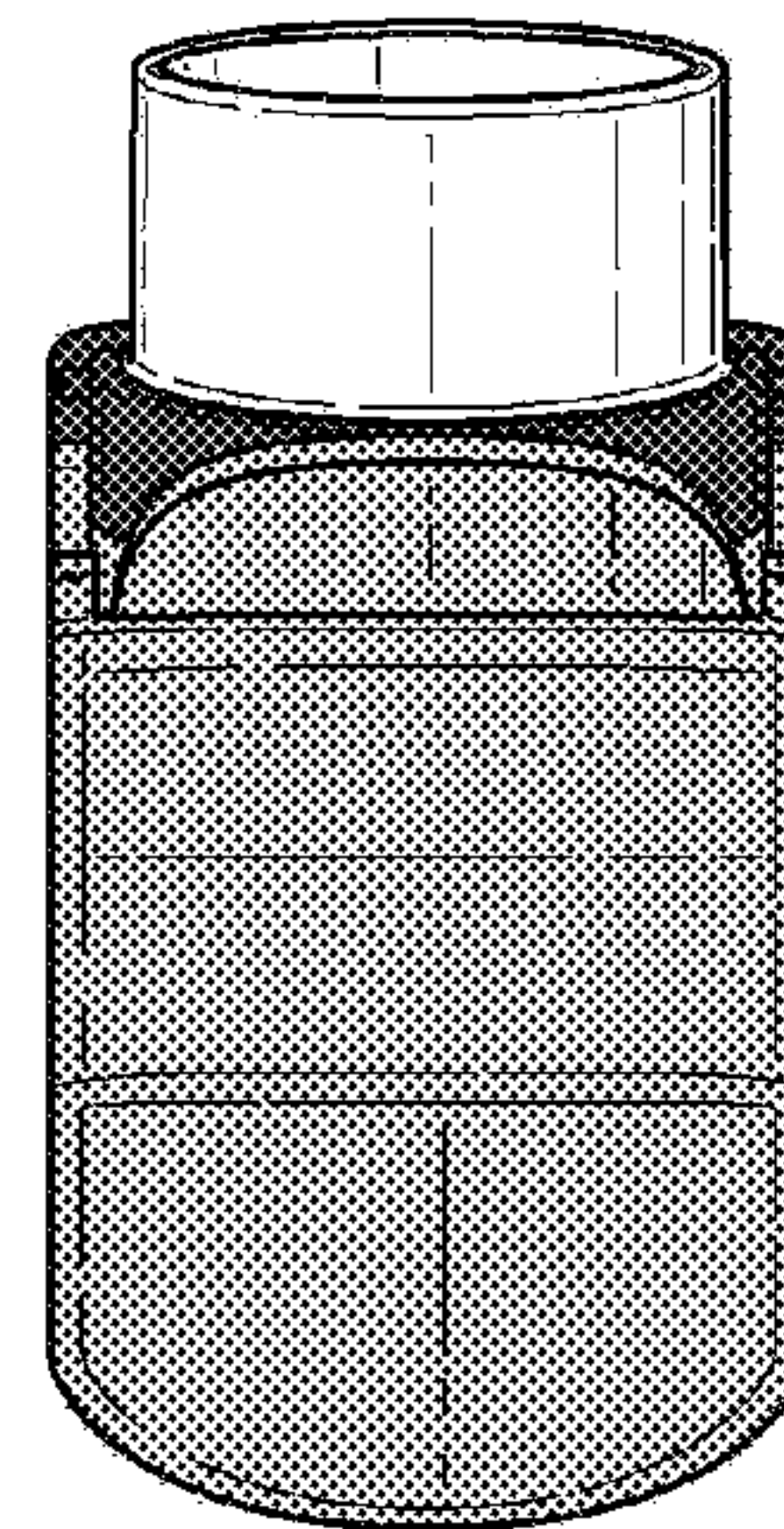

Fig. 35