



US00D716686S

(12) **United States Design Patent**
Dobashi

(10) **Patent No.:** **US D716,686 S**
(45) **Date of Patent:** **** Nov. 4, 2014**

(54) **SETTING**

(71) Applicant: **Crossfor Co., Ltd.**, Yamanashi (JP)

(72) Inventor: **Hidetaka Dobashi**, Yamanashi (JP)

(73) Assignee: **Crossfor Co., Ltd.**, Yamanashi (JP)

(**) Term: **14 Years**

(21) Appl. No.: **29/485,739**

(22) Filed: **Mar. 21, 2014**

(51) **LOC (10) Cl.** **11-01**

(52) **U.S. Cl.**
USPC **D11/92**; D11/91

(58) **Field of Classification Search**
USPC D11/79-86, 90, 91, 92, 1, 2, 40-43, 16,
D11/7; 63/1.11, 18-20, 26-28, 29.1, 29.2,
63/30, 31, 35, 40, 1.16, 1.17; 24/4, 574.1,
24/906

See application file for complete search history.

(56) **References Cited**

U.S. PATENT DOCUMENTS

729,606	A *	6/1903	King	63/27
1,476,462	A *	12/1923	Pejchar	63/26
D131,903	S *	4/1942	Roskin	D11/92
D131,906	S *	4/1942	Roskin	D11/92
2,726,521	A *	12/1955	Melik-Minassiantz	63/27
D187,878	S *	5/1960	Roskin	D11/92
D436,885	S *	1/2001	Manfredi	D11/91
D506,158	S	6/2005	McMullan et al.	
D513,203	S	12/2005	Liechtung	
D513,712	S	1/2006	Koren	
D516,453	S *	3/2006	Kayamori et al.	D11/40
D546,235	S	7/2007	Sabet	
D568,201	S	5/2008	Lai	
D579,372	S	10/2008	Bulgari	
D581,312	S	11/2008	Schumacher	
D602,807	S	10/2009	Colombani et al.	
D610,034	S	2/2010	Colombani	

D634,667	S	3/2011	Papadimitriou	
D666,523	S	9/2012	Dholakiya	
D683,648	S	6/2013	Dholakiya	
2012/0151963	A1 *	6/2012	Dobashi	63/26

OTHER PUBLICATIONS

[online] http://ecx.images-amazon.com/images/I/41in0-GfDfL._SY300_.jpg. Retrieved Sep. 17, 2014.*

* cited by examiner

Primary Examiner — Garth Rademaker

Assistant Examiner — Melanie Pellegrini

(74) *Attorney, Agent, or Firm* — Li & Cai Intellectual Property (USA) Office

(57) **CLAIM**

The ornamental design for a ornament setting, as shown and described.

DESCRIPTION

FIG. 1 is a perspective view of an ornament setting showing my new design;

FIG. 2 is a front view thereof;

FIG. 3 is a rear view thereof;

FIG. 4 is a left side view thereof, the right side view being a mirror image thereto;

FIG. 5 is a top view thereof;

FIG. 6 is a bottom view thereof;

FIG. 7 is a perspective view showing the practical usage thereof;

FIG. 8 is another perspective view showing the practical usage thereof; and,

FIG. 9 is the other perspective view showing the practical usage thereof.

The broken lines depict environmental subject matter only and form no part of the claimed design.

1 Claim, 9 Drawing Sheets

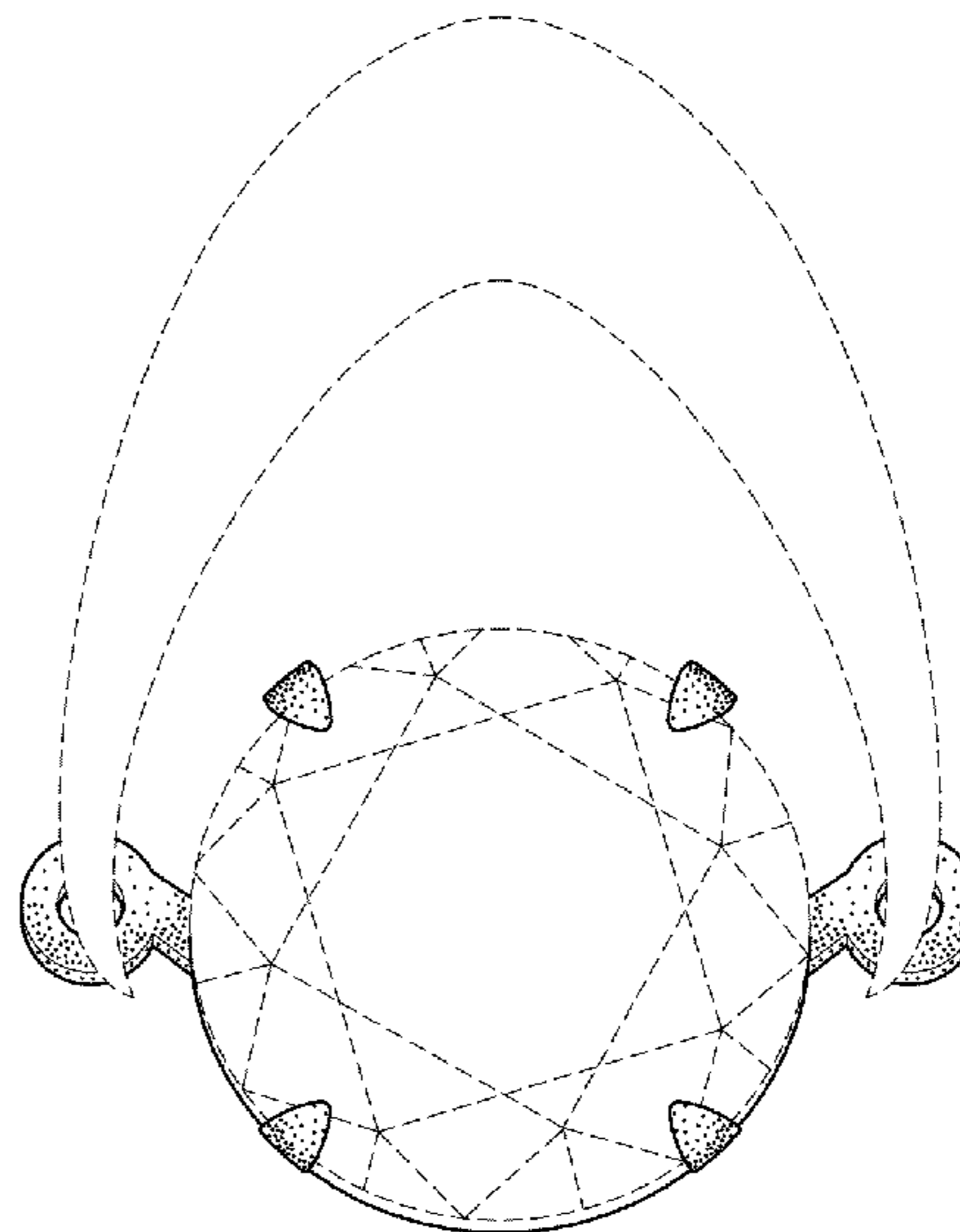
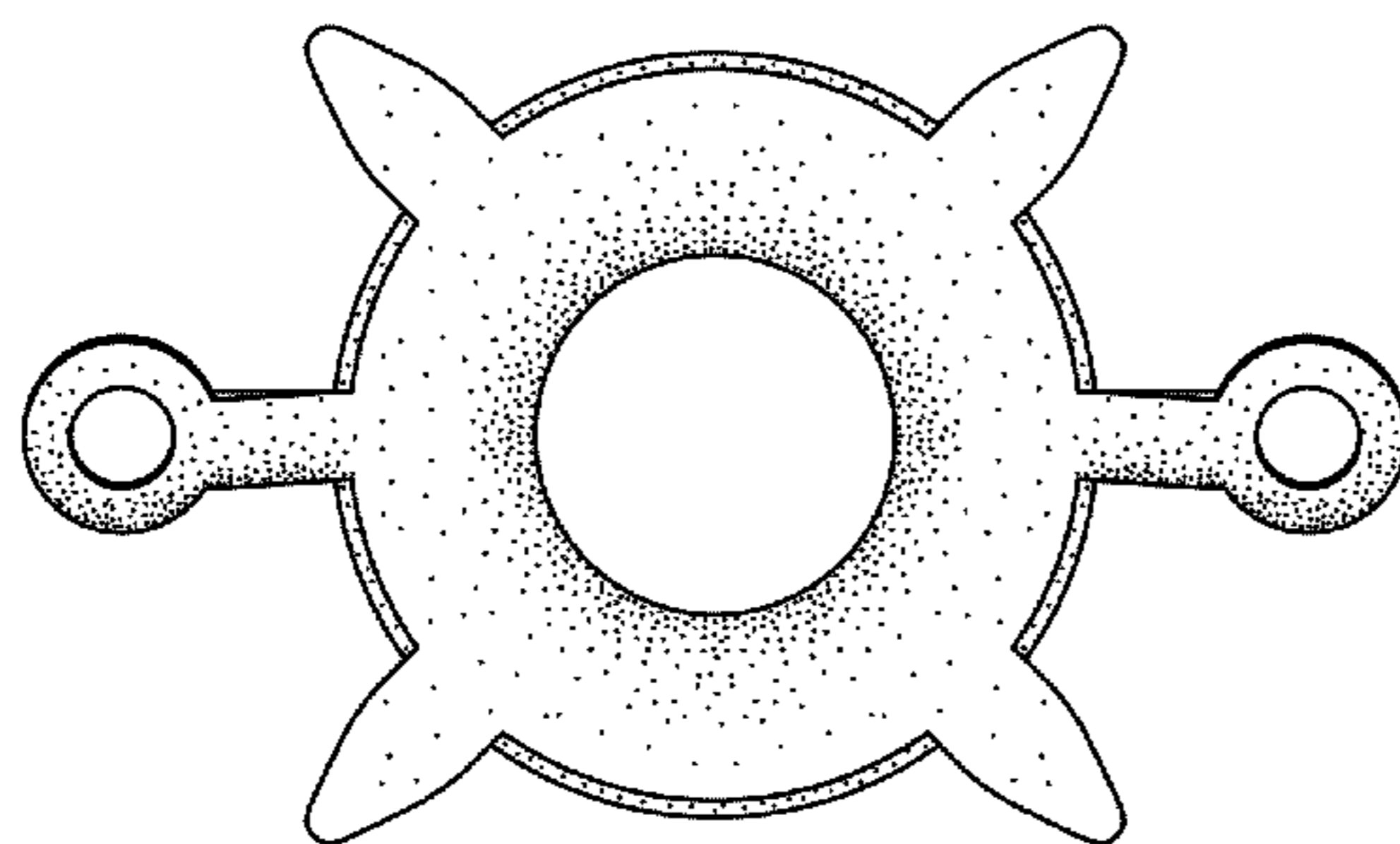

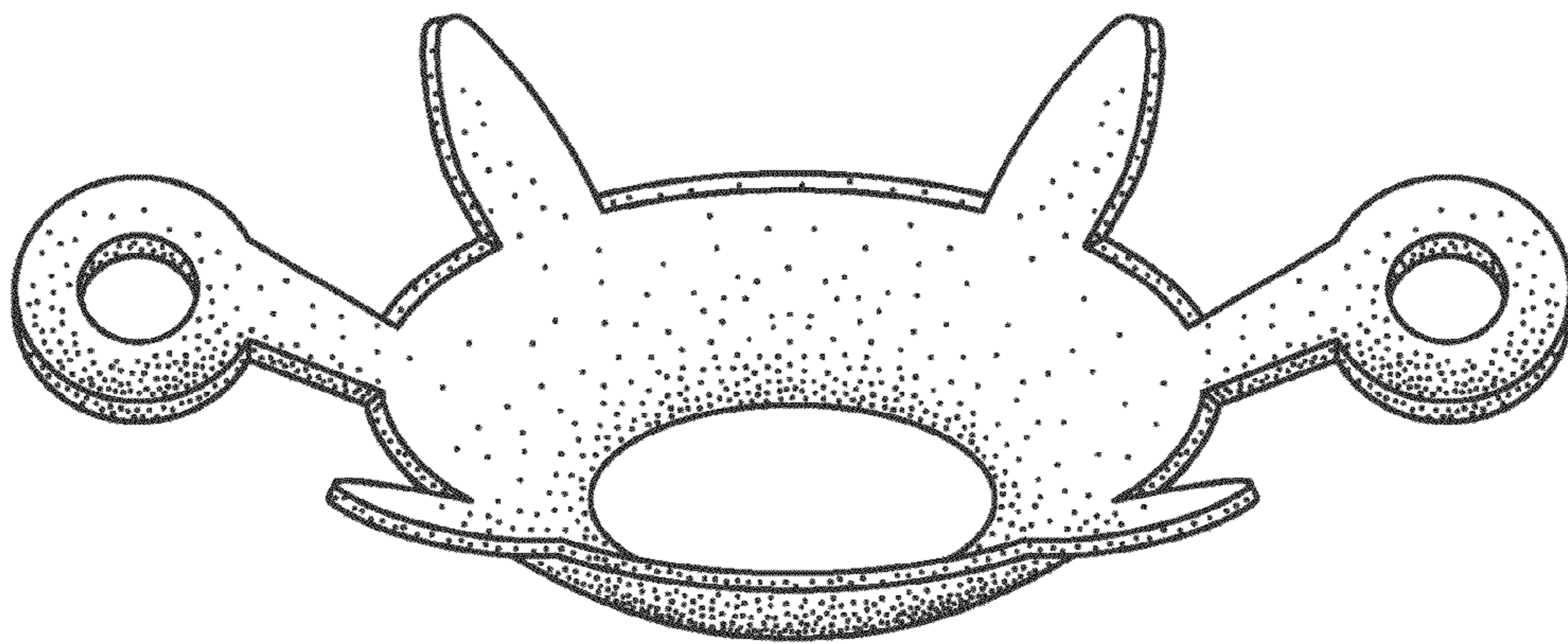

FIG.1

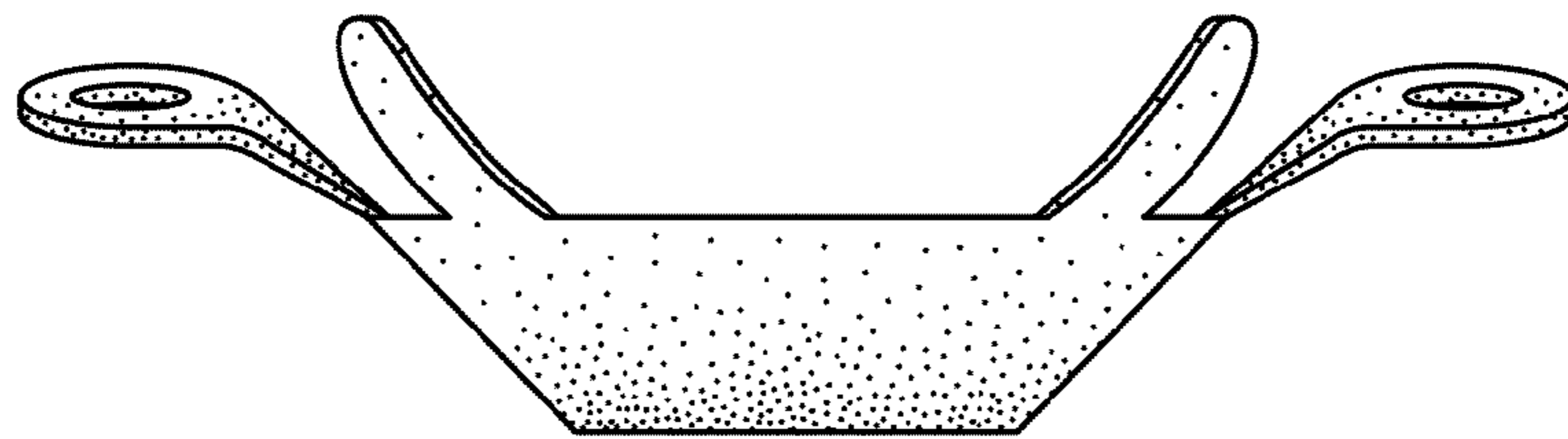

FIG.2

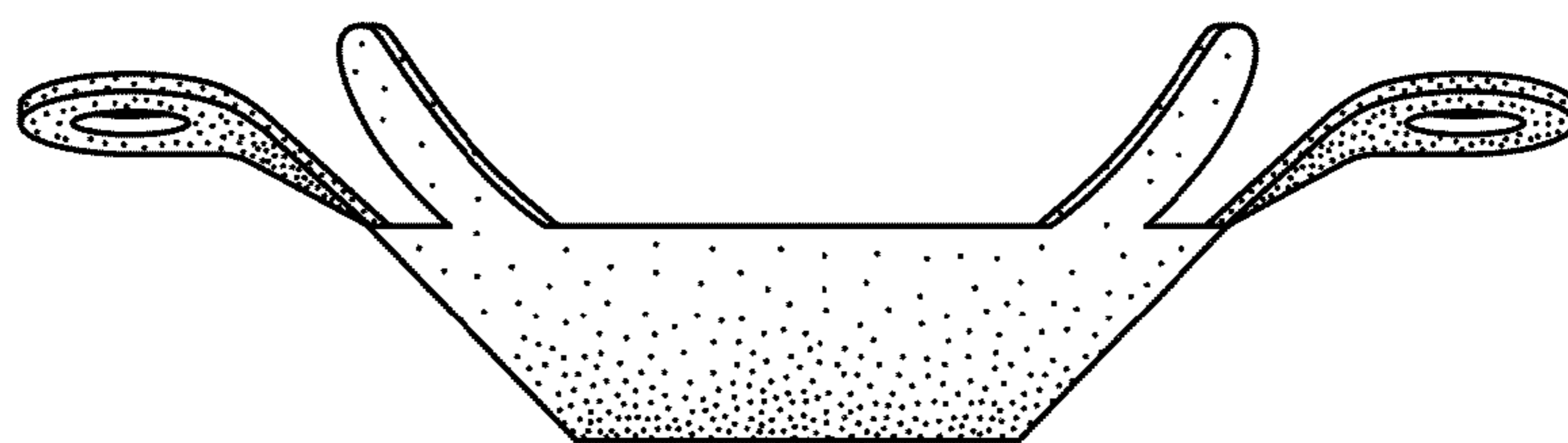

FIG.3

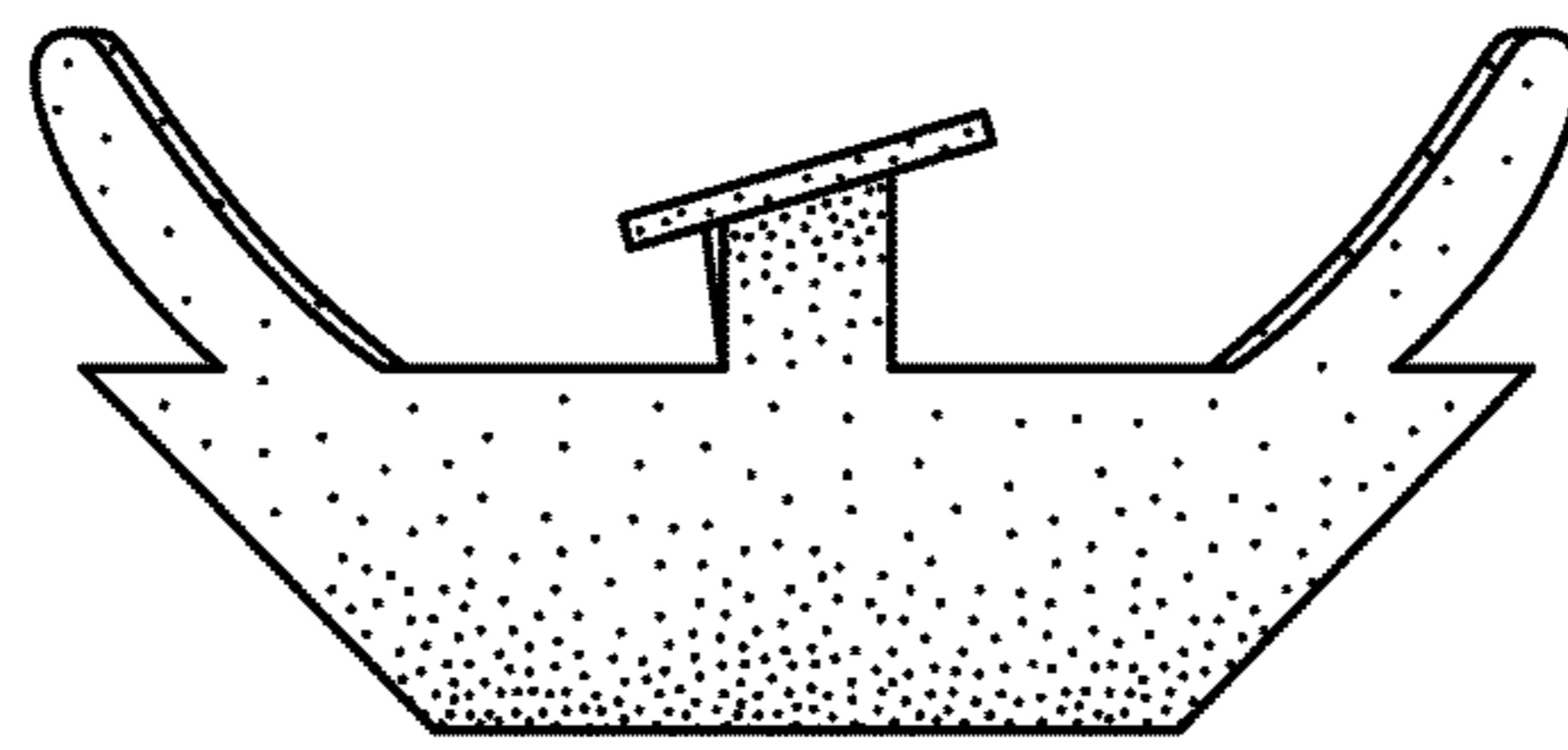

FIG.4

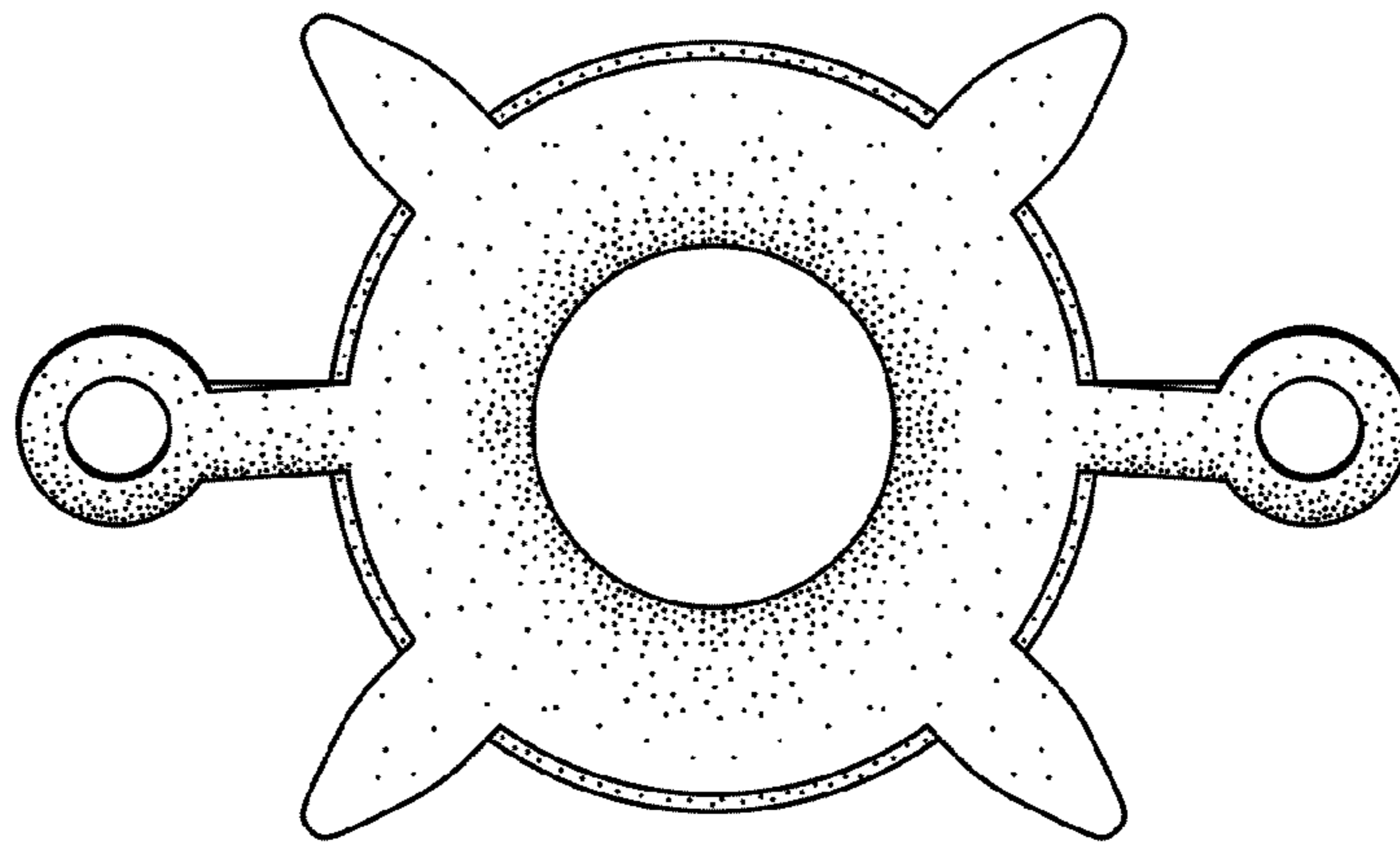

FIG.5

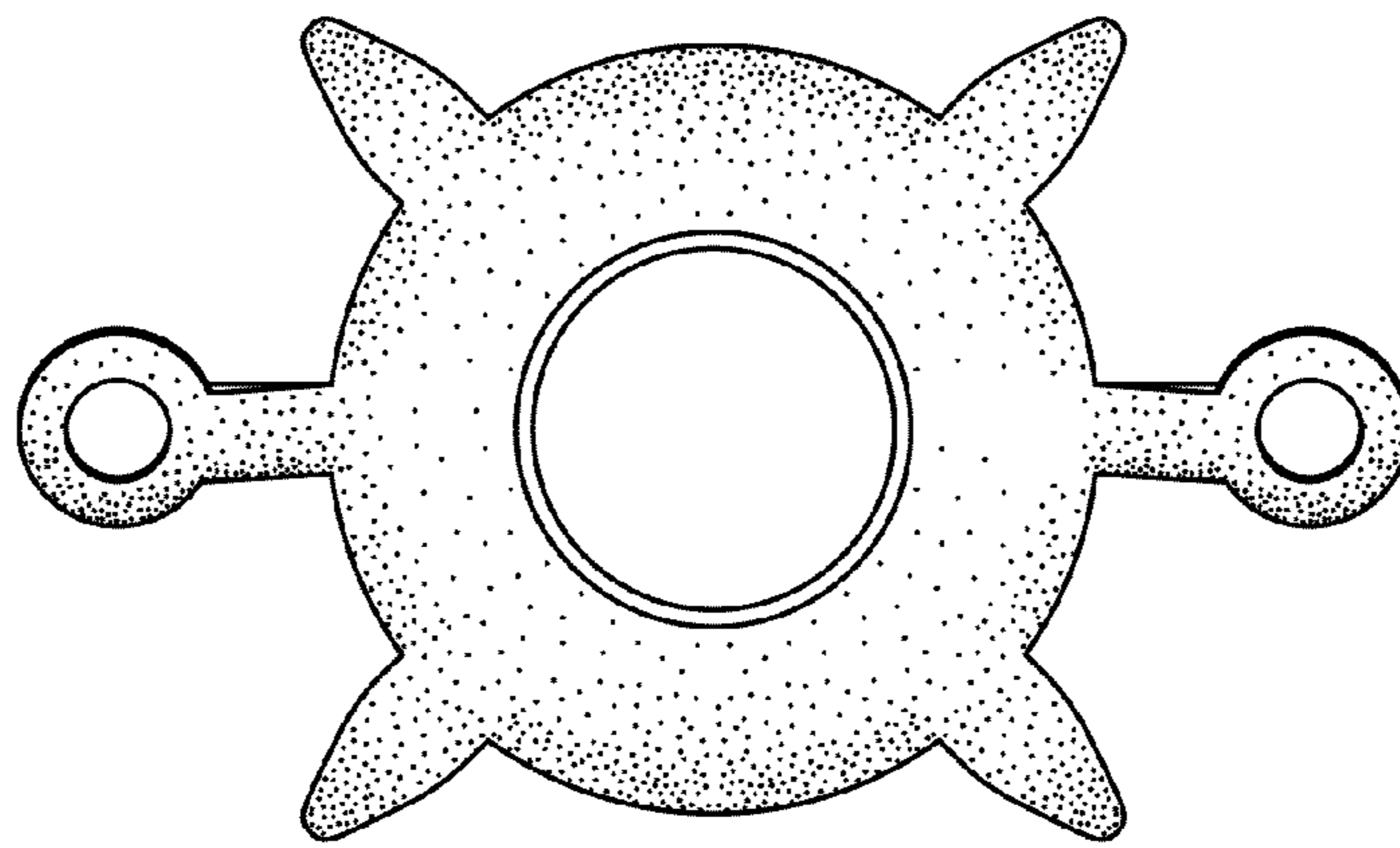

FIG.6

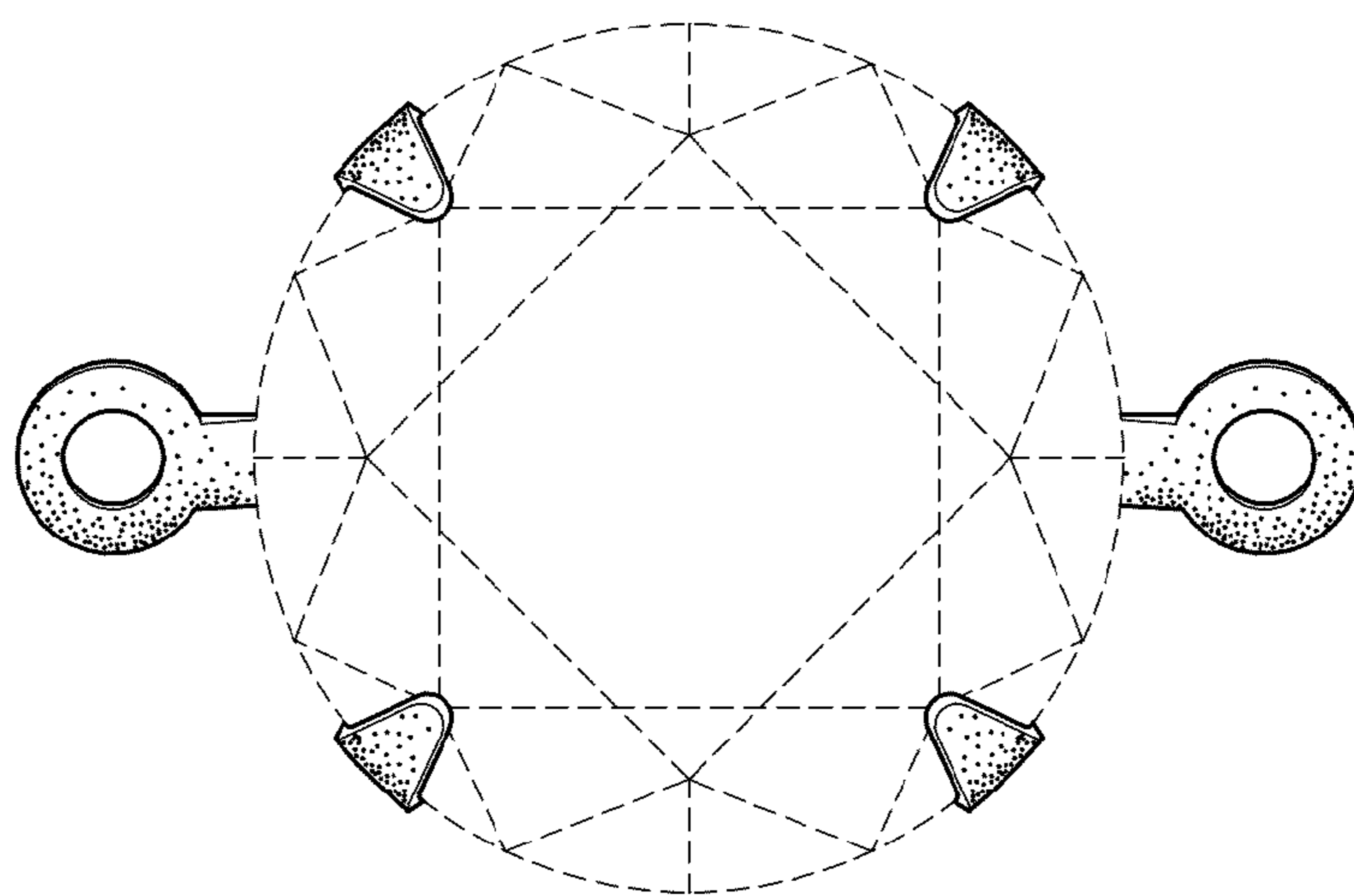

FIG. 7

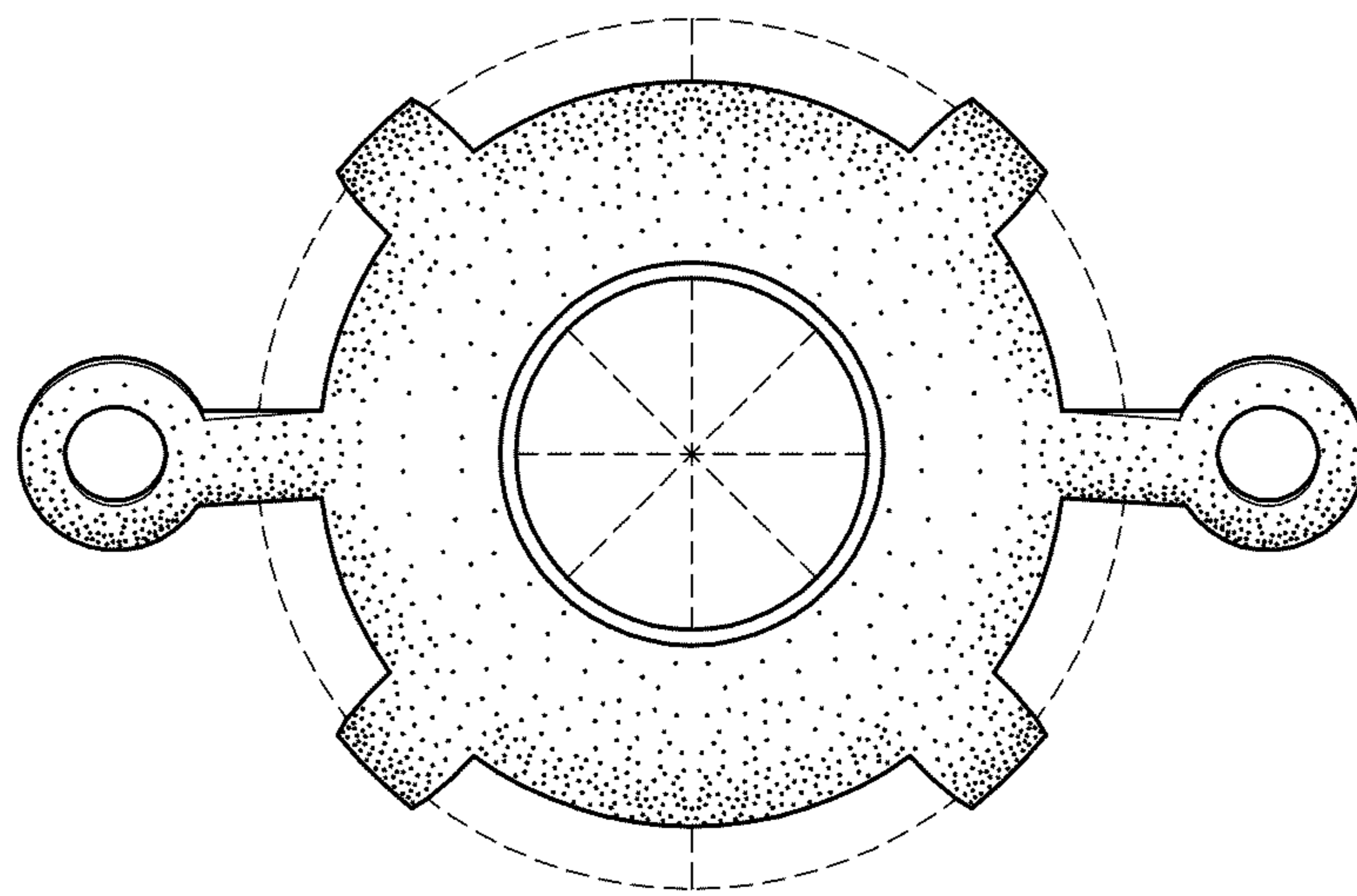

FIG. 8

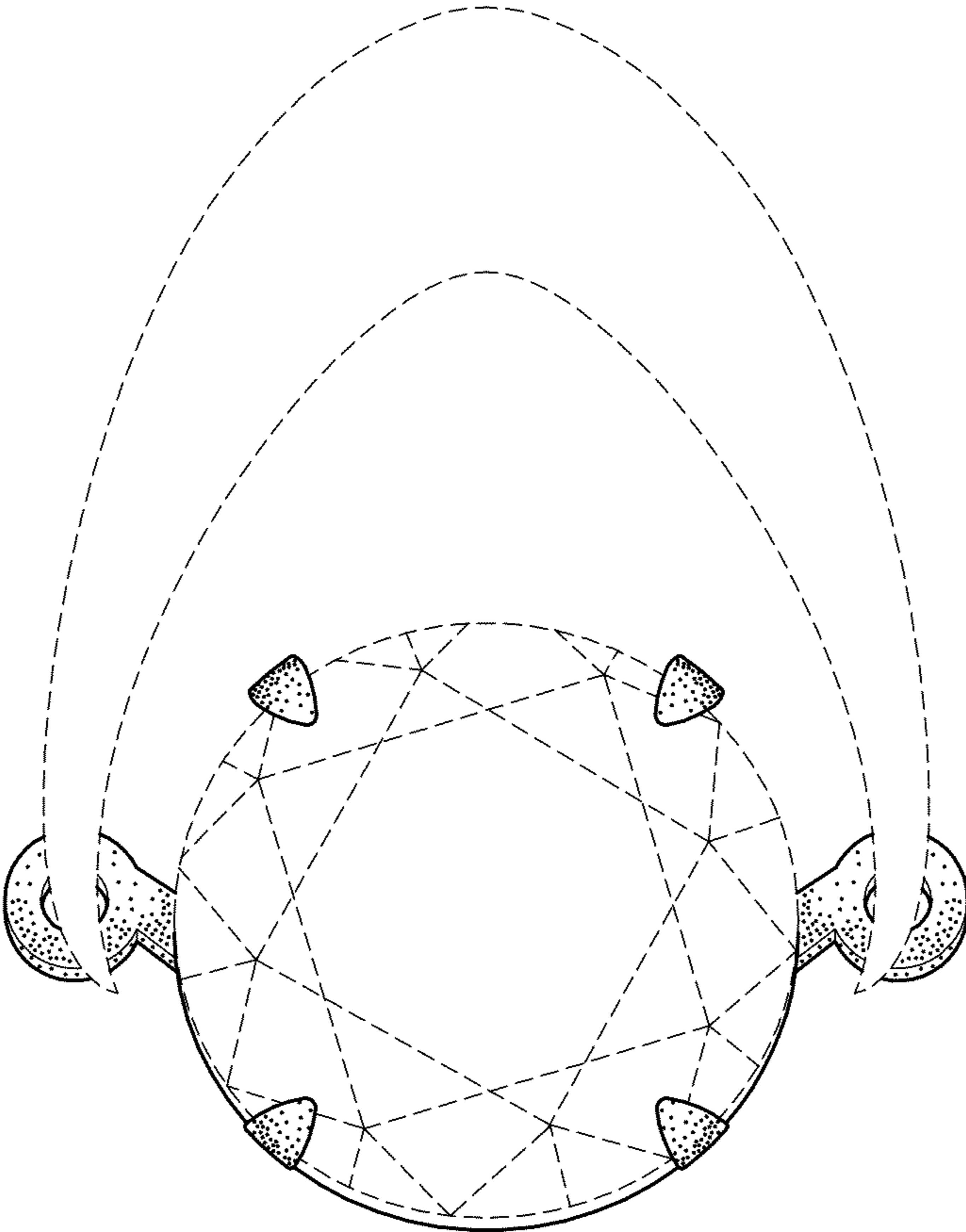

FIG.9