



US00D716672S

(12) **United States Design Patent**
Frivik

(10) **Patent No.:** **US D716,672 S**
(45) **Date of Patent:** **** Nov. 4, 2014**

(54) **QUALITY SENSOR FOR VEHICLES**

141/83, 192, 196; 324/441, 698; 340/438,
340/426.25, 450.2

(71) Applicant: **Wema System AS**, Blomsterdalen (NO)

See application file for complete search history.

(72) Inventor: **Bjorn Erlend Frivik**, Paradis (NO)

(56) **References Cited**

(73) Assignee: **Wema System AS**, Blomsterdalen (NO)

U.S. PATENT DOCUMENTS

(**) Term: **14 Years**

3,223,241 A * 12/1965 Kasten 210/96.1
6,826,950 B2 * 12/2004 Lecea et al. 73/114.38

(21) Appl. No.: **29/454,877**

* cited by examiner

(22) Filed: **Jun. 4, 2013**

Primary Examiner — Antoine D Davis

(30) **Foreign Application Priority Data**

(74) *Attorney, Agent, or Firm* — Fredrikson & Byron, P.A.

Nov. 20, 2012 (NO) 20120965

(51) **LOC (10) Cl.** **10-04**

(57) **CLAIM**

I claim the ornamental design for a quality sensor for vehicles,
as shown and described.

(52) **U.S. Cl.**

DESCRIPTION

USPC **D10/53**

(58) **Field of Classification Search**

CPC F02D 19/0628; F02D 19/0684; F02D
19/0634; F02D 19/084; F02D 41/0025;
F02M 65/00; F02M 69/465; F02M 55/025;
F02M 2200/14; F02M 2200/0611

USPC D10/96, 97, 101, 102; 73/61.43,
73/114.38, 114.52–114.54, 114.68,
73/114.71–114.73, 114.43, 149;
123/406.3, 1 A, 685, 406.47,
123/406.37–406.39, 406.45; 141/94, 95,

FIG. 1 is a perspective view of a quality sensor for vehicles
showing my new design;
FIG. 2 is a front view thereof;
FIG. 3 is a back view thereof;
FIG. 4 is a left side view thereof;
FIG. 5 is a right side view thereof;
FIG. 6 is top view thereof; and,
FIG. 7 is a bottom view thereof.

1 Claim, 6 Drawing Sheets

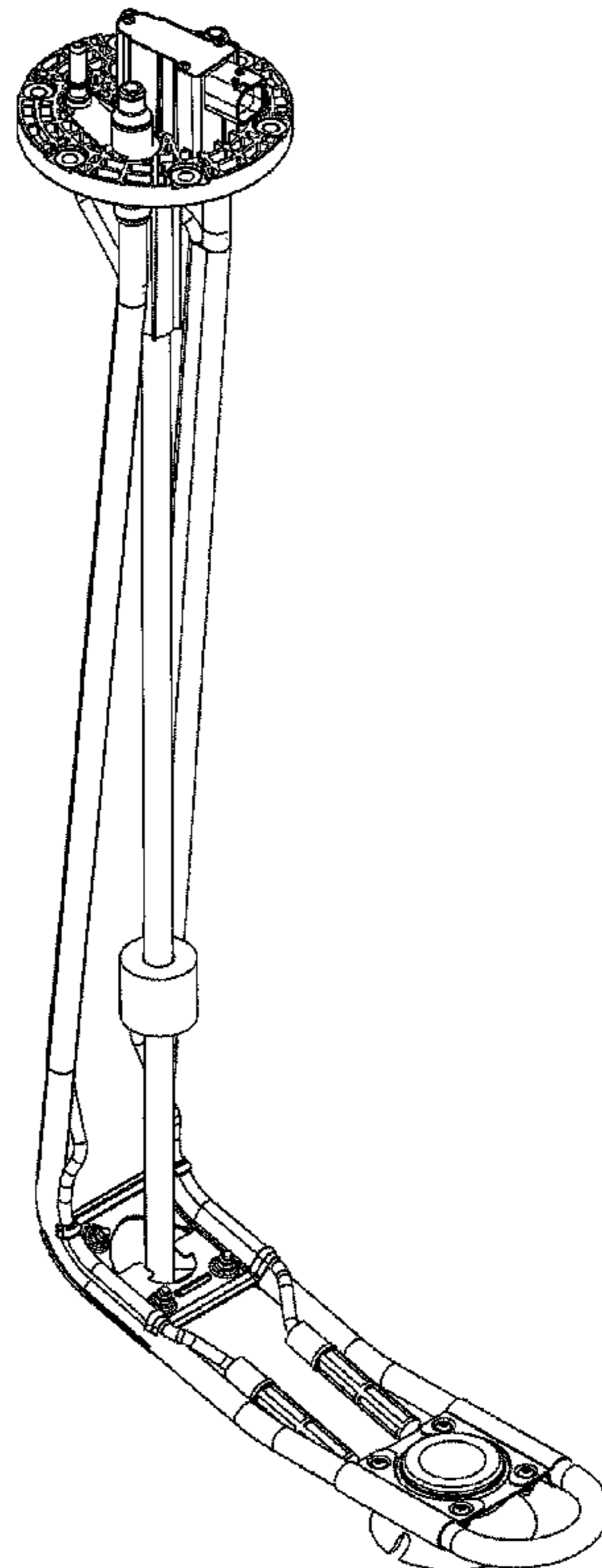

Fig. 1

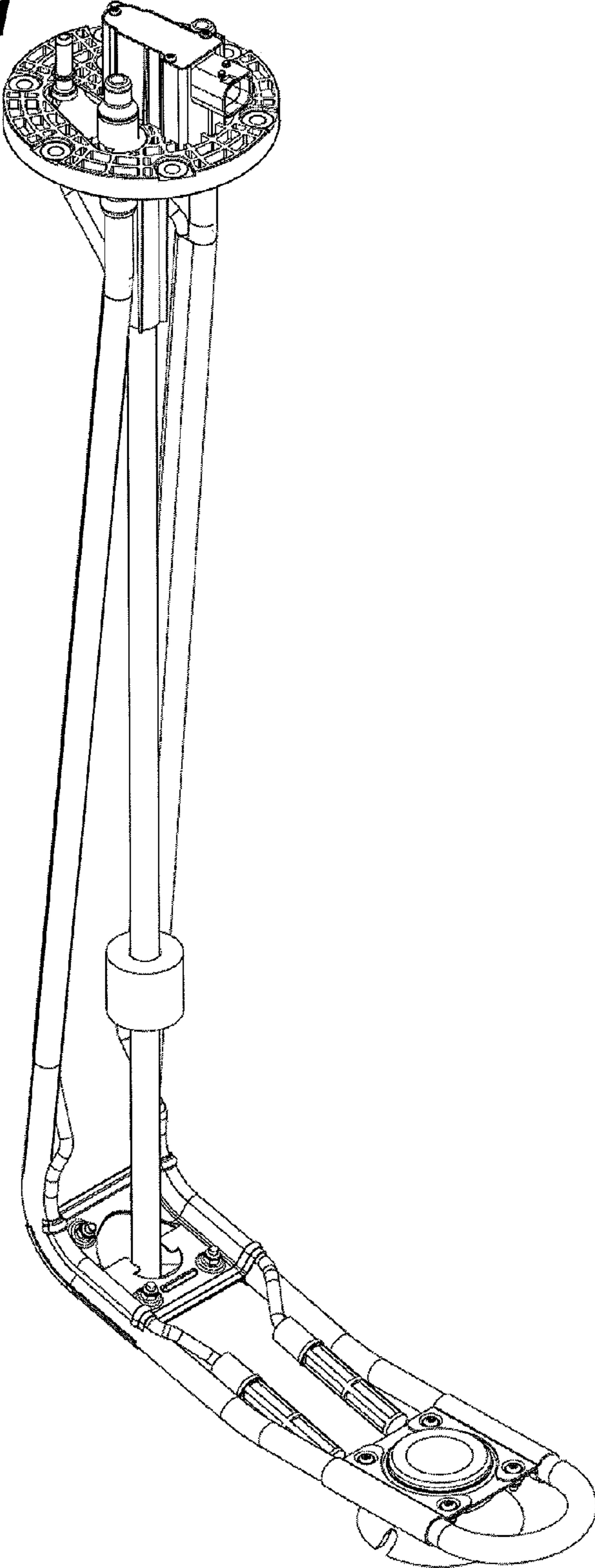

Fig. 2

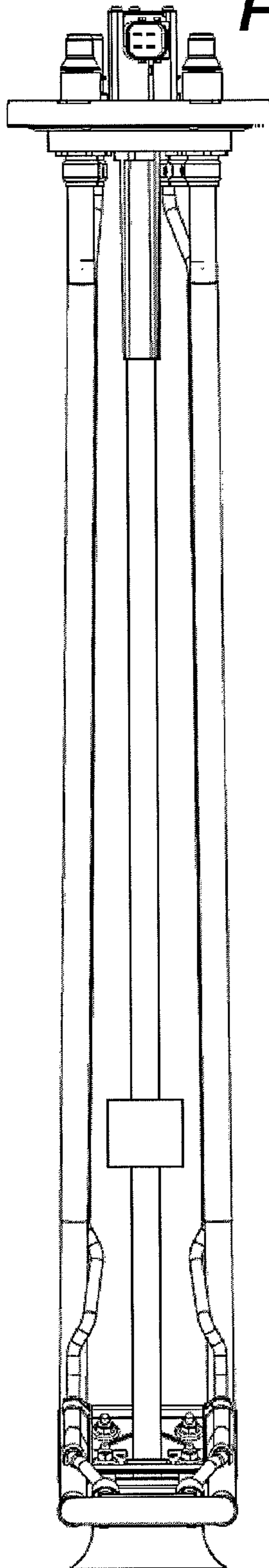

Fig. 3

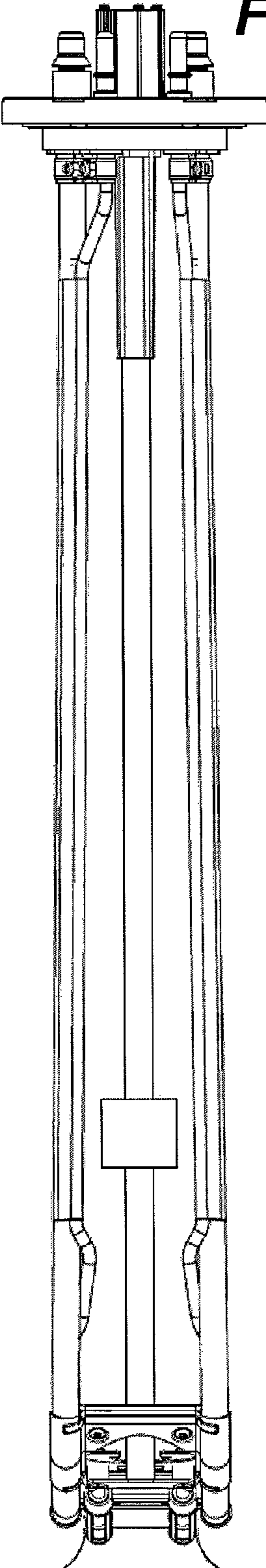

Fig. 4

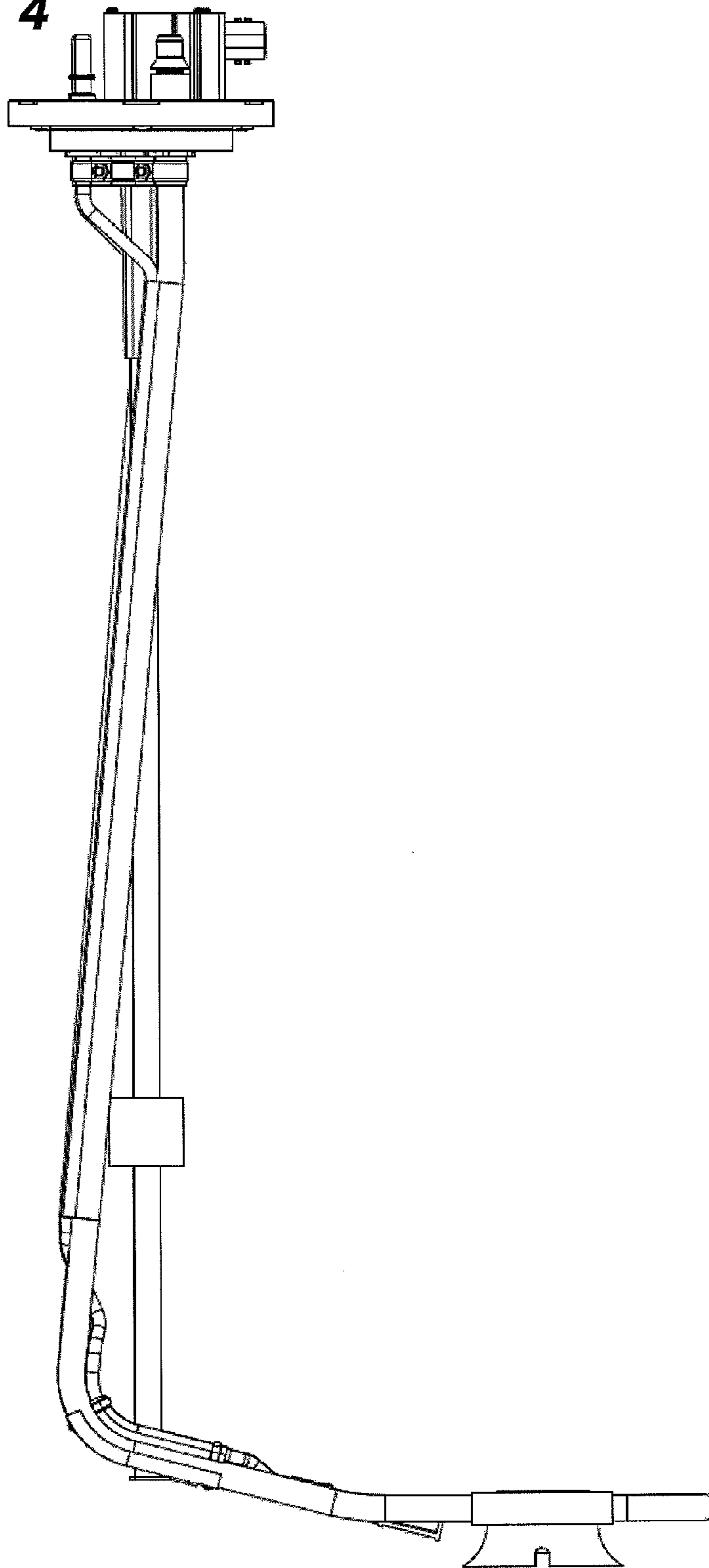

Fig. 5

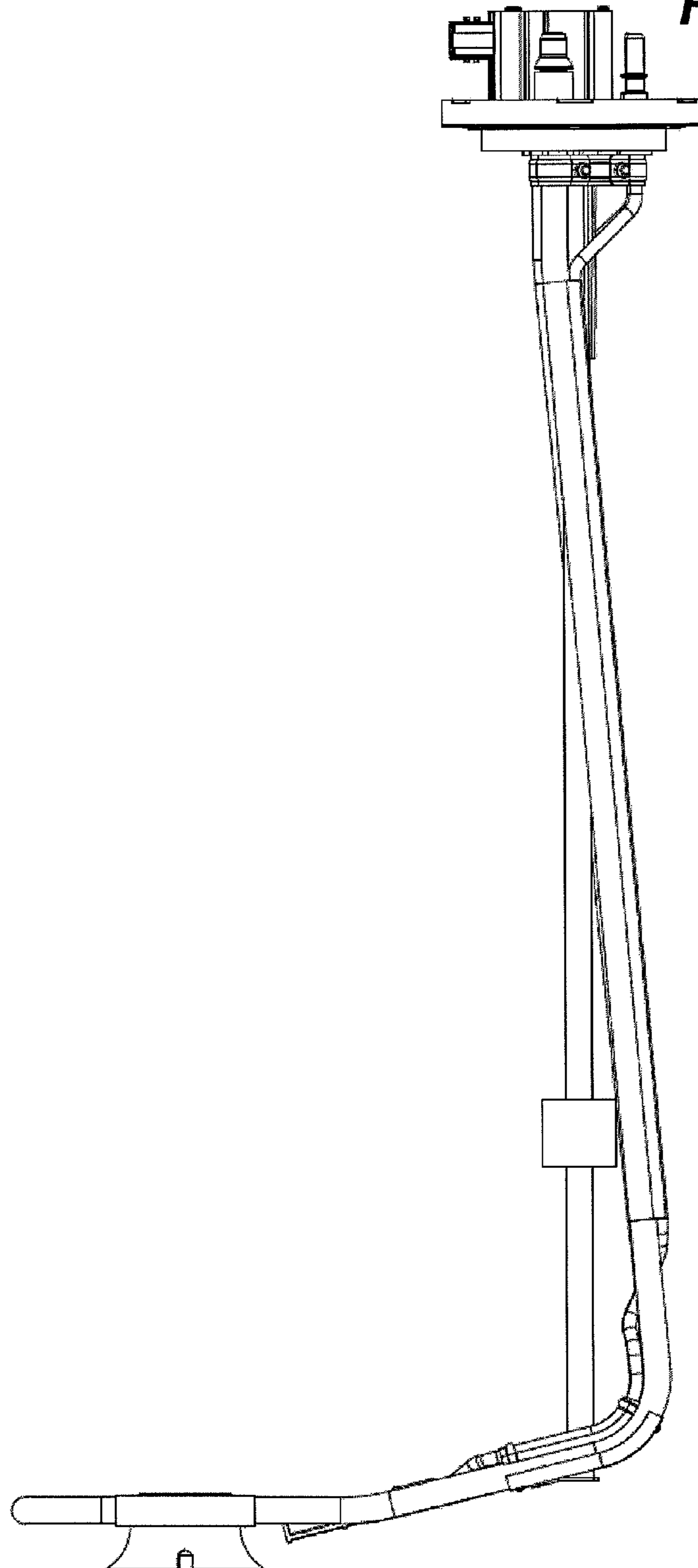

Fig. 6

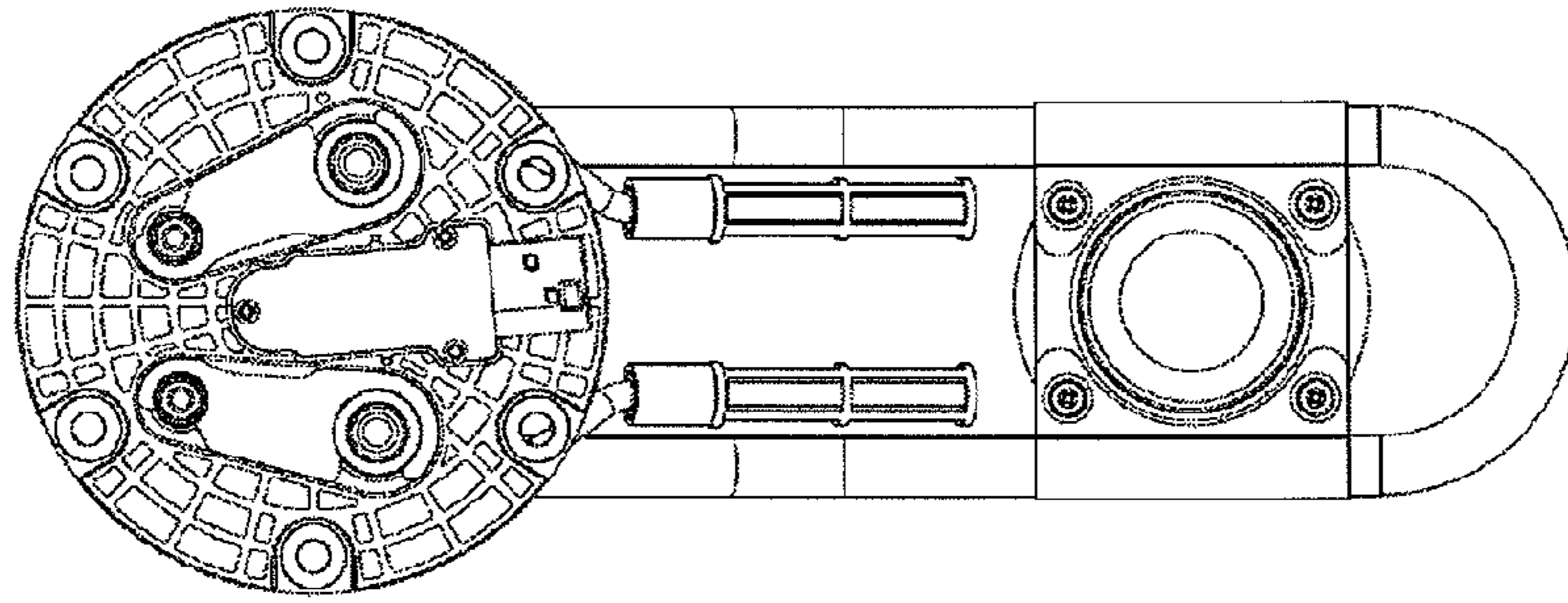

Fig. 7

