



US00D716666S

(12) **United States Design Patent**  
**Park**

(10) **Patent No.:** **US D716,666 S**

(45) **Date of Patent:** **\*\* Nov. 4, 2014**

(54) **COSMETIC CONTAINER**

(71) Applicant: **Amorepacific Corporation**, Seoul (KR)

(72) Inventor: **Kyung Mi Park**, Seoul (KR)

(73) Assignee: **Amorepacific Corporation**, Seoul (KR)

(\*\*) Term: **14 Years**

(21) Appl. No.: **29/462,170**

(22) Filed: **Jul. 31, 2013**

(30) **Foreign Application Priority Data**

Feb. 1, 2013 (KR) ..... 30-2013-0005708

(51) **LOC (10) Cl.** ..... **09-01**

(52) **U.S. Cl.**  
USPC ..... **D9/690**

(58) **Field of Classification Search**  
USPC ..... D9/682-694, 500-505, 519, 544-546,  
D9/549-558, 434-436, 439, 445, 448,  
D9/454; 215/379, 382; 220/376, 377, 662,  
220/665, 669; 222/153.11, 153.12, 153.13,  
222/153.14, 173, 182, 183, 321.1, 321.6, 3,  
222/21.7, 321.8, 325-327, 372, 378, 382,  
222/383.1, 402.11, 402.13

See application file for complete search history.

(56) **References Cited**

**U.S. PATENT DOCUMENTS**

842,097	A	*	1/1907	Jahn	.....	239/349
D48,265	S	*	12/1915	Schofield	.....	D9/526
D215,698	S	*	10/1969	Jordan et al.	.....	D9/688
D218,553	S	*	9/1970	Nigro	.....	D9/688
D236,684	S	*	9/1975	Hebblethwaite	.....	D9/690
D242,120	S	*	11/1976	Berenstein	.....	D9/688
D351,337	S	*	10/1994	Bonnema et al.	.....	D9/690
D385,793	S	*	11/1997	Marsal	.....	D9/503
D394,389	S	*	5/1998	Kudo	.....	D9/545
D402,549	S	*	12/1998	Nahum Albright	.....	D9/545
D463,743	S	*	10/2002	de Mourgues	.....	D9/448
D463,746	S	*	10/2002	de Baschmakoff	.....	D9/500

D476,224	S	*	6/2003	de Baschmakoff et al.	...	D9/692
D511,690	S	*	11/2005	Garcia et al.	.....	D9/682
D541,169	S	*	4/2007	Ball et al.	.....	D9/690
D584,638	S	*	1/2009	Castelnuovo-Tedesco	....	D9/686
D613,604	S	*	4/2010	Rowland et al.	.....	D9/504
D613,614	S	*	4/2010	Rodriguez et al.	.....	D9/689
7,874,461	B2	*	1/2011	Bae	.....	222/153.13
8,308,029	B2	*	11/2012	Ki	.....	222/309
D675,105	S	*	1/2013	Chen	.....	D9/688
D679,998	S	*	4/2013	Kim	.....	D9/448
D688,138	S	*	8/2013	Kim	.....	D9/690
D696,963	S	*	1/2014	Chen	.....	D9/688

**FOREIGN PATENT DOCUMENTS**

KR	00401528.0000	*	12/2005
KR	300538652.0000	*	9/2009
KR	300538690.0000	*	9/2009

\* cited by examiner

*Primary Examiner* — Catherine Tuttle

(74) *Attorney, Agent, or Firm* — Ohlandt, Greeley, Ruggiero & Perle, L.L.P.

(57) **CLAIM**

The ornamental design for a cosmetic container, as shown and described.

**DESCRIPTION**

FIG. 1 is a perspective view of the cosmetic container of the present disclosure;

FIG. 2 is a front elevation view of the cosmetic container shown in FIG. 1;

FIG. 3 is a rear elevation view of the cosmetic container shown in FIG. 1;

FIG. 4 is a left side elevation view of the cosmetic container shown in FIG. 1;

FIG. 5 is a right side elevation view of the cosmetic container shown in FIG. 1;

FIG. 6 is a top plan view of the cosmetic container shown in FIG. 1; and,

FIG. 7 is a bottom plan view of the cosmetic container shown in FIG. 1.

**1 Claim, 7 Drawing Sheets**

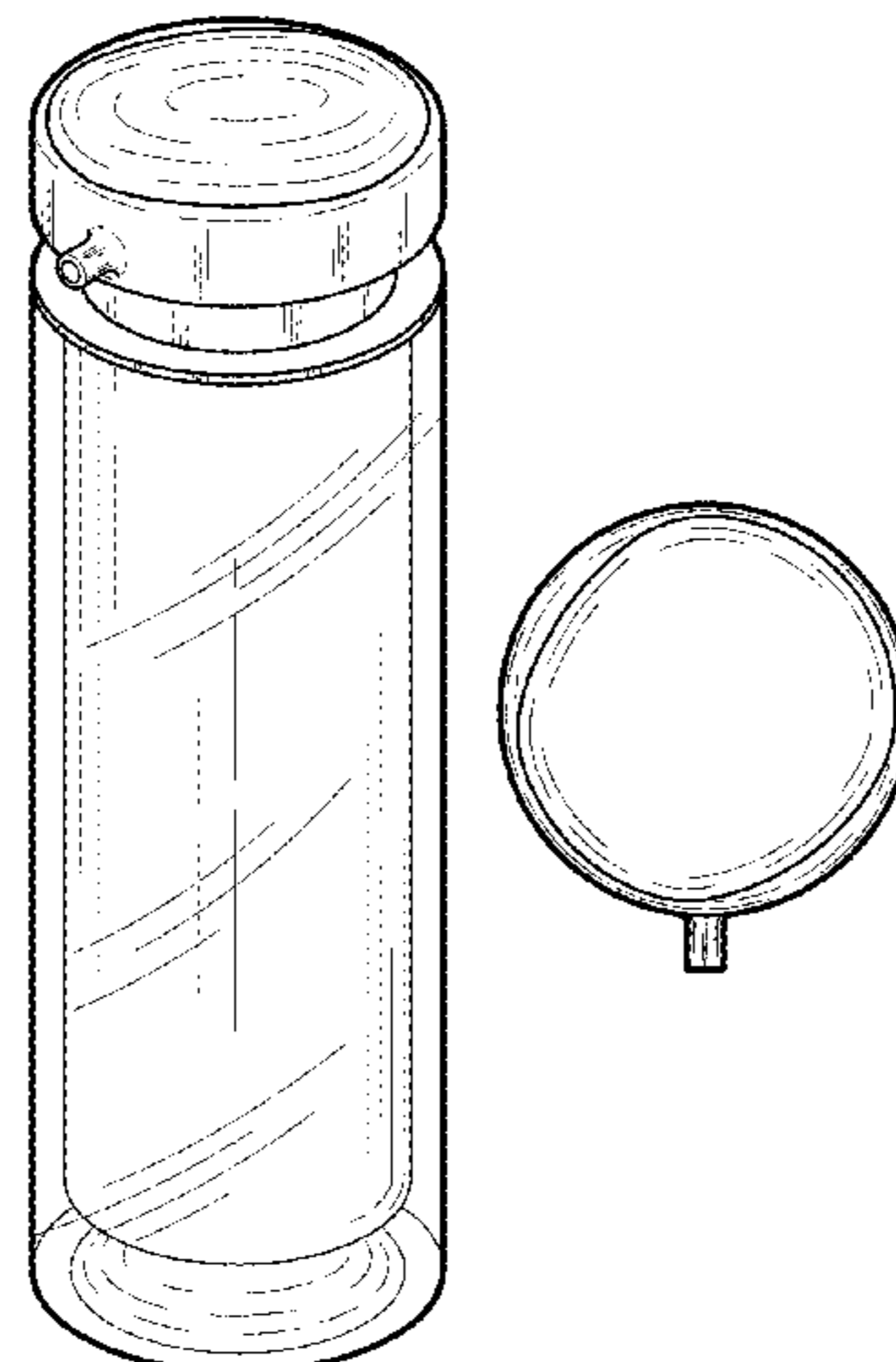

FIG. 1

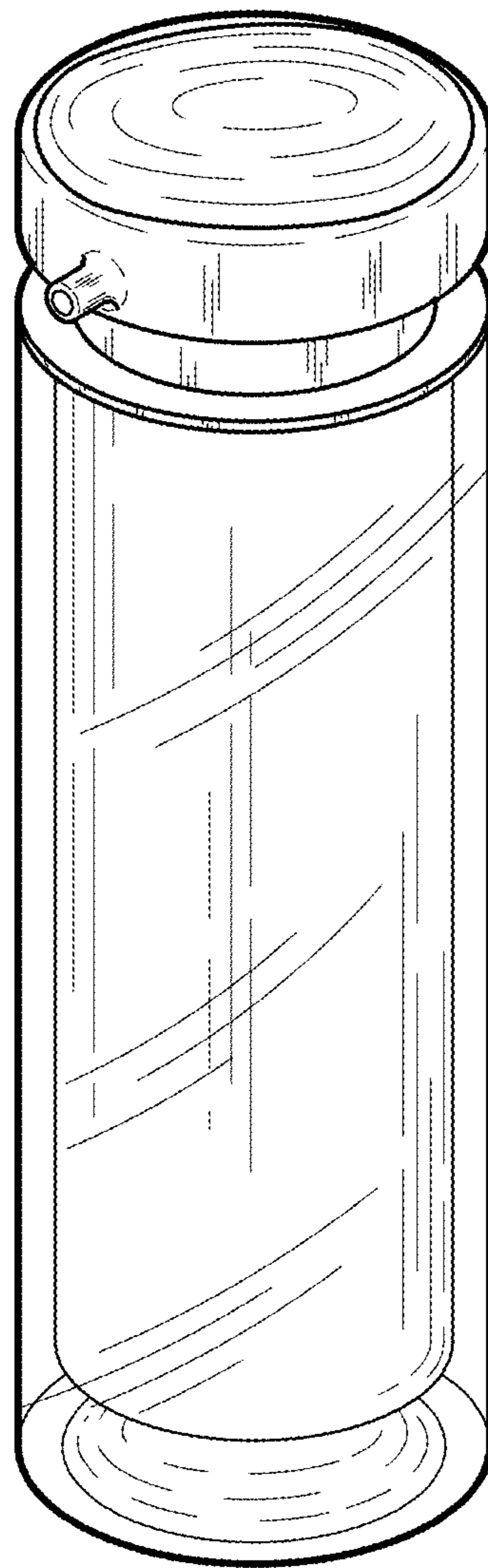

FIG. 2

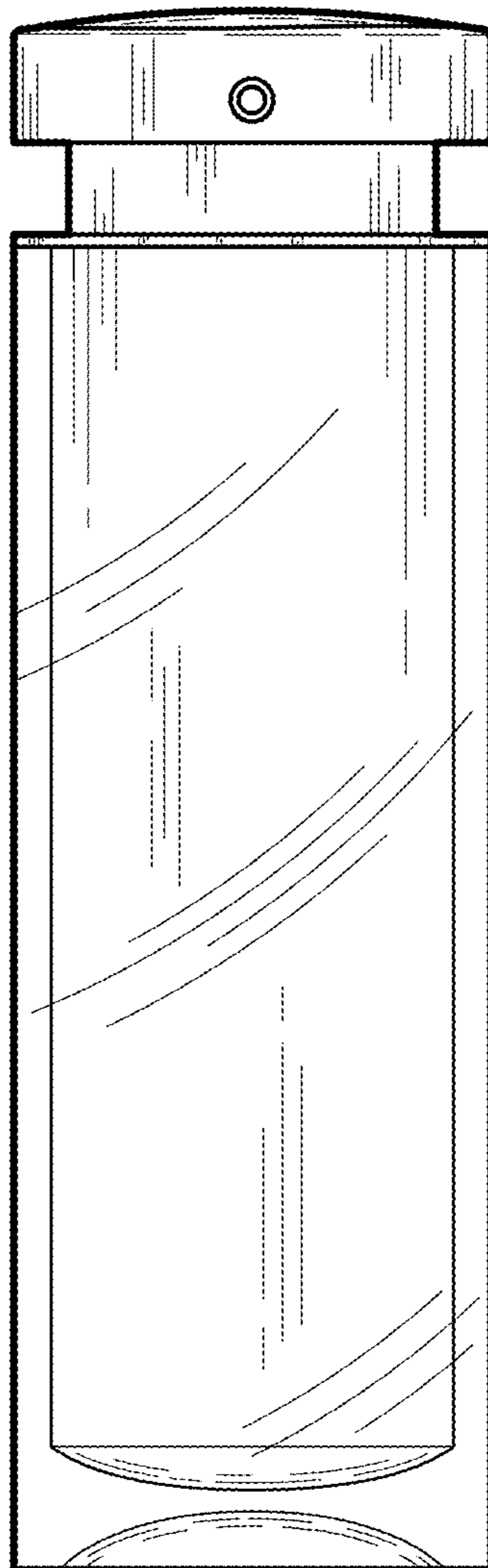

FIG. 3

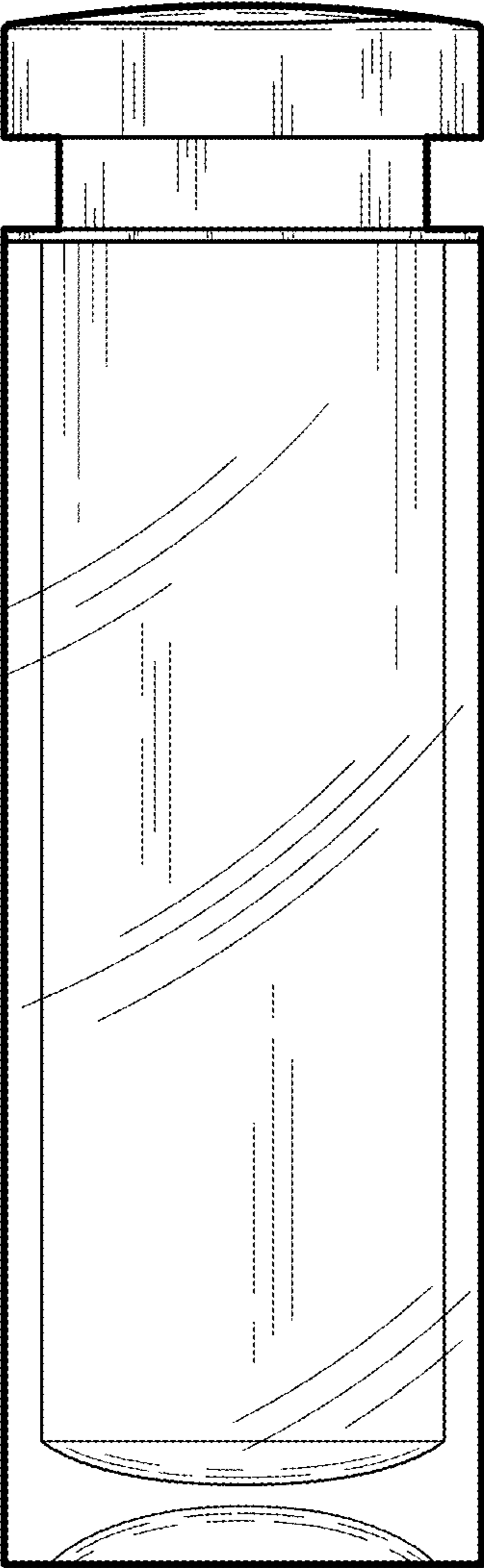

FIG. 4

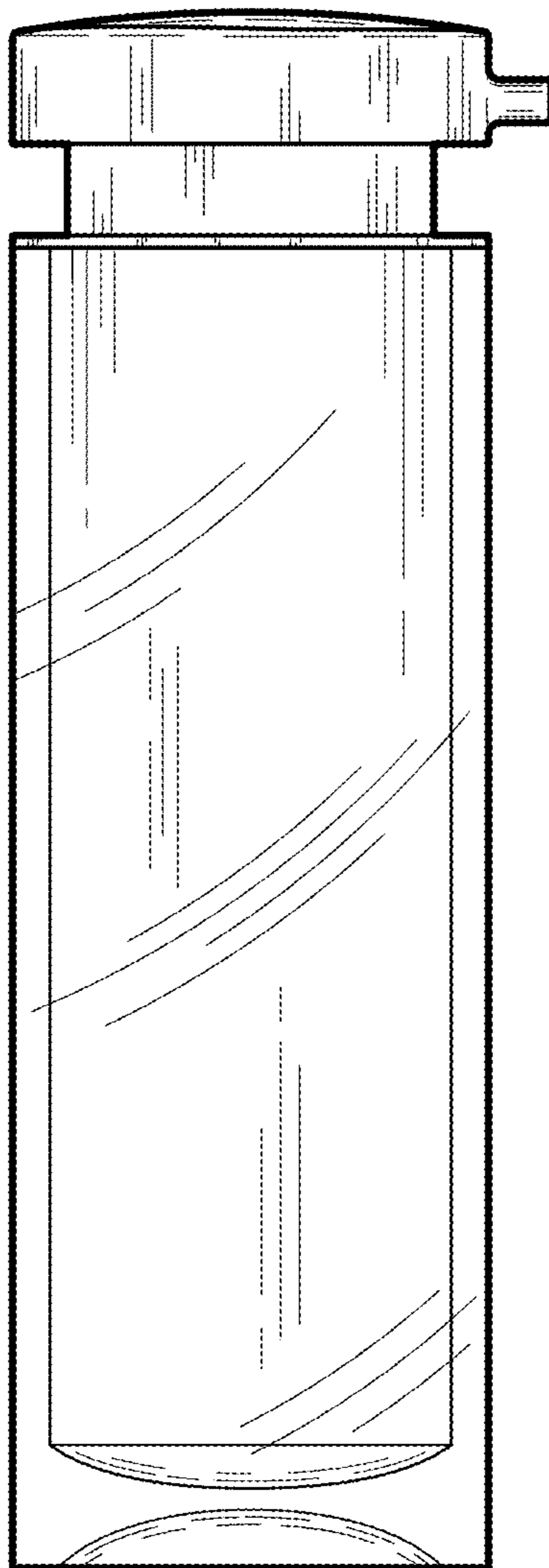

FIG. 5

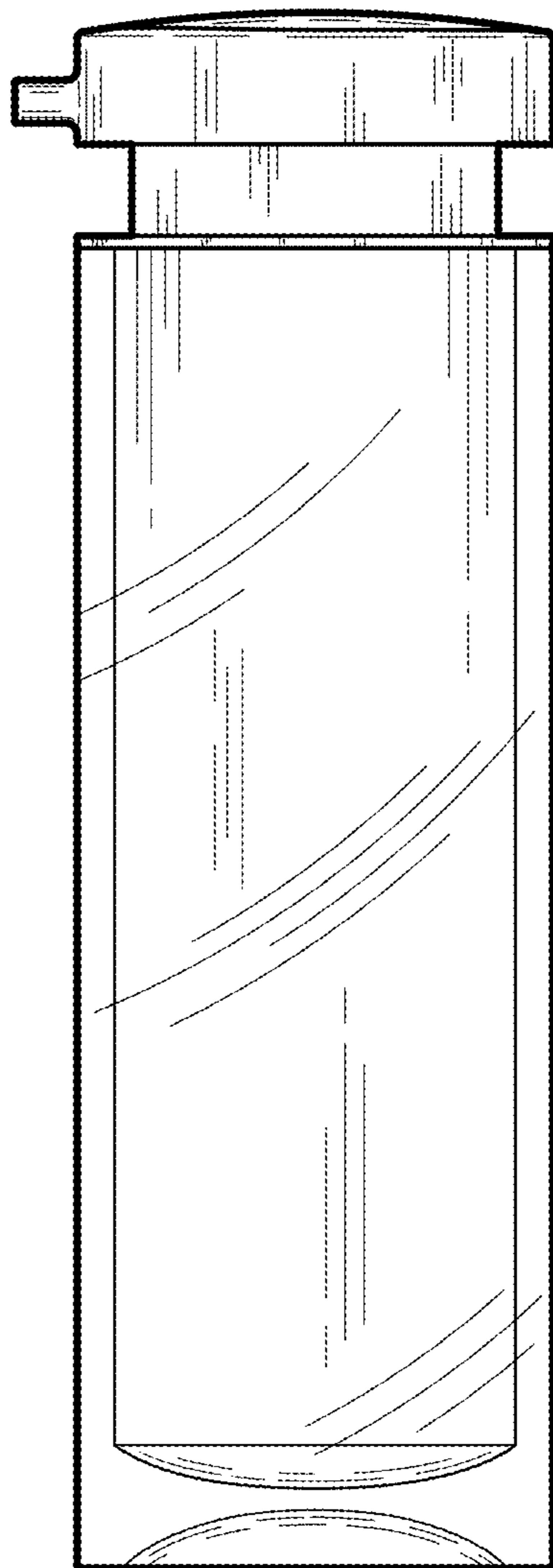

FIG. 6

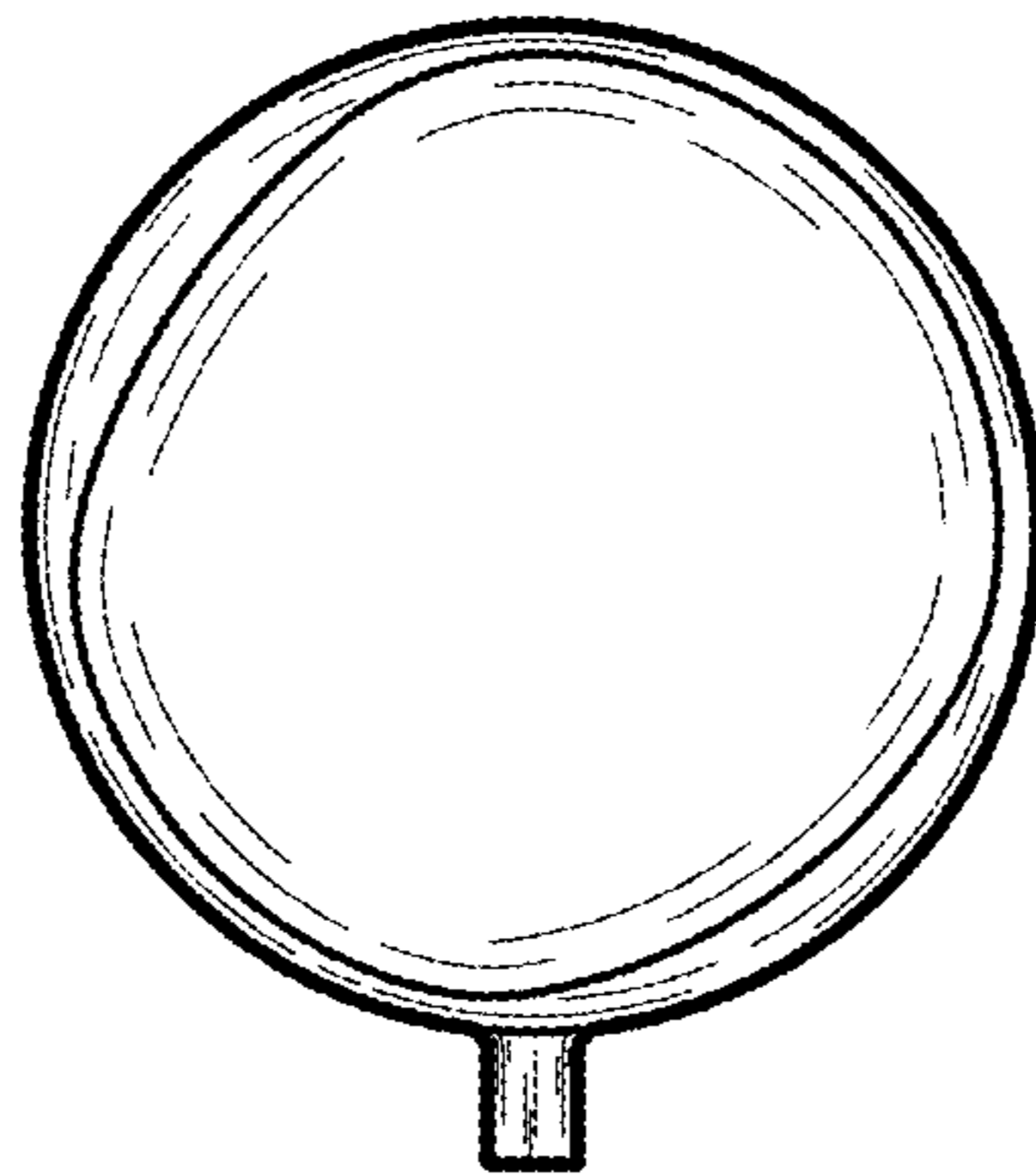

FIG. 7

