



US00D716596S

(12) **United States Design Patent**  
**Pedersen et al.**

(10) **Patent No.:** **US D716,596 S**  
(45) **Date of Patent:** **\*\* Nov. 4, 2014**

- (54) **TABLE BASE**
- (71) Applicant: **Target Brands, Inc.**, Minneapolis, MN (US)
- (72) Inventors: **Sara L. Pedersen**, Minneapolis, MN (US); **Katherine R. Wittenberg**, St. Paul, MN (US); **Chad M. Bogdan**, St. Paul, MN (US); **George K. Smithwick**, Blaine, MN (US)
- (73) Assignee: **Target Brands, Inc.**, Minneapolis, MN (US)
- (\*\*) Term: **14 Years**
- (21) Appl. No.: **29/482,749**
- (22) Filed: **Feb. 21, 2014**

- D386,332 S 11/1997 Grosfillex
- D402,487 S 12/1998 Muller
- D412,257 S 7/1999 Mendoza
- D439,446 S 3/2001 Harrison
- 7,694,635 B2 \* 4/2010 Bernheimer et al. .... 108/153.1
- D702,468 S \* 4/2014 Pedersen et al. .... D6/708

**OTHER PUBLICATIONS**

Agio Charleston Furniture Set, photographs taken at Costco Wholesale Corporation on Feb. 21, 2010, 4 pages.  
Home Furniture Review, "Outdoor Patio Home Bromley Tan Metal Sling Rectangular Dining Set," 1 page, <http://homefurniturereview.com/outdoor-patio-home-bromley-tan-metal-sling-5-pc-rectangular-dining-set.html>, at least as early as Aug. 2012.

(Continued)

*Primary Examiner* — Janice Seeger

(74) *Attorney, Agent, or Firm* — Leanne Taveggia Farrell; Westman Champlin & Koehler, P.A.

**Related U.S. Application Data**

(62) Division of application No. 29/438,926, filed on Dec. 5, 2012, now Pat. No. Des. 702,468.

(51) **LOC (10) Cl.** ..... **06-06**

(52) **U.S. Cl.**  
USPC ..... **D6/708**

(58) **Field of Classification Search**  
USPC ..... D6/691, 691.2, 691.8, 691.6, 692, D6/692.4, 708, 708.16; 108/151, 153.1, 108/155, 156, 157.1, 158.12, 161; 248/188, 248/188.1

See application file for complete search history.

**References Cited**

**U.S. PATENT DOCUMENTS**

- D115,285 S \* 6/1939 Conkling, Jr. .... D6/455
- D156,437 S 12/1949 Kuehne, Jr.
- D214,672 S 7/1969 Ricca
- D386,331 S \* 11/1997 Grosfillex ..... D6/495

(57) **CLAIM**

The ornamental design for a table base, as shown and described.

**DESCRIPTION**

FIG. 1 is a first perspective view of a table base; FIG. 2 is a second perspective view thereof; FIG. 3 is a side view thereof, the opposing side being identical; FIG. 4 is a front view thereof, the rear being identical; FIG. 5 is a top view thereof; and, FIG. 6 is a bottom view thereof.

The uniform broken lines shown in the drawings are included for purposes of illustrating portions of the table base that form no part of the claimed design; whereas, the non-uniform broken lines shown in the drawings are included for purposes of illustrating environment and form no part of the claimed design.

**1 Claim, 4 Drawing Sheets**

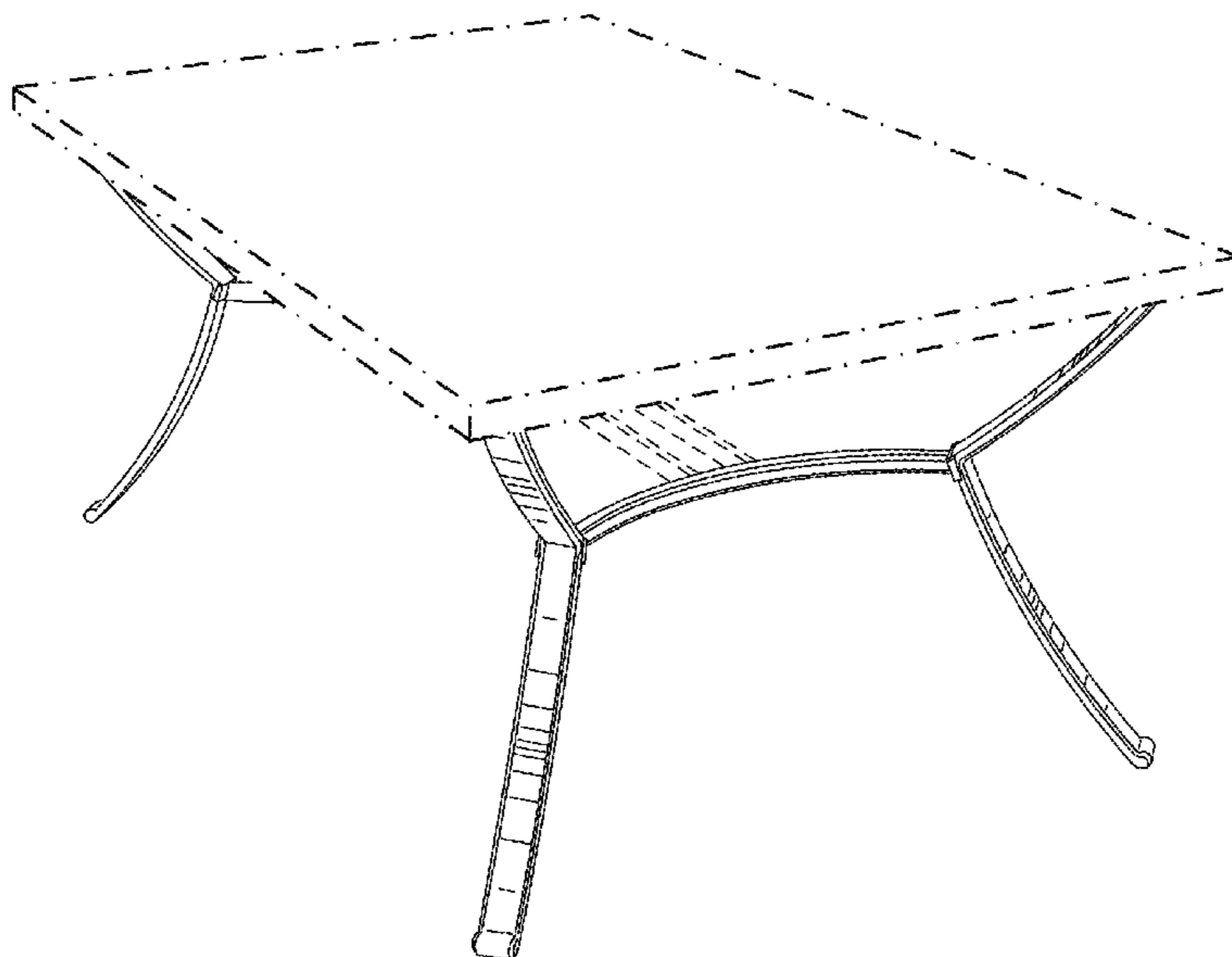

(56)

**References Cited**

OTHER PUBLICATIONS

The Home Depot, “Hampton Bay Andrews 7-Piece Patio Dining Set,” 1 page, [http://www.homedepot.com/Outdoors-Patio-Furniture-Dining-Sets/h\\_d1/N-25ecodZ5yc1vZbxdr/R-202929219/h\\_d2/ProductDisplay?catalogId=10053&langId=-1&storeId=10051#UD5odaCwUaU](http://www.homedepot.com/Outdoors-Patio-Furniture-Dining-Sets/h_d1/N-25ecodZ5yc1vZbxdr/R-202929219/h_d2/ProductDisplay?catalogId=10053&langId=-1&storeId=10051#UD5odaCwUaU), at least as early as Aug. 2012.

Just Fine Tables, “Indoor—Outdoor Coffee Table on Heavy Decorative Metal Base,” 1 page, [http://justfintables.com/?attachment\\_id=1415](http://justfintables.com/?attachment_id=1415), at least as early as Aug. 2012.

Find n Save, “Waverly Patio Furniture,” 1 page, <http://findnsave.rstar.com/Products/>

ShopKo?catname=Patio+Furniture+%26+Accessories, at least as early as Aug. 2012.

\* cited by examiner

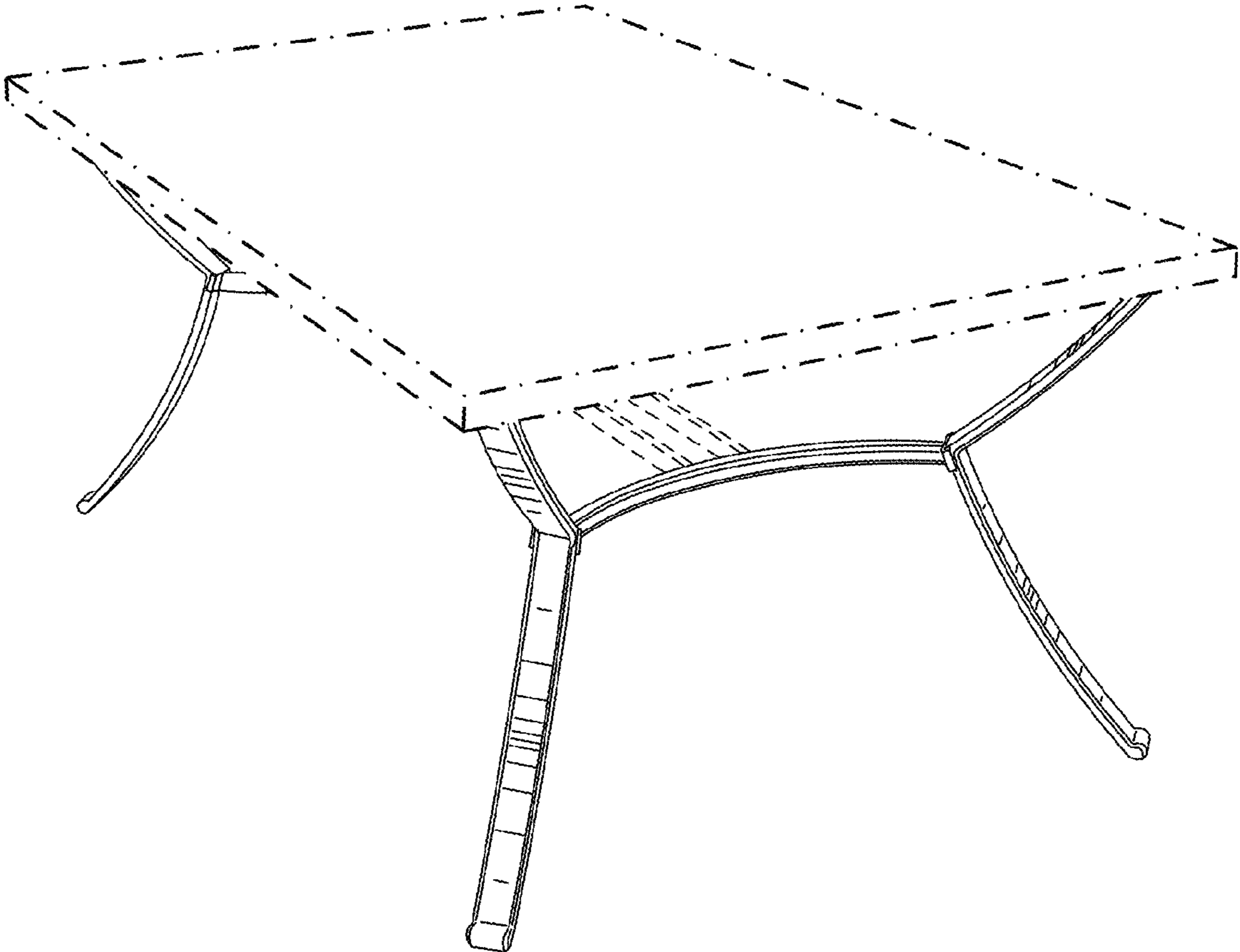

FIG. 1

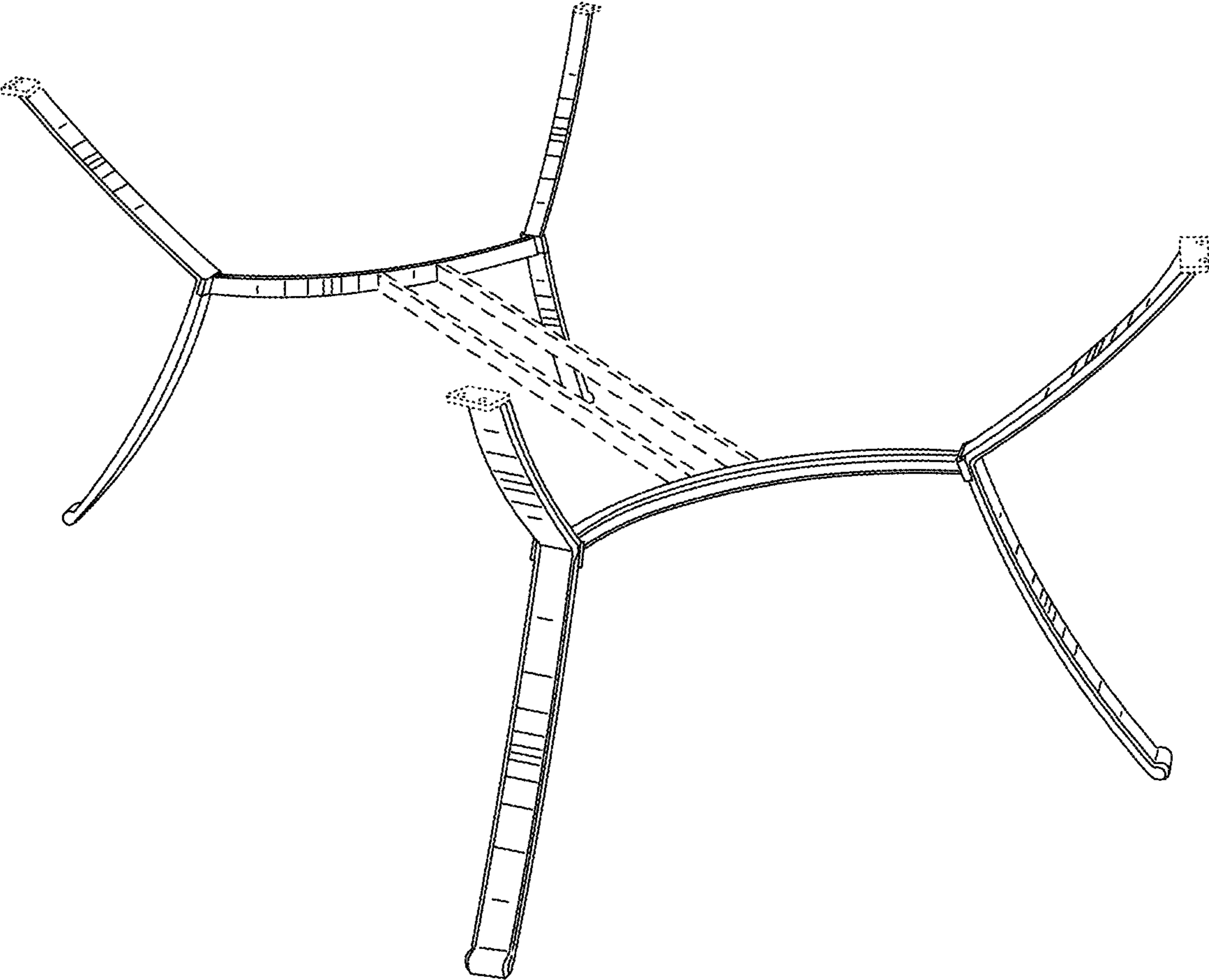

FIG. 2

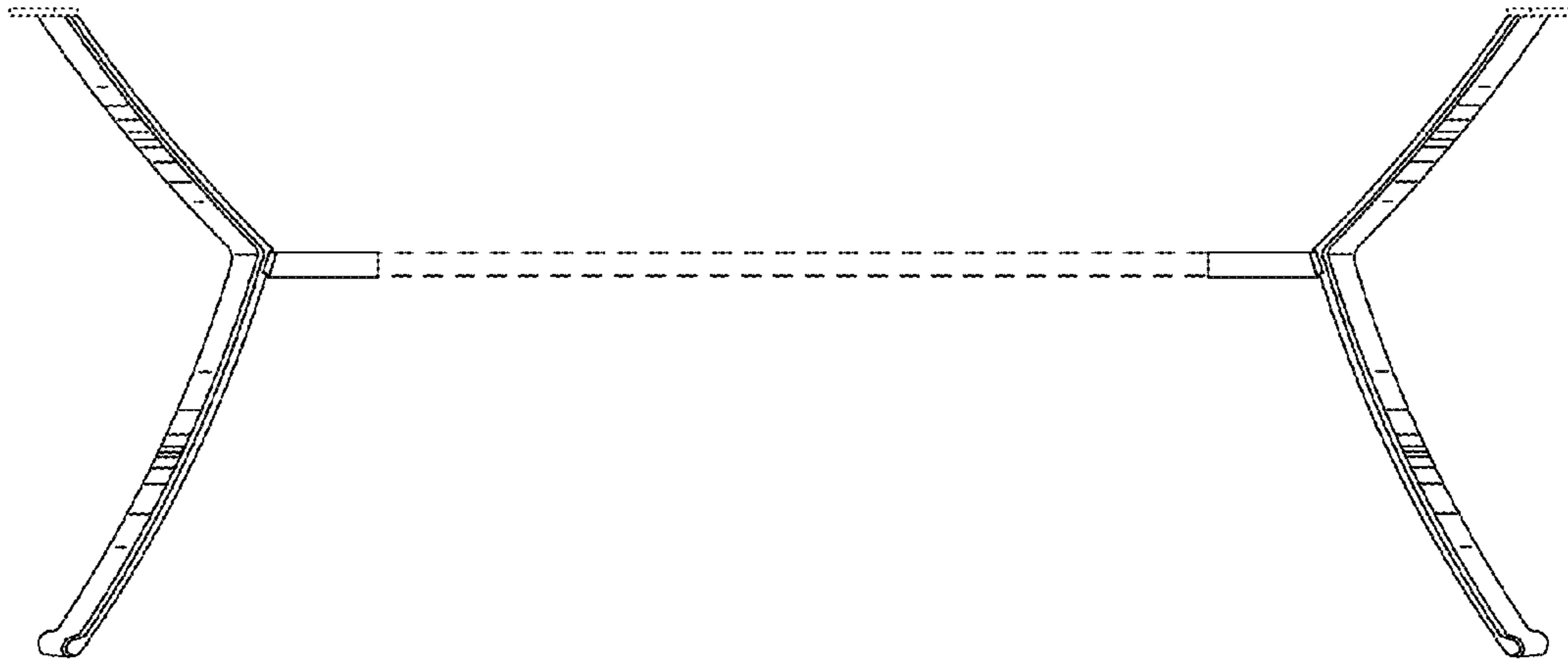

FIG. 3

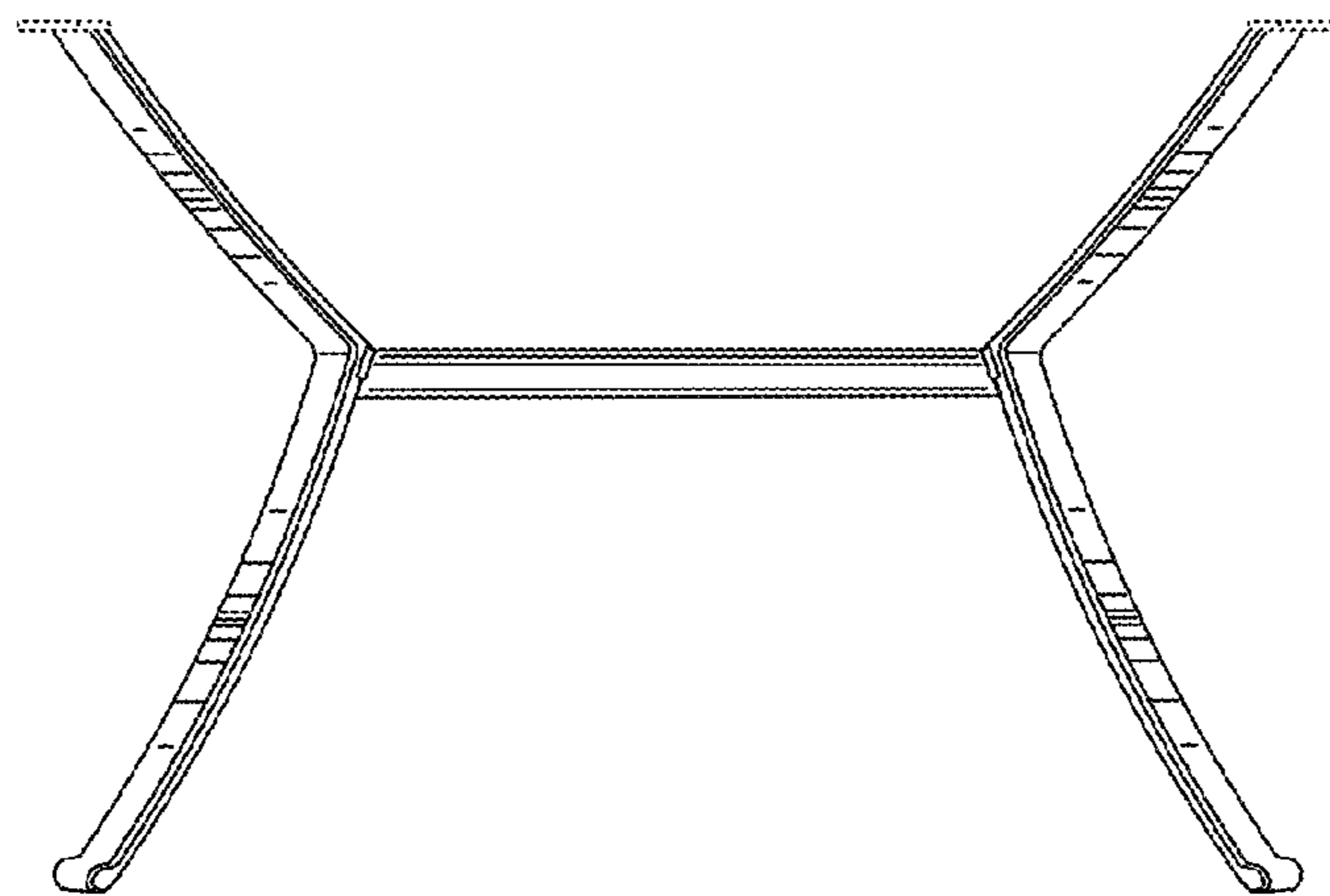

FIG. 4

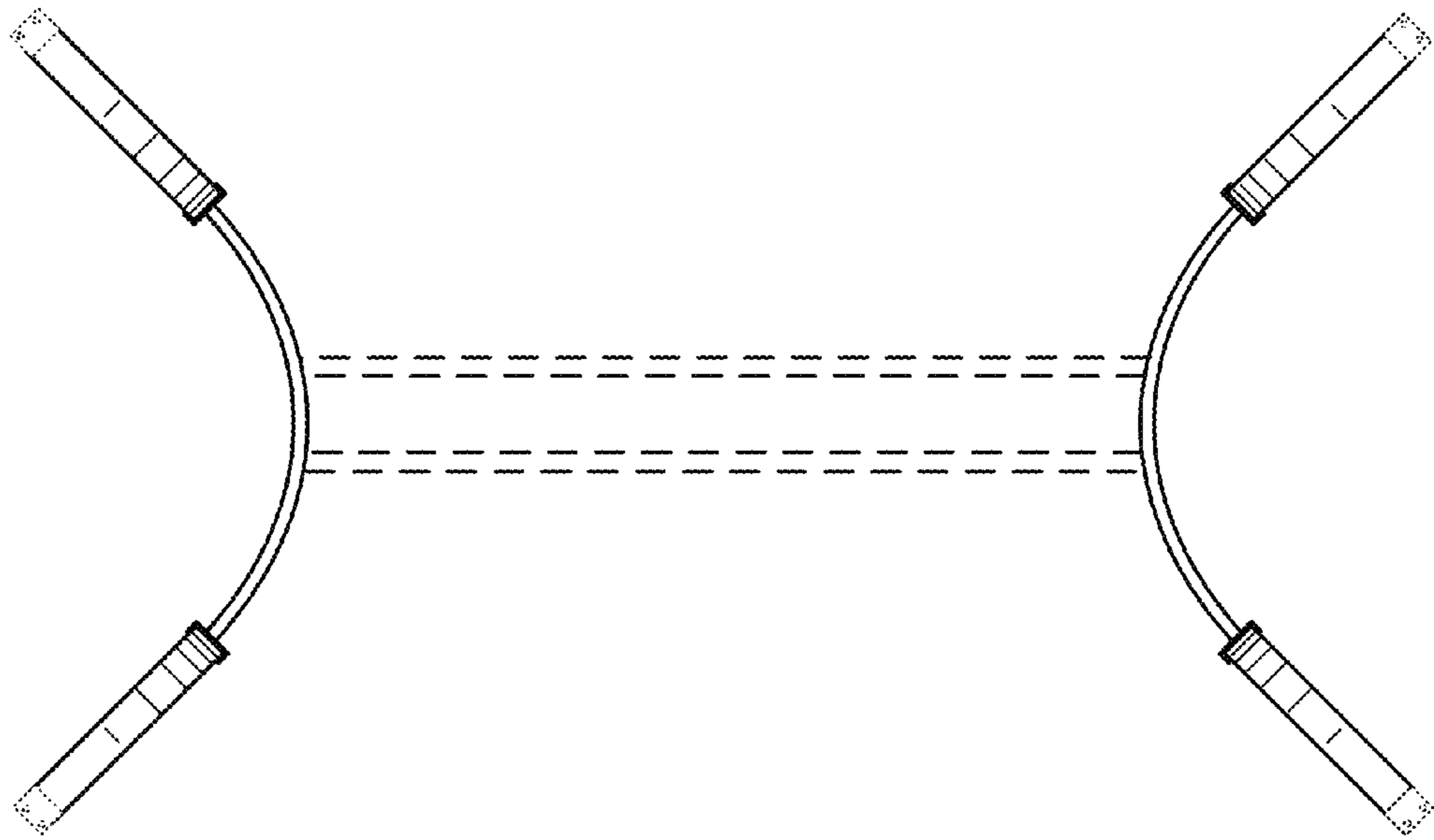

FIG. 5

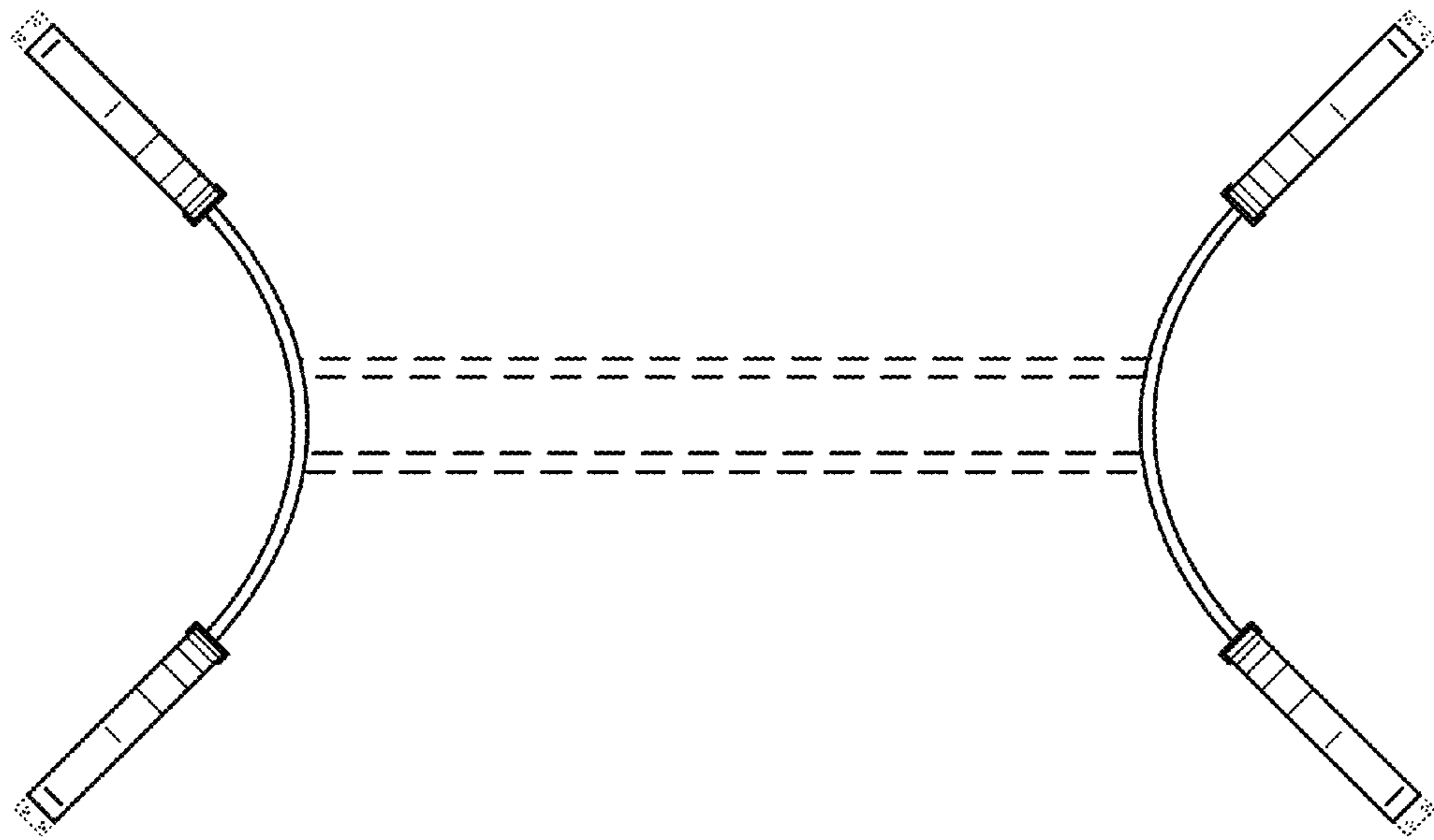

FIG. 6