



US00D716500S

(12) **United States Design Patent**
Parker

(10) **Patent No.:** **US D716,500 S**

(45) **Date of Patent:** **** Oct. 28, 2014**

(54) **COSMETIC COMPACT CASE**

(56) **References Cited**

(71) Applicant: **Phillipe Olivier Parker**, Zejtun (MT)

U.S. PATENT DOCUMENTS

(72) Inventor: **Phillipe Olivier Parker**, Zejtun (MT)

D401,017	S	*	11/1998	Thorpe	D28/78
D462,809	S	*	9/2002	LaSpina et al.	D28/78
D478,689	S	*	8/2003	Thorpe	D28/83
D479,016	S	*	8/2003	Sgariboldi	D28/78
D576,770	S	*	9/2008	Mascotte et al.	D28/83
2004/0200755	A1	*	10/2004	Gueret	206/581
2007/0029226	A1	*	2/2007	Yuhara et al.	206/581
2010/0008074	A1	*	1/2010	Kang	362/154

(**) Term: **14 Years**

* cited by examiner

(22) Filed: **Nov. 25, 2013**

Primary Examiner — Jennifer Rivard

(51) **LOC (10) Cl.** **28-03**

(57) **CLAIM**

(52) **U.S. Cl.**

I, claim the ornamental design for a cosmetic compact case, as shown and described.

USPC **D28/83**

DESCRIPTION

(58) **Field of Classification Search**

CPC A45D 33/006; A45D 33/003; A45D 33/04-33/16; A45D 33/025; A45D 33/02; A45D 33/20; A45D 33/22; A45D 33/24; A45D 33/26; A45D 33/28; A45D 33/18; A45D 40/22; A45D 40/222; A45D 40/24; A45D 42/02

FIG. 1 is a top view of a cosmetic compact case showing my new design

FIG. 2 is a bottom view thereof;

FIG. 3 is a front view thereof;

FIG. 4 is a rear view thereof;

FIG. 5 is a right side elevation view thereof;

FIG. 6 is a left side elevation view thereof; and,

FIG. 7 is a perspective view thereof.

USPC D28/64.1-64.7, 76-84; 206/581, 823; 132/286-318; D9/503-505

See application file for complete search history.

1 Claim, 1 Drawing Sheet

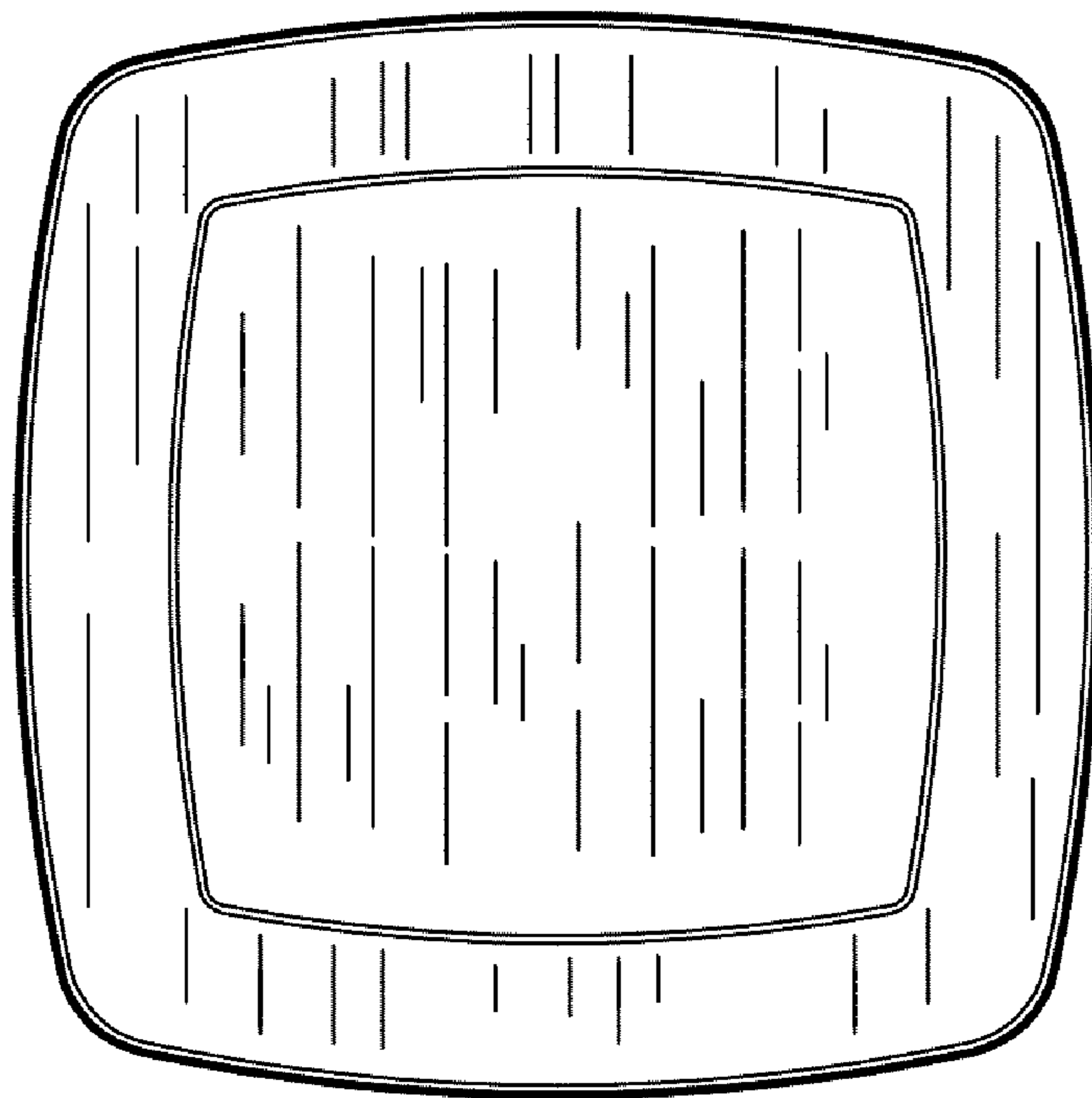

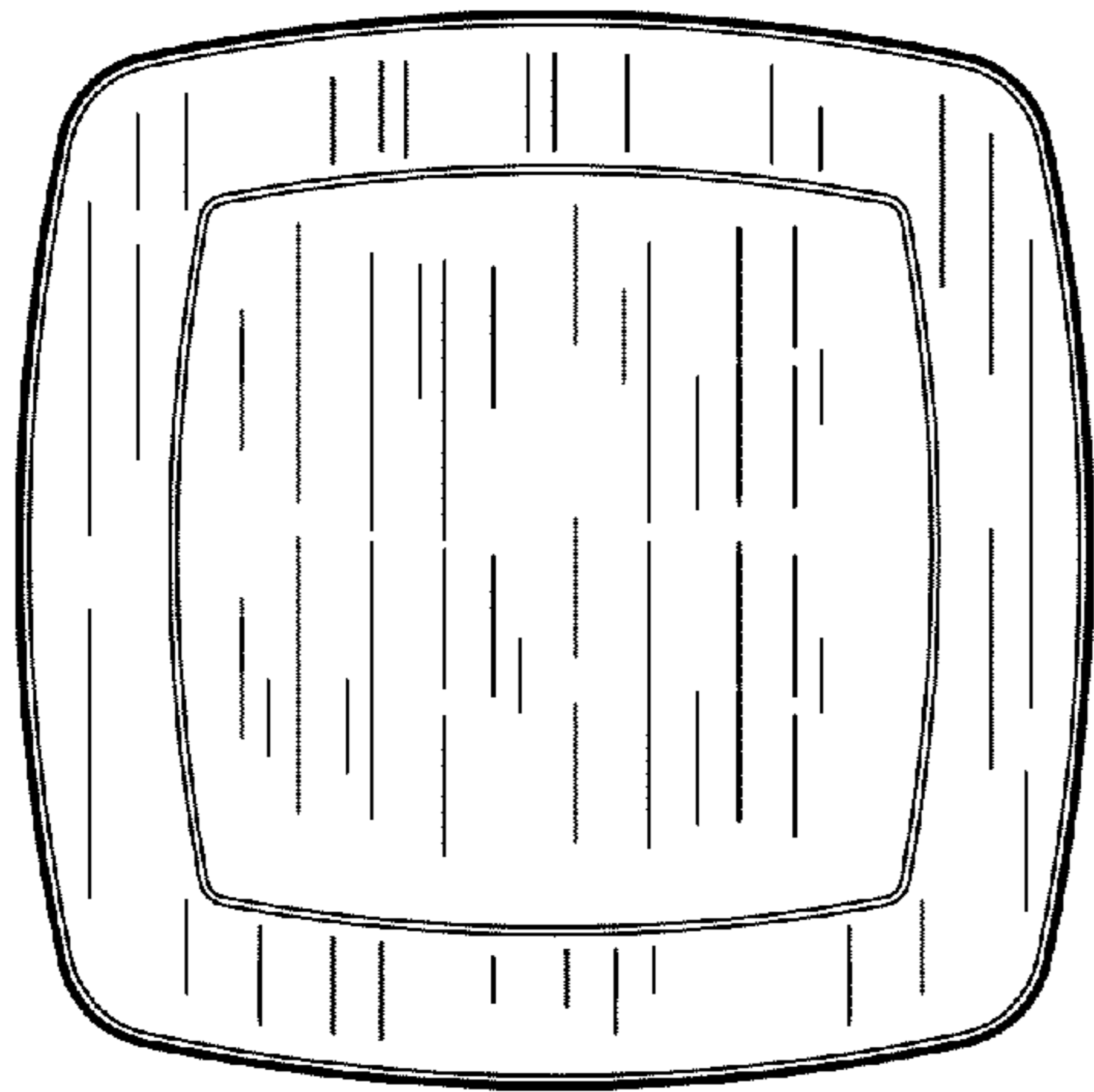

FIG.1

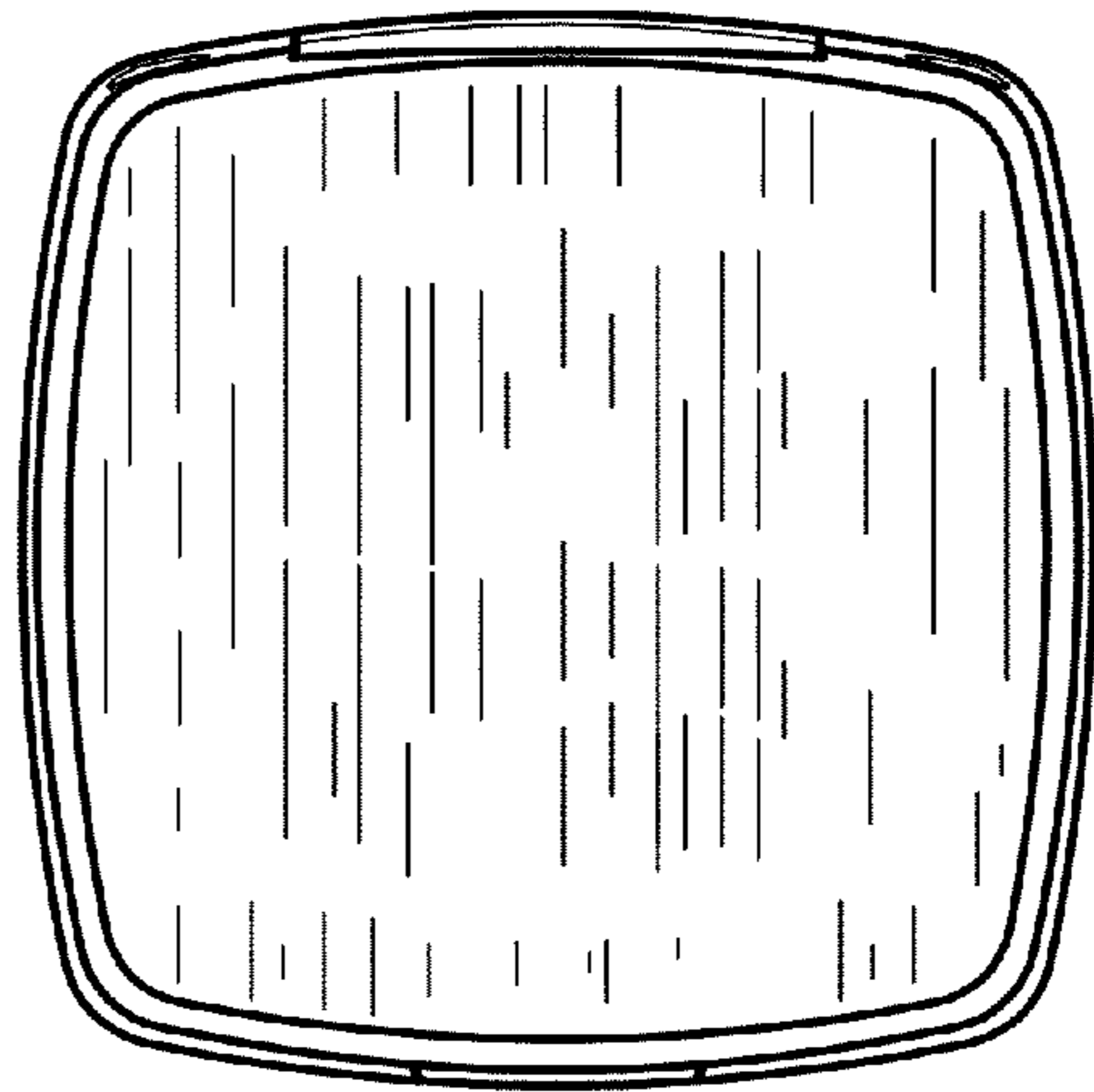

FIG.2



FIG.3

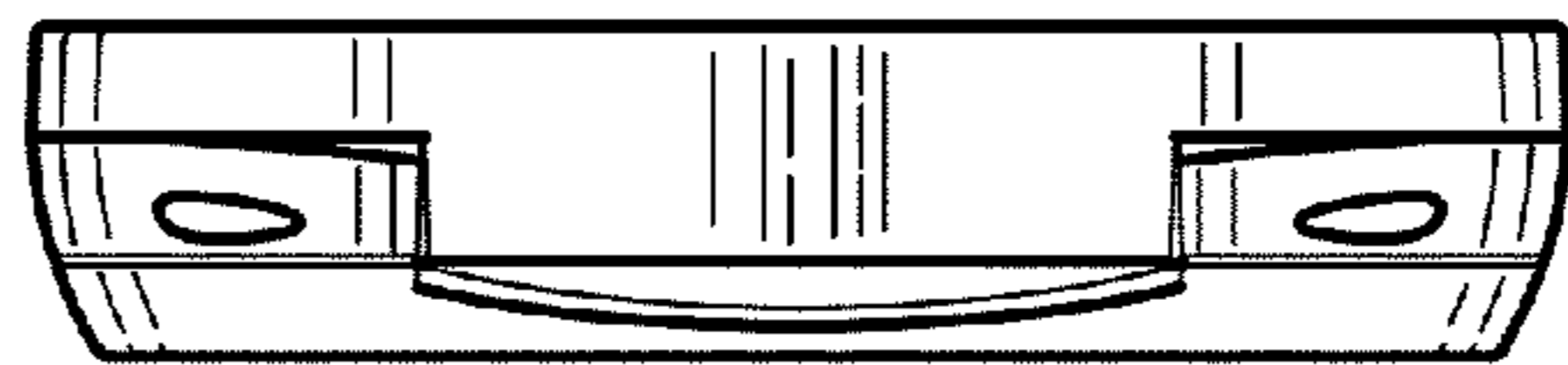

FIG.4

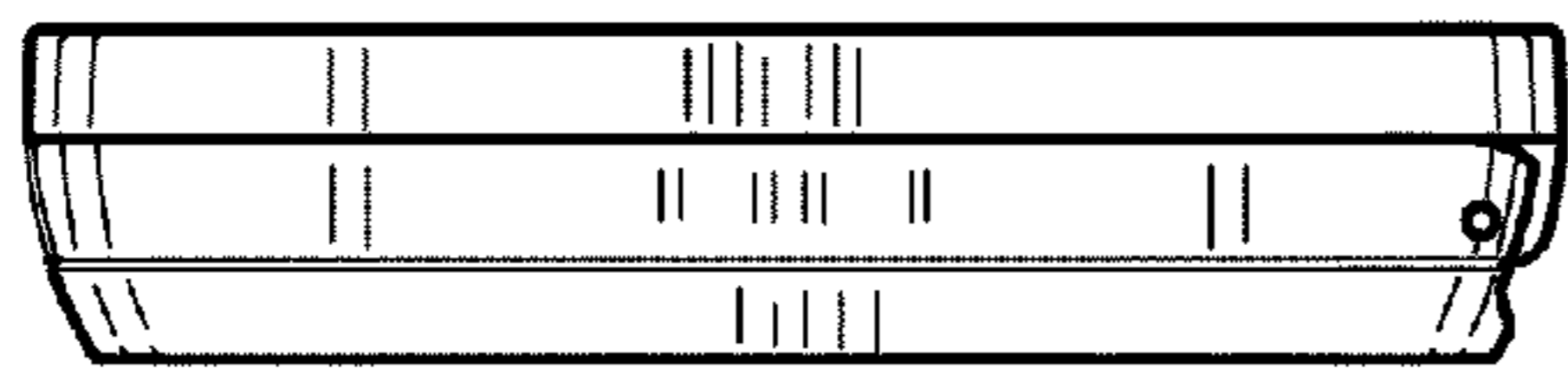

FIG.5

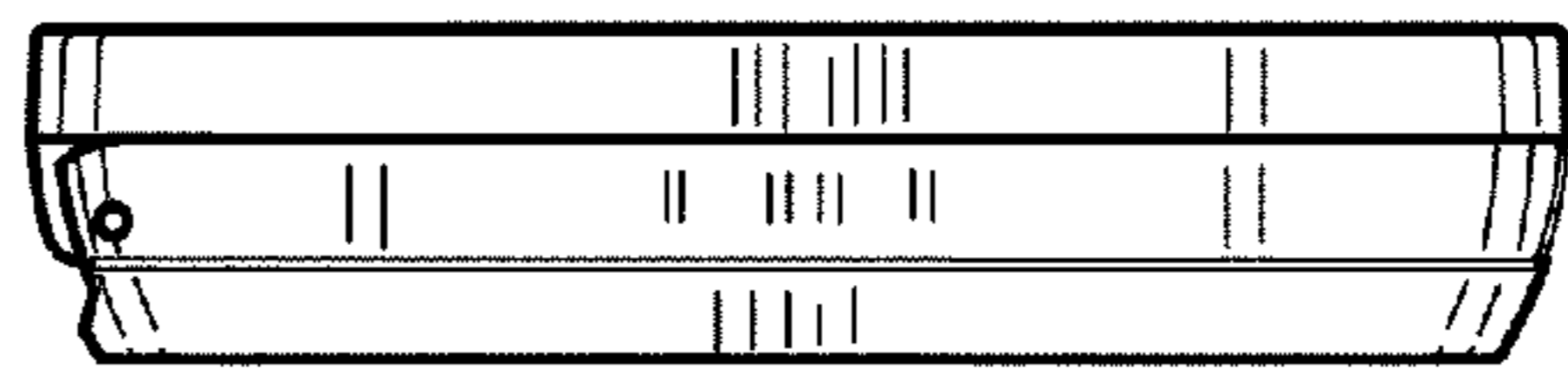

FIG.6

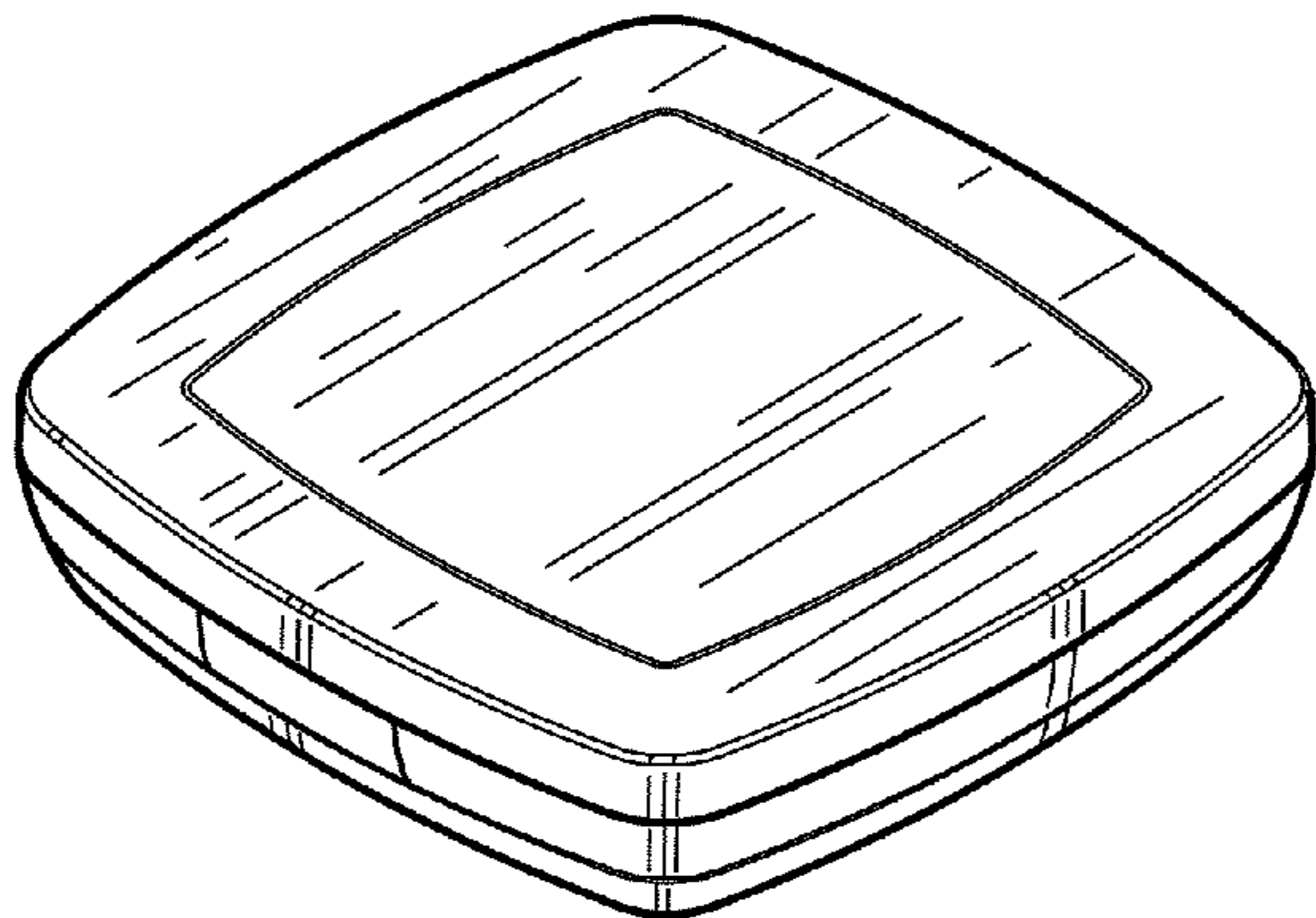

FIG.7