



US00D716474S

(12) **United States Design Patent**  
**Wysock et al.**

(10) **Patent No.:** **US D716,474 S**  
(45) **Date of Patent:** **\*\* Oct. 28, 2014**

(54) **DOOR FACING**

(71) Applicant: **Masonite Corporation**, Tampa, FL (US)

(72) Inventors: **Gregory J. Wysock**, Sycamore, IL (US);  
**Timothy D. Gouge**, Elgin, IL (US)

(73) Assignee: **Masonite Corporation**, Tampa, FL (US)

(\*\*) Term: **14 Years**

(21) Appl. No.: **29/471,385**

(22) Filed: **Oct. 31, 2013**

(51) **LOC (10) Cl.** ..... **25-02**

(52) **U.S. Cl.**  
USPC ..... **D25/48.3**

(58) **Field of Classification Search**  
USPC ..... D25/48.3; 52/455, 458, 784.13; 49/504  
See application file for complete search history.

(56) **References Cited**

U.S. PATENT DOCUMENTS

D530,431	S	*	10/2006	Walsh et al.	.....	D25/48.3
D607,579	S	*	1/2010	Walsh et al.	.....	D25/48.3
D616,109	S	*	5/2010	Steiber et al.	.....	D25/48.3
D617,005	S	*	6/2010	Mullet	.....	D25/48.3
2011/0036036	A1	*	2/2011	Thompson et al.	.....	52/455
2011/0107703	A1	*	5/2011	Mullet	.....	52/455

\* cited by examiner

*Primary Examiner* — Doris Clark

(74) *Attorney, Agent, or Firm* — Berenato & White, LLC

(57) **CLAIM**

The ornamental design for a door facing, as shown and described.

**DESCRIPTION**

FIG. 1 is a front perspective view of our design;  
 FIG. 2 is a front elevational view;  
 FIG. 3 is an enlarged fragmentary elevational view of a portion of FIG. 2;  
 FIG. 4 is a rear elevational view;  
 FIG. 5 is a top plan view;  
 FIG. 6 is a bottom plan view;  
 FIG. 7 is a cross sectional view taken along the line 7-7 of FIG. 2;  
 FIG. 8 is an enlarged fragmentary cross sectional view of a portion of FIG. 7;  
 FIG. 9 is a left side elevational view;  
 FIG. 10 is a right side elevational view;  
 FIG. 11 is a cross sectional view taken along the line 11-11 of FIG. 2;  
 FIG. 12 is an enlarged fragmentary cross sectional view of a portion of FIG. 11;  
 FIG. 13 is a front perspective view of a second embodiment of our design;  
 FIG. 14 is a front elevational view of FIG. 13;  
 FIG. 15 is an enlarged fragmentary elevational view of a portion of FIG. 14;  
 FIG. 16 is a rear elevational view of FIG. 13;  
 FIG. 17 is a top plan view of FIG. 14;  
 FIG. 18 is a bottom plan view of FIG. 14;  
 FIG. 19 is a cross sectional view taken along the line 19-19 of FIG. 14;  
 FIG. 20 is an enlarged fragmentary cross sectional view of a portion of FIG. 19;  
 FIG. 21 is a left side elevational view of FIG. 14;  
 FIG. 22 is a right side elevational view of FIG. 14;  
 FIG. 23 is a cross sectional view taken along the line 23-23 of FIG. 14; and,  
 FIG. 24 is an enlarged fragmentary cross sectional view of a portion of FIG. 23.

**1 Claim, 14 Drawing Sheets**

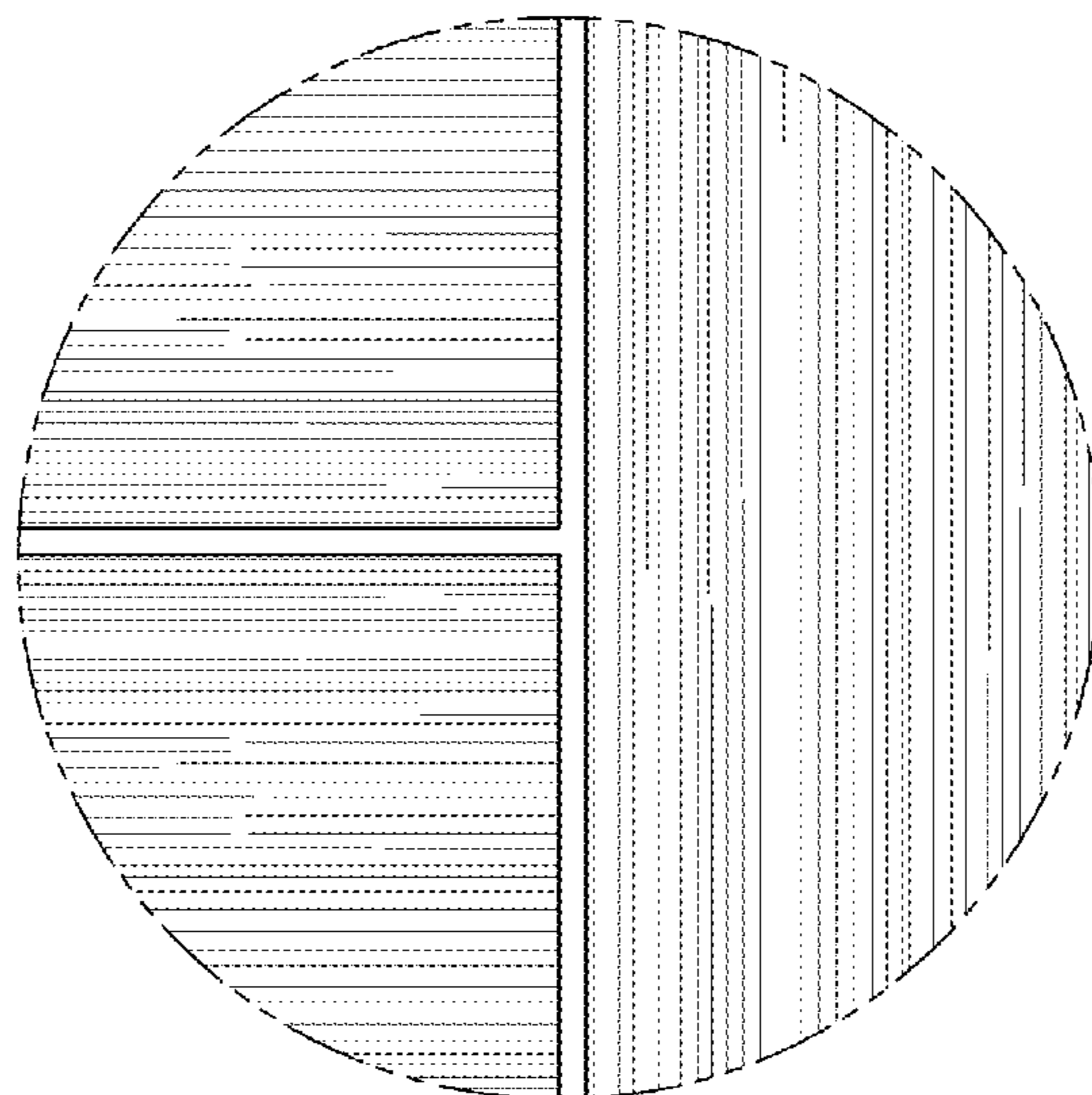

Fig. 1

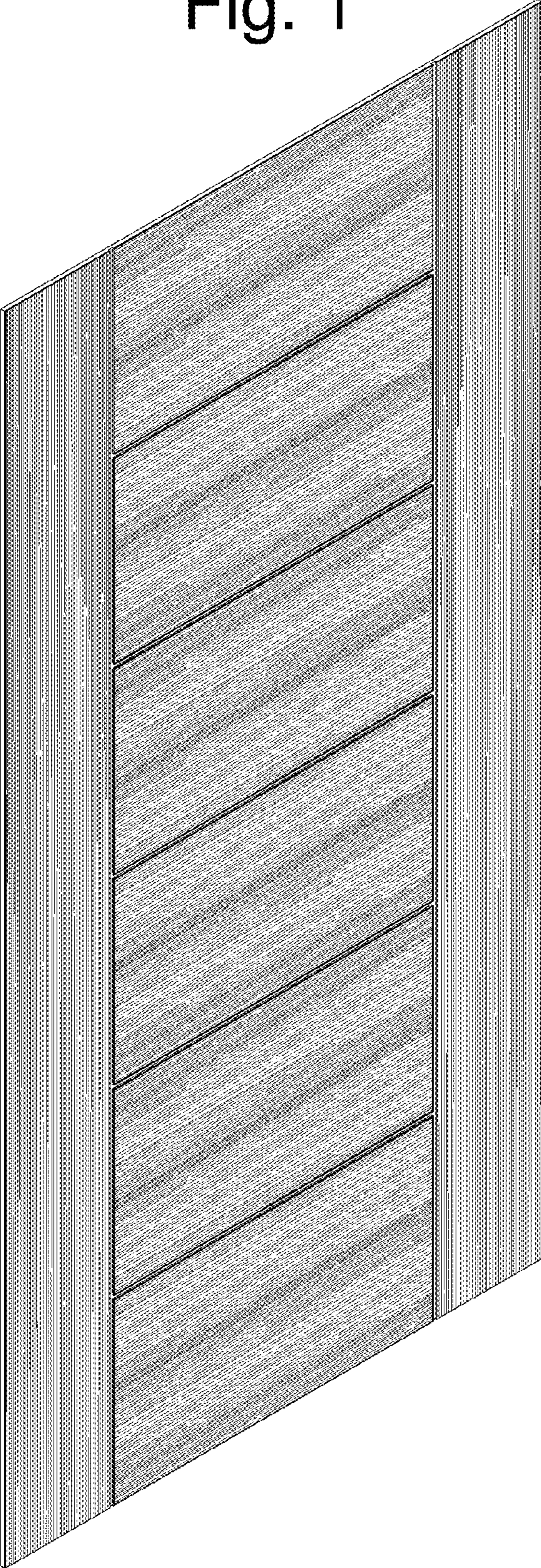

Fig. 2

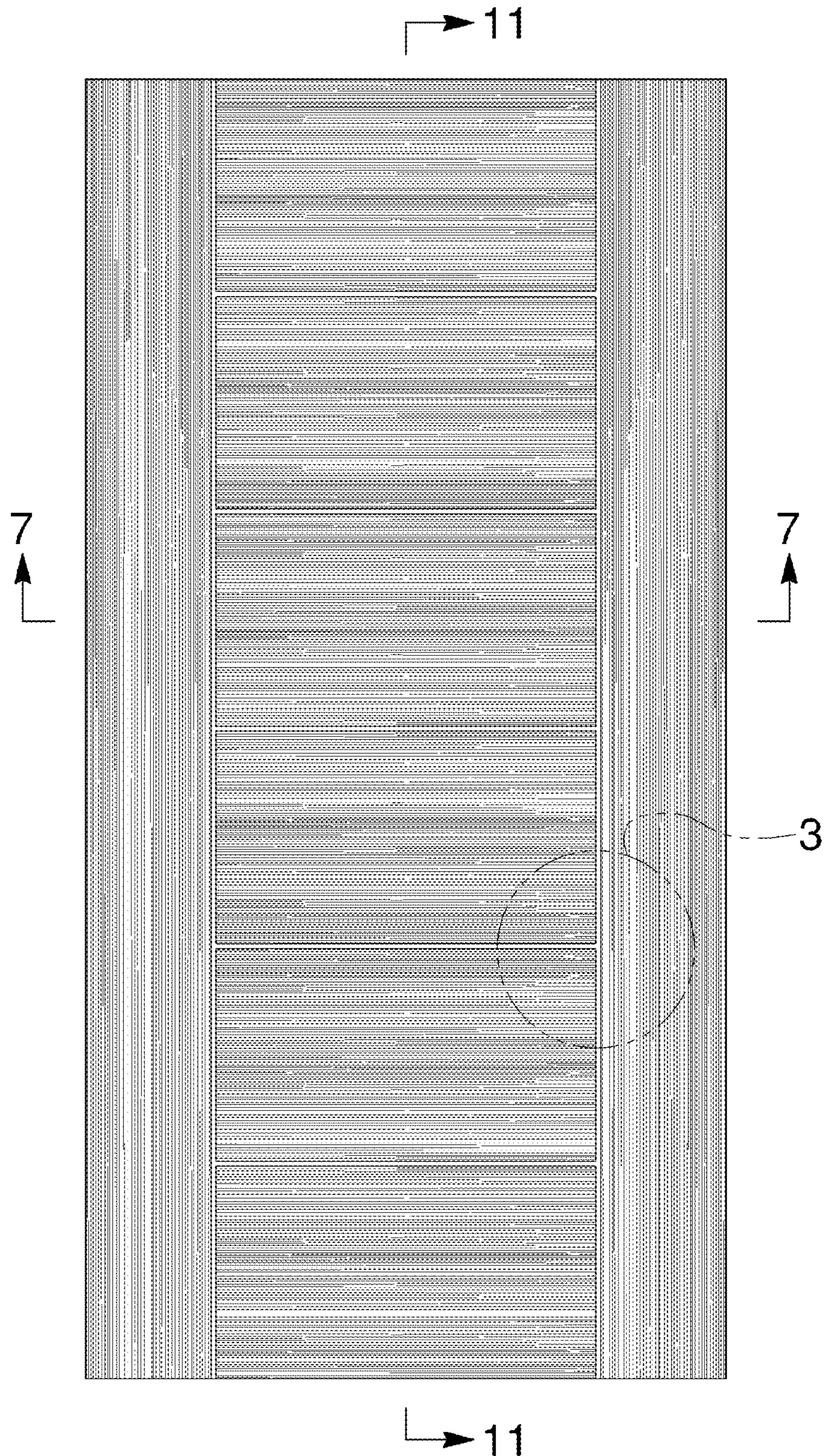

Fig. 3

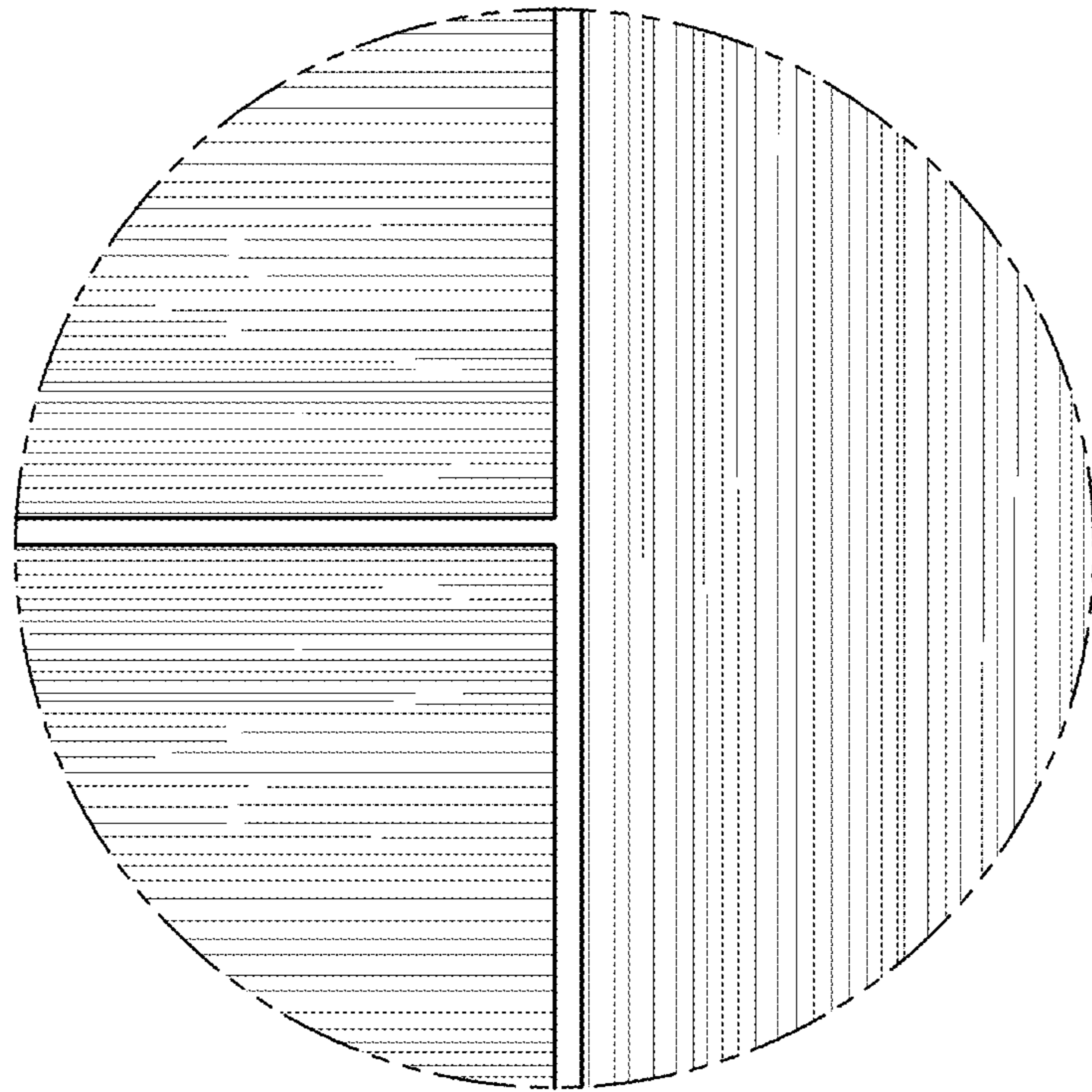

Fig. 4

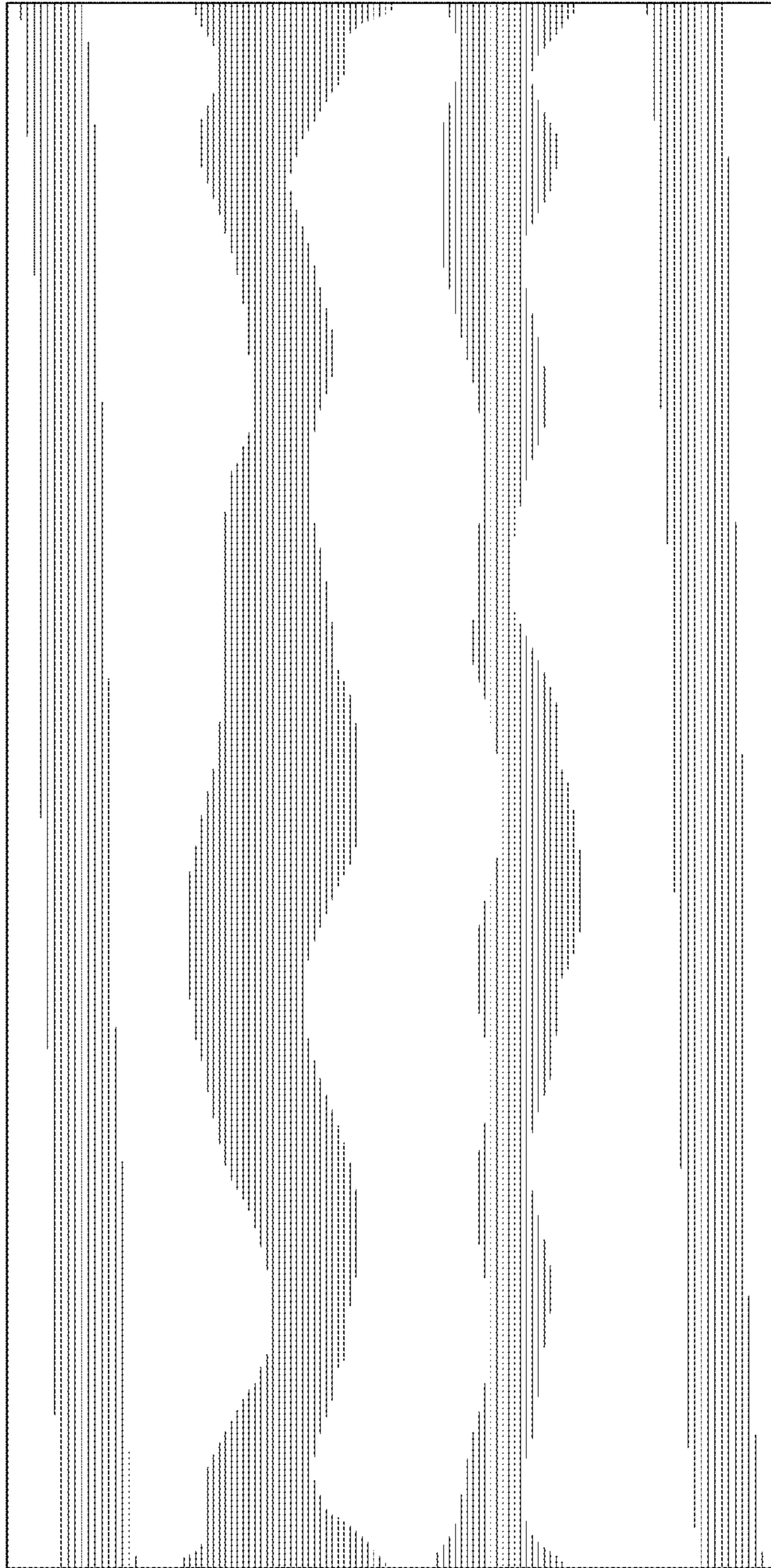

Fig. 5

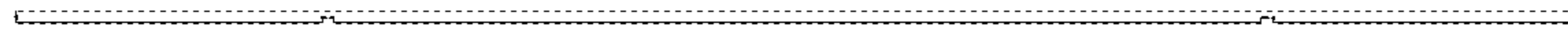

Fig. 6

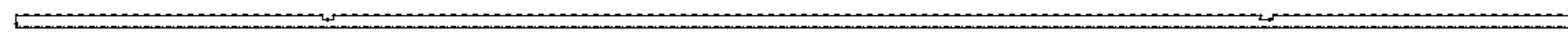

Fig. 7

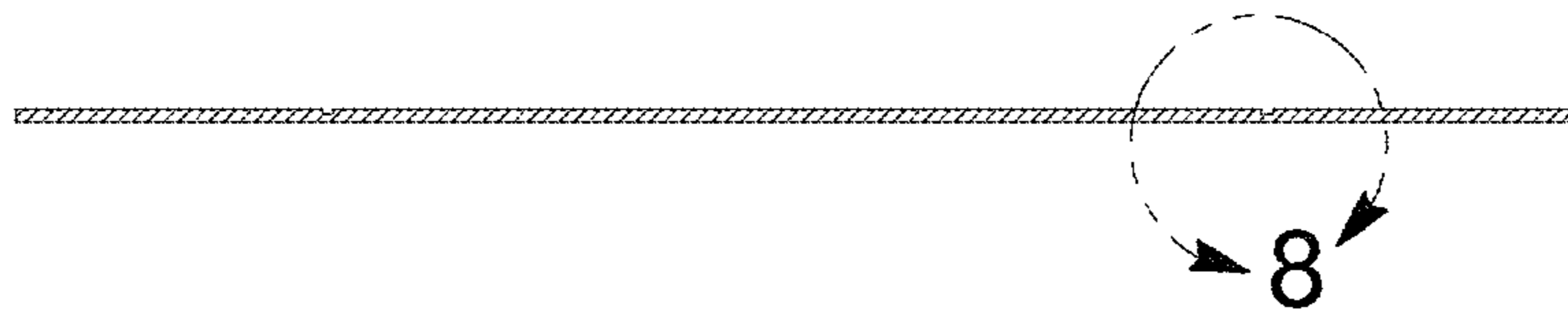

Fig. 8

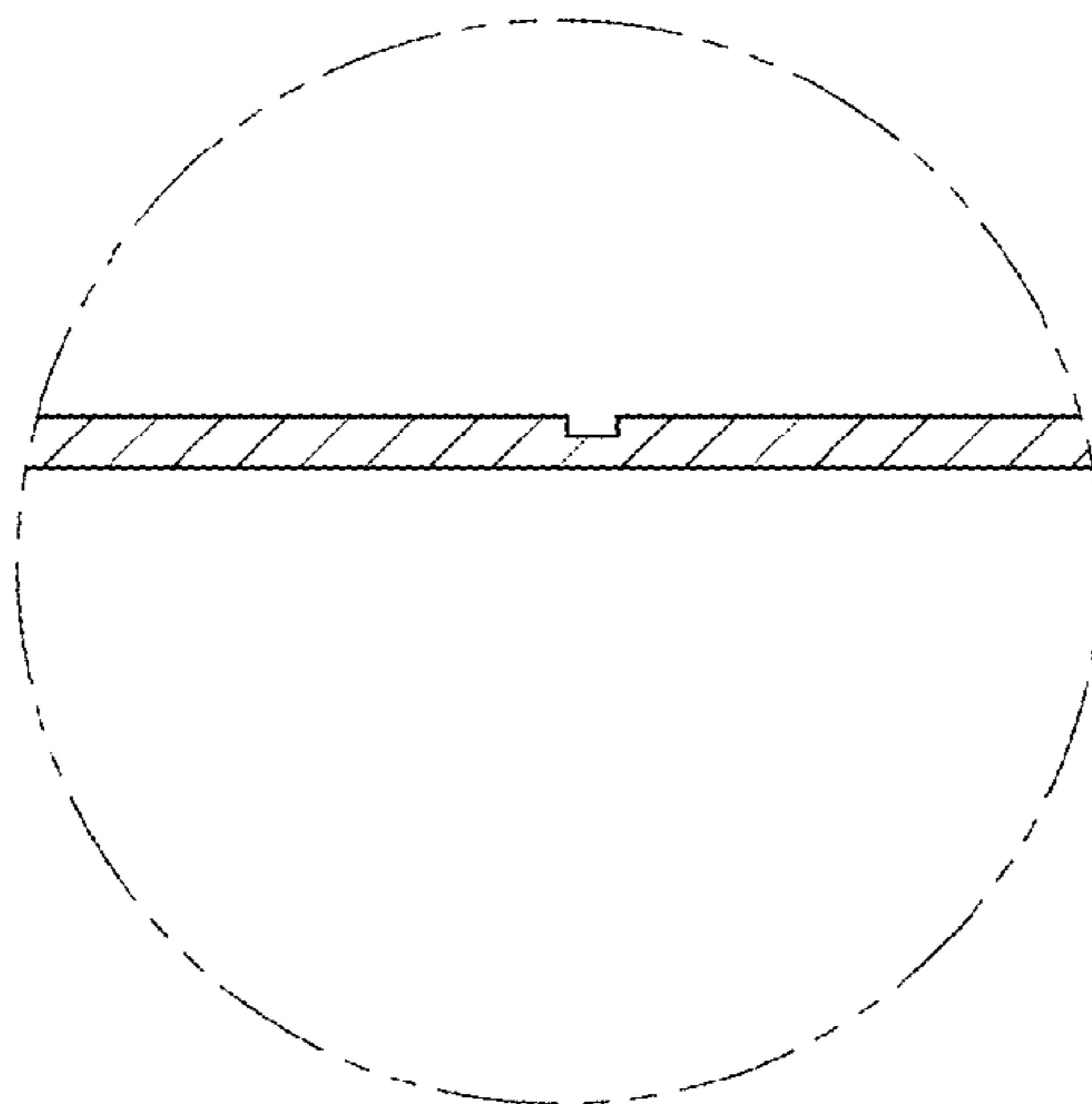

Fig. 9



Fig. 10

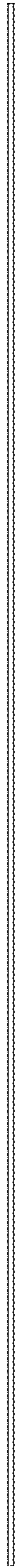

Fig. 11

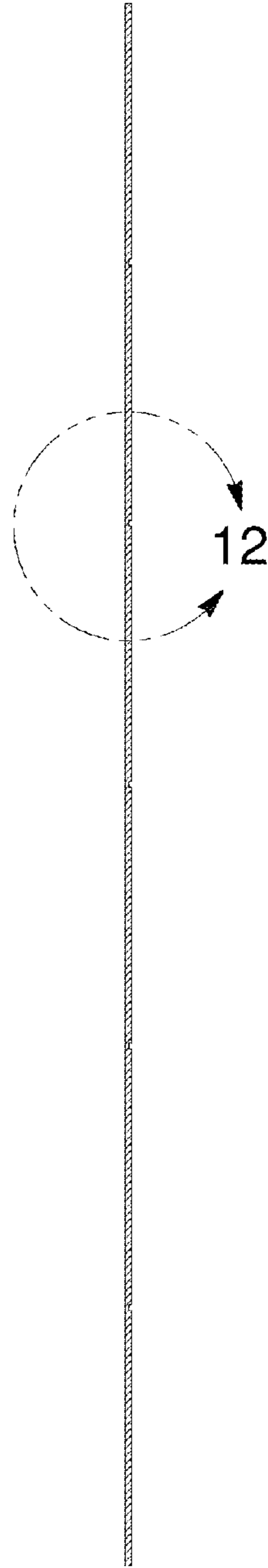

Fig. 12

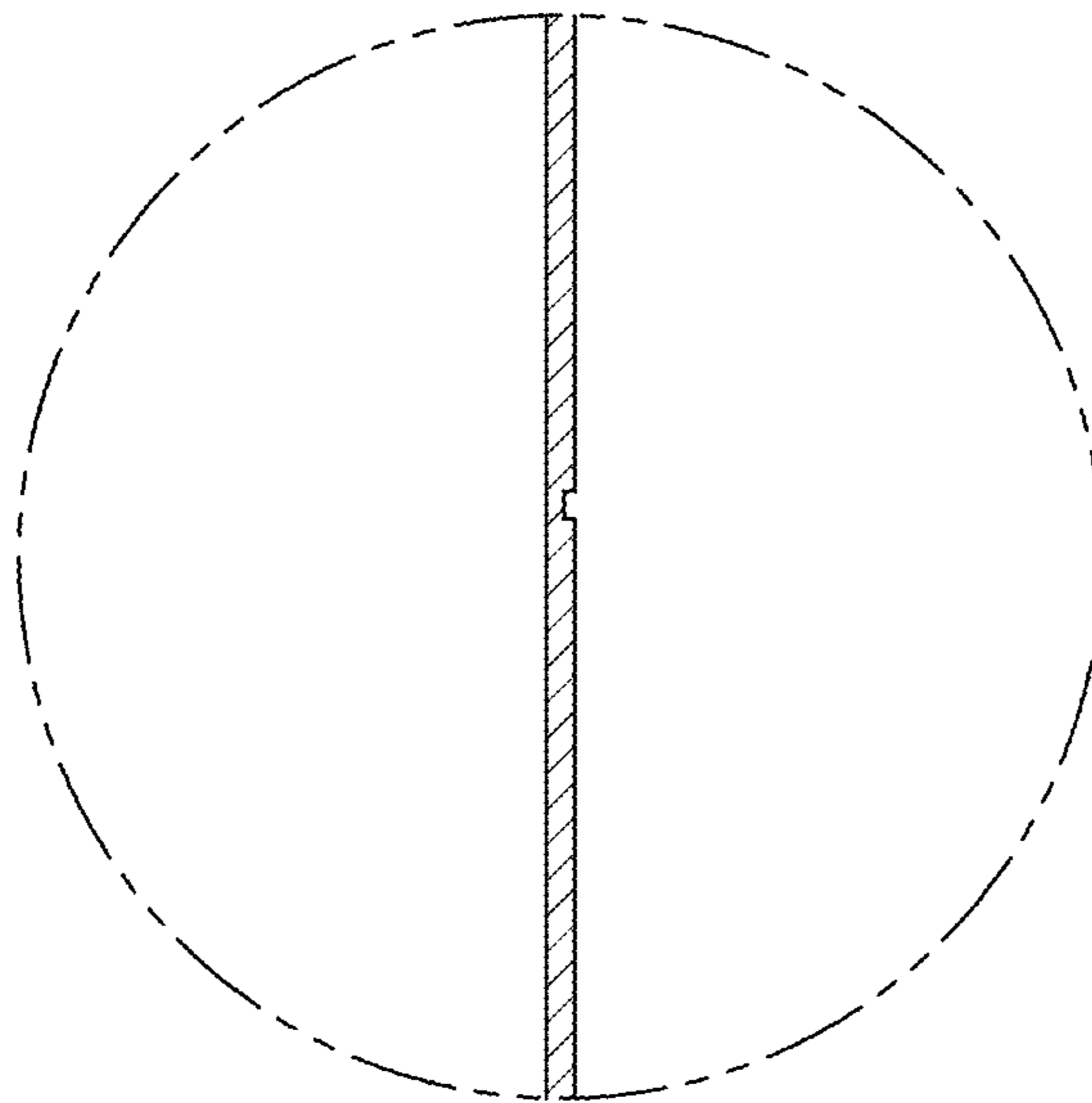



Fig. 13

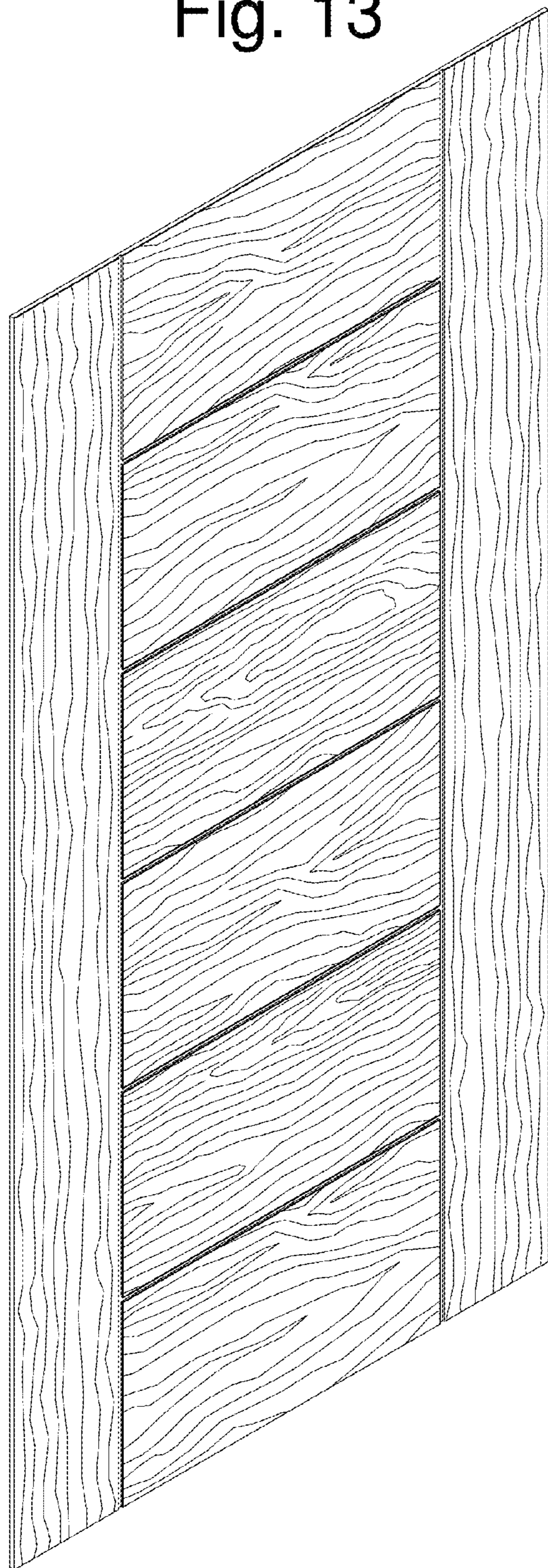

Fig. 14

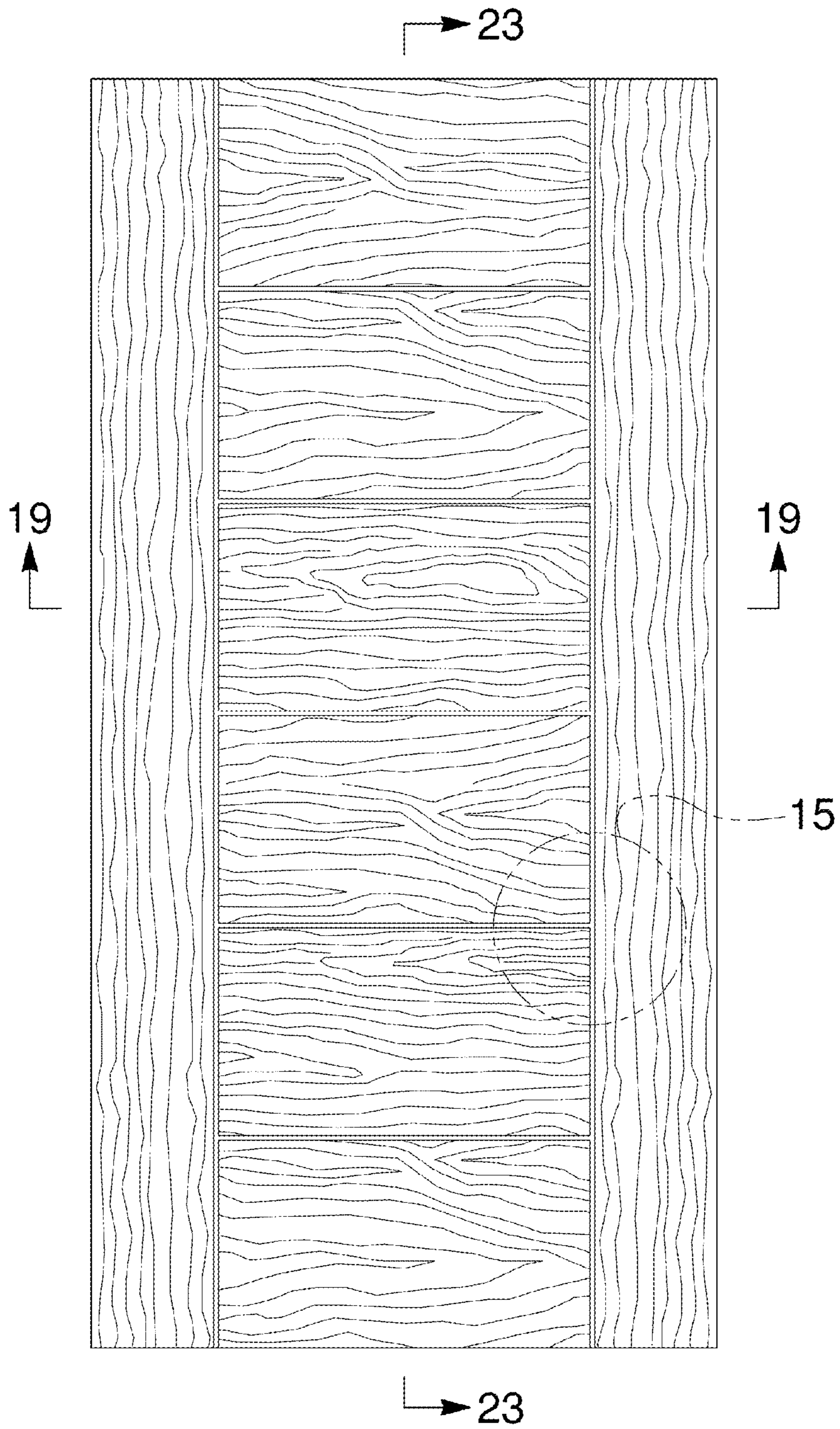

Fig. 15

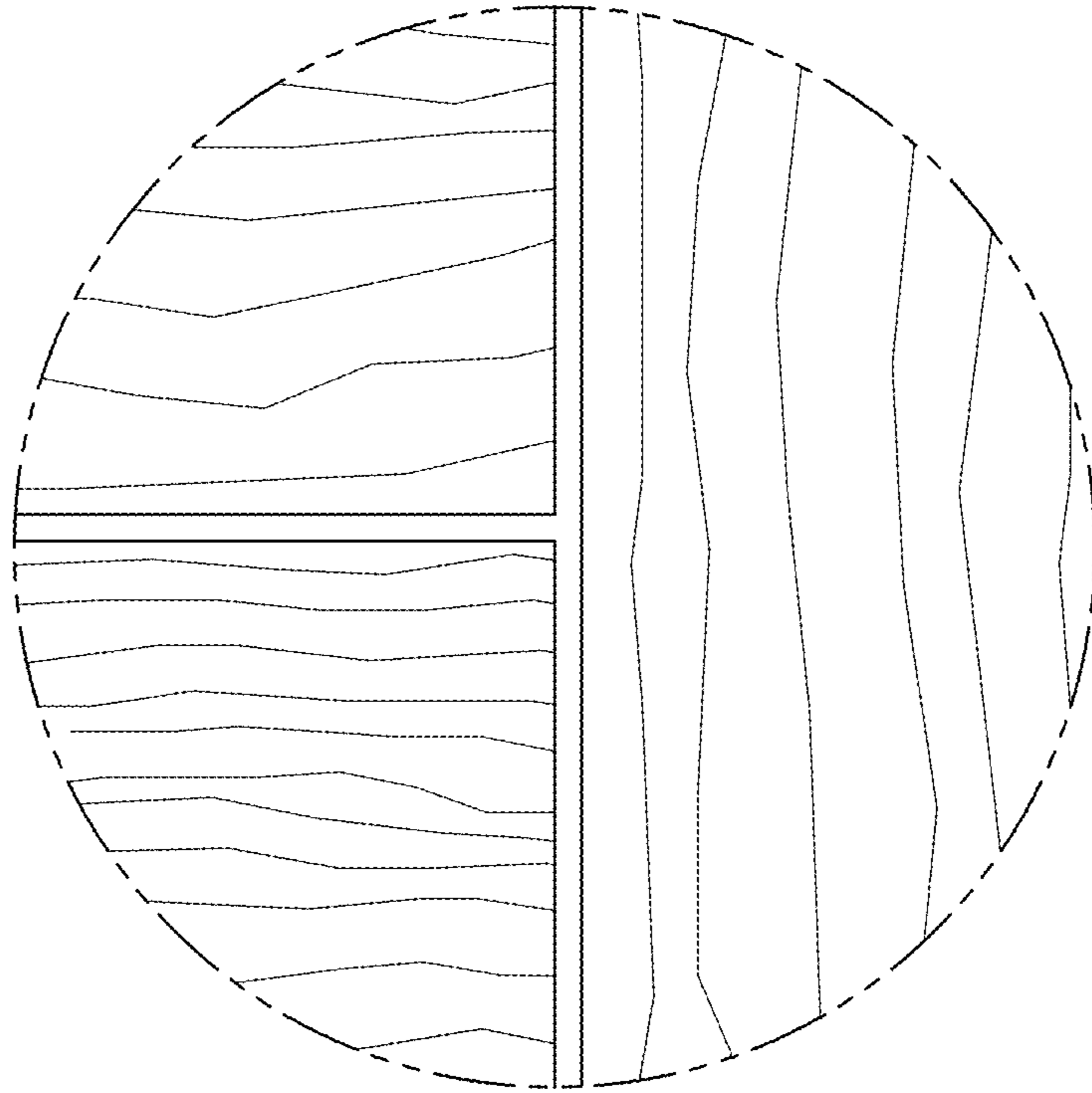

Fig. 16

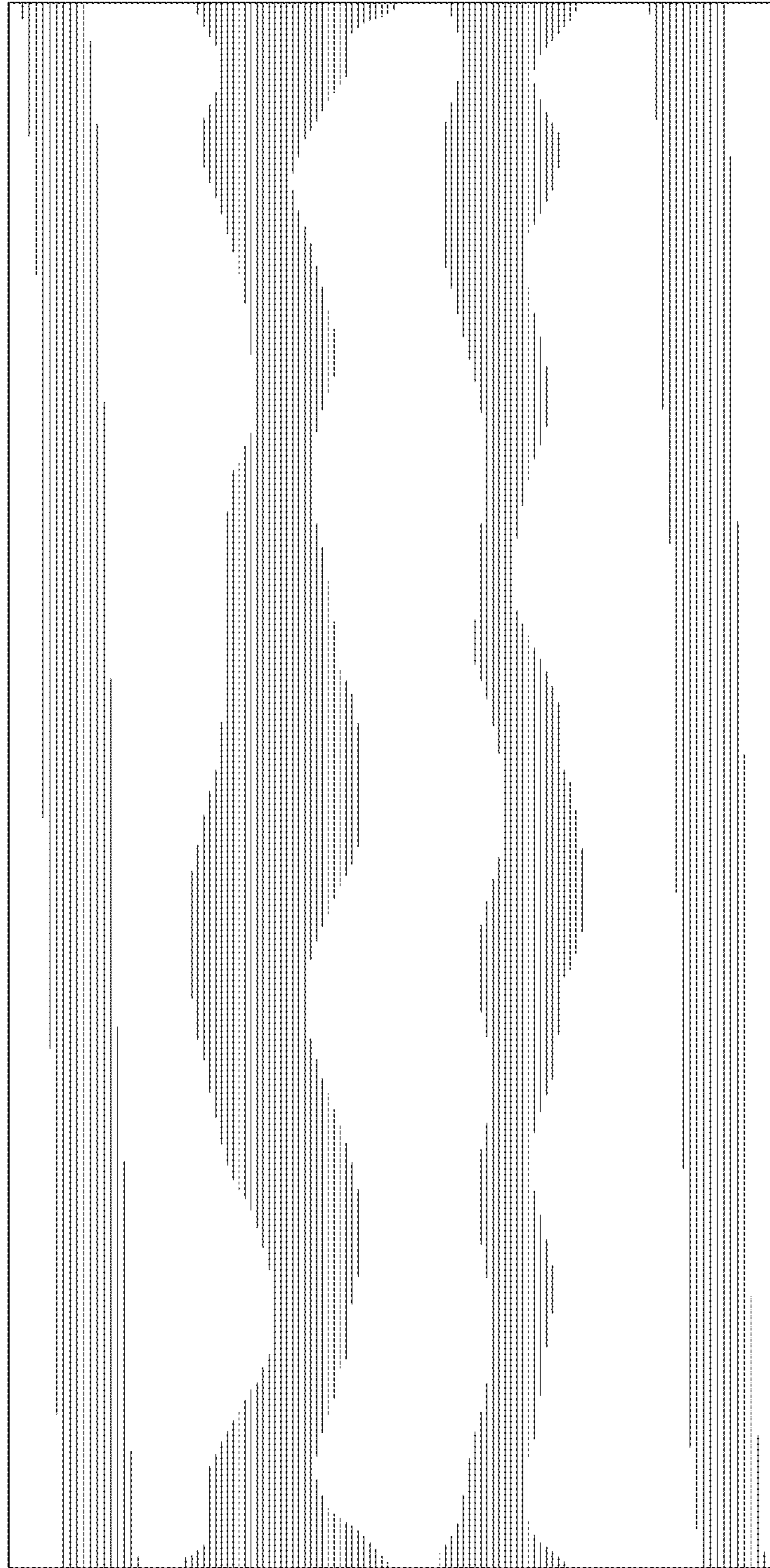

Fig. 17

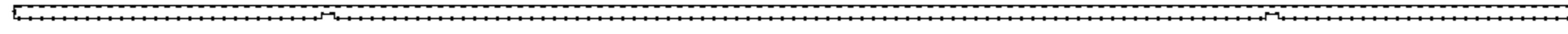

Fig. 18

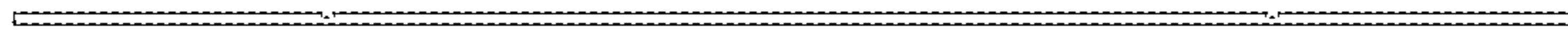

Fig. 19

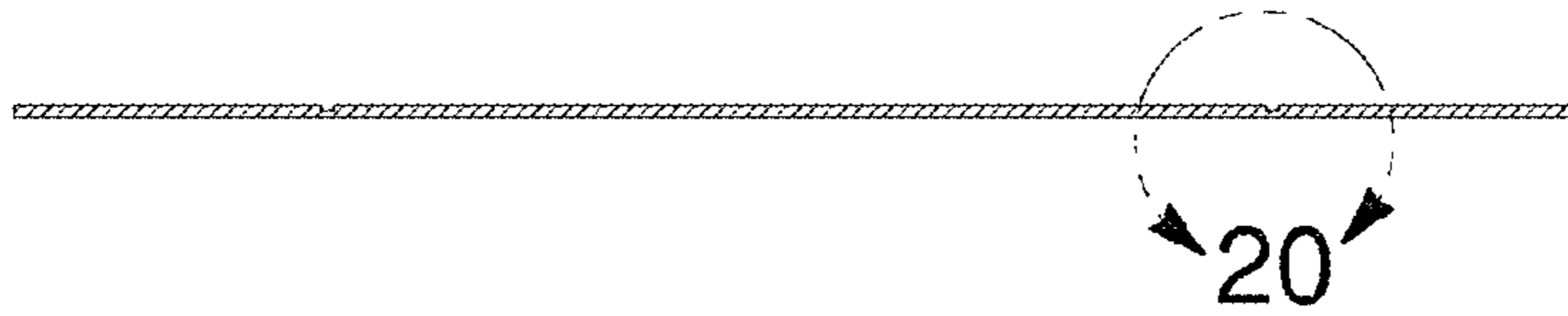

Fig. 20

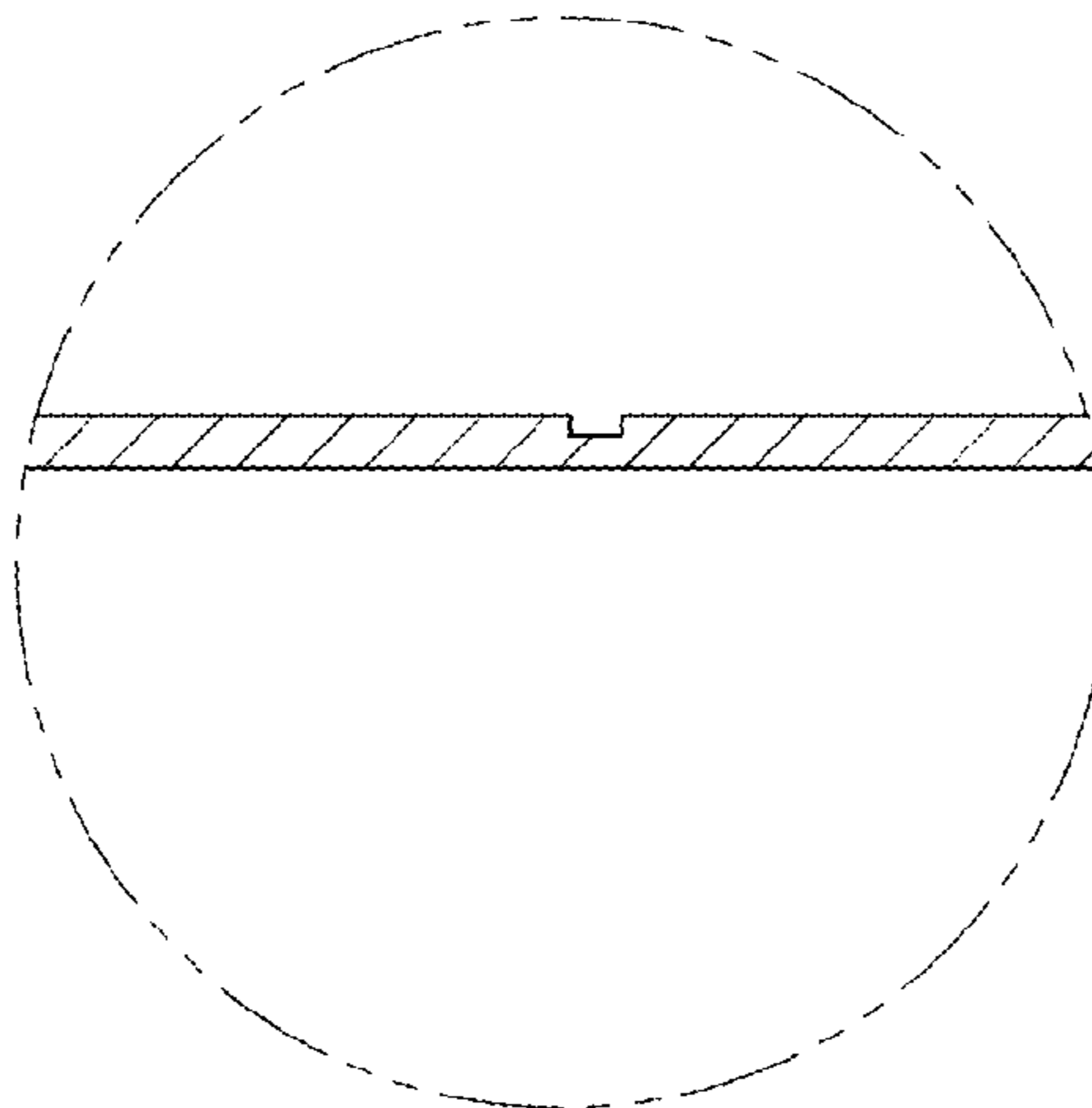

Fig. 21



Fig. 22

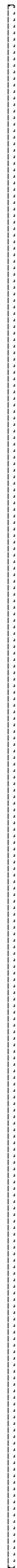

Fig. 23

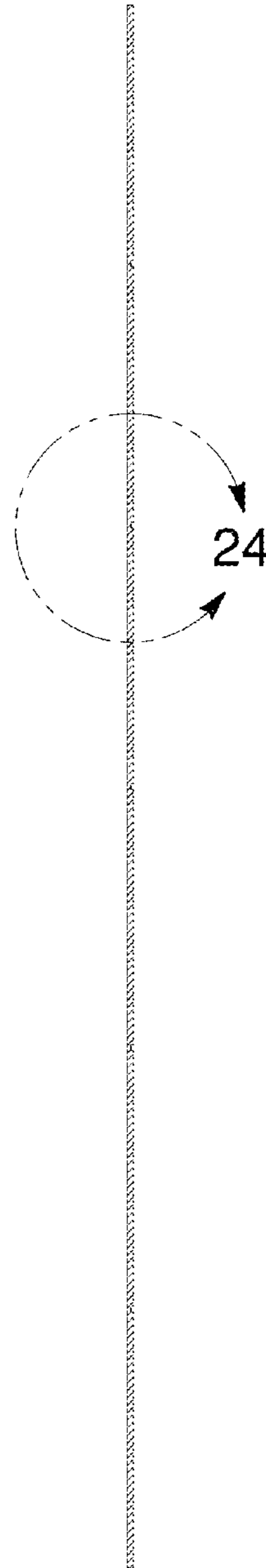

Fig. 24

