



US00D716389S

(12) **United States Design Patent**  
**Wieland et al.**

(10) **Patent No.:** **US D716,389 S**

(45) **Date of Patent:** **\*\* Oct. 28, 2014**

(54) **GOLF CLUB HEAD**

D508,722 S \* 8/2005 Iwata et al. .... D21/759  
D645,103 S \* 9/2011 Llewellyn et al. .... D21/759  
D682,961 S \* 5/2013 Llewellyn et al. .... D21/747

(71) Applicant: **Callaway Golf Company**, Carlsbad, CA (US)

\* cited by examiner

(72) Inventors: **Chris J. Wieland**, Vista, CA (US);  
**Matthew S. Hoffmeyer**, Carlsbad, CA (US); **Larry G. Tang**, Carlsbad, CA (US); **Scott R. Manwaring**, Carlsbad, CA (US); **Philip G. Foster**, Carlsbad, CA (US); **Sean P. Griffin**, Carlsbad, CA (US)

*Primary Examiner* — Mitchell Siegel

(74) *Attorney, Agent, or Firm* — Rebecca Hanovice; Michael A. Catania; Sonia Lari

(57) **CLAIM**

The ornamental design for a golf club head, as shown and described.

(73) Assignee: **Callaway Golf Company**, Carlsbad, CA (US)

**DESCRIPTION**

(\*\*) Term: **14 Years**

(21) Appl. No.: **29/472,377**

(22) Filed: **Nov. 12, 2013**

(51) **LOC (10) Cl.** ..... **21-02**

(52) **U.S. Cl.**  
USPC ..... **D21/759**

(58) **Field of Classification Search**  
USPC ..... D21/747–751, 759; 473/324–331, 350  
See application file for complete search history.

FIG. 1 is a rear perspective view of the golf club head;  
FIG. 2 is a front elevational view thereof;  
FIG. 3 is a rear elevational view thereof;  
FIG. 4 is a right side elevational view thereof;  
FIG. 5 is a left side elevational view thereof;  
FIG. 6 is a top plan view thereof;  
FIG. 7 is a bottom plan view thereof;  
FIG. 8 is a rear perspective view of a second embodiment of the golf club head as claimed herein;  
FIG. 9 is a front elevational view of FIG. 8;  
FIG. 10 is a rear elevational view of FIG. 8;  
FIG. 11 is a right side elevational view of FIG. 8;  
FIG. 12 is a left side elevational view of FIG. 8;  
FIG. 13 is a top plan view of FIG. 8; and,  
FIG. 14 is a bottom plan view of FIG. 8.  
The broken lines are included for the purpose of illustration only and form no part of the claimed design.

(56) **References Cited**

**U.S. PATENT DOCUMENTS**

D379,485 S \* 5/1997 Ragano ..... D21/749  
D466,961 S \* 12/2002 Nagai et al. .... D21/759

**1 Claim, 8 Drawing Sheets**

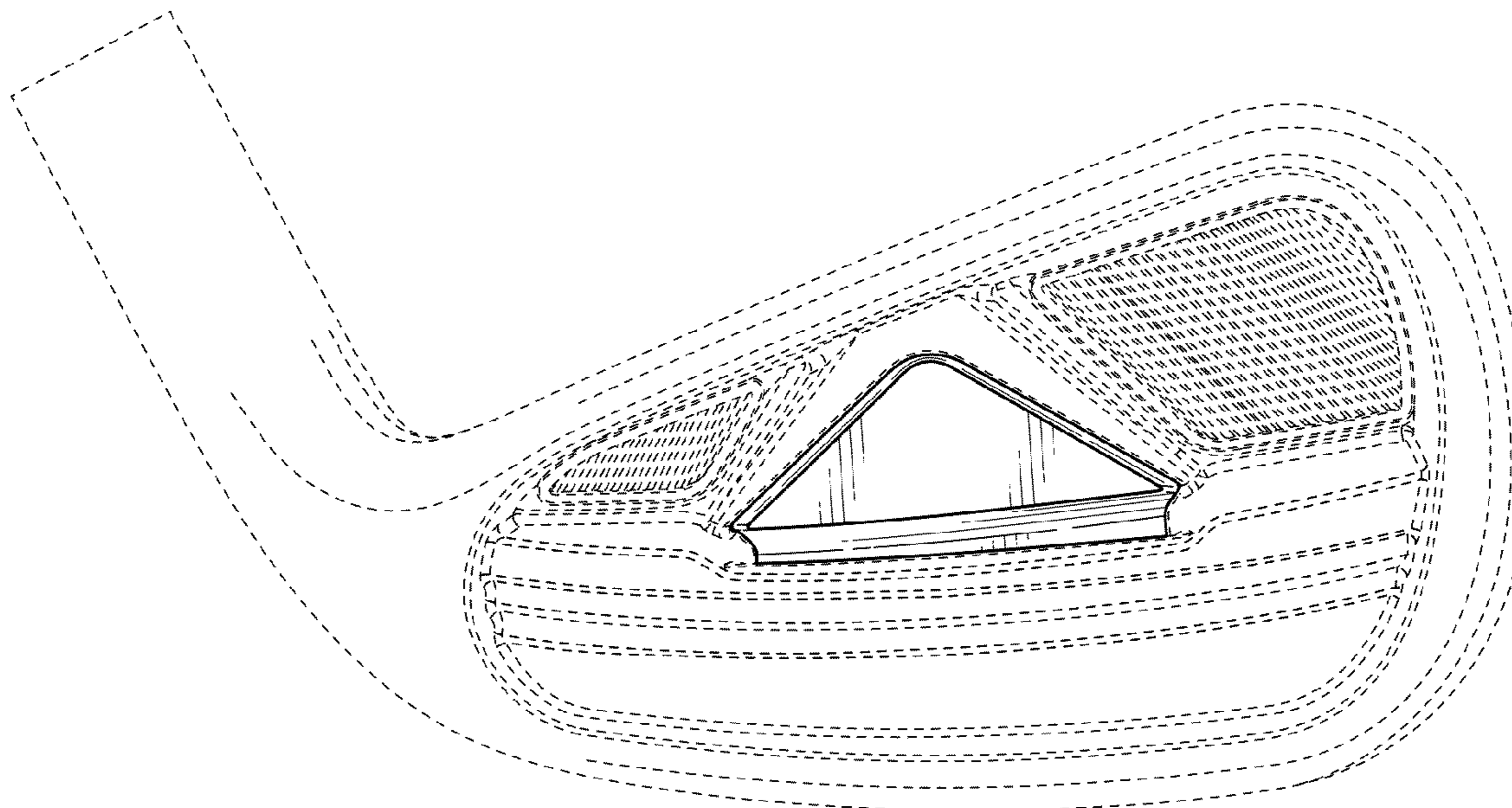

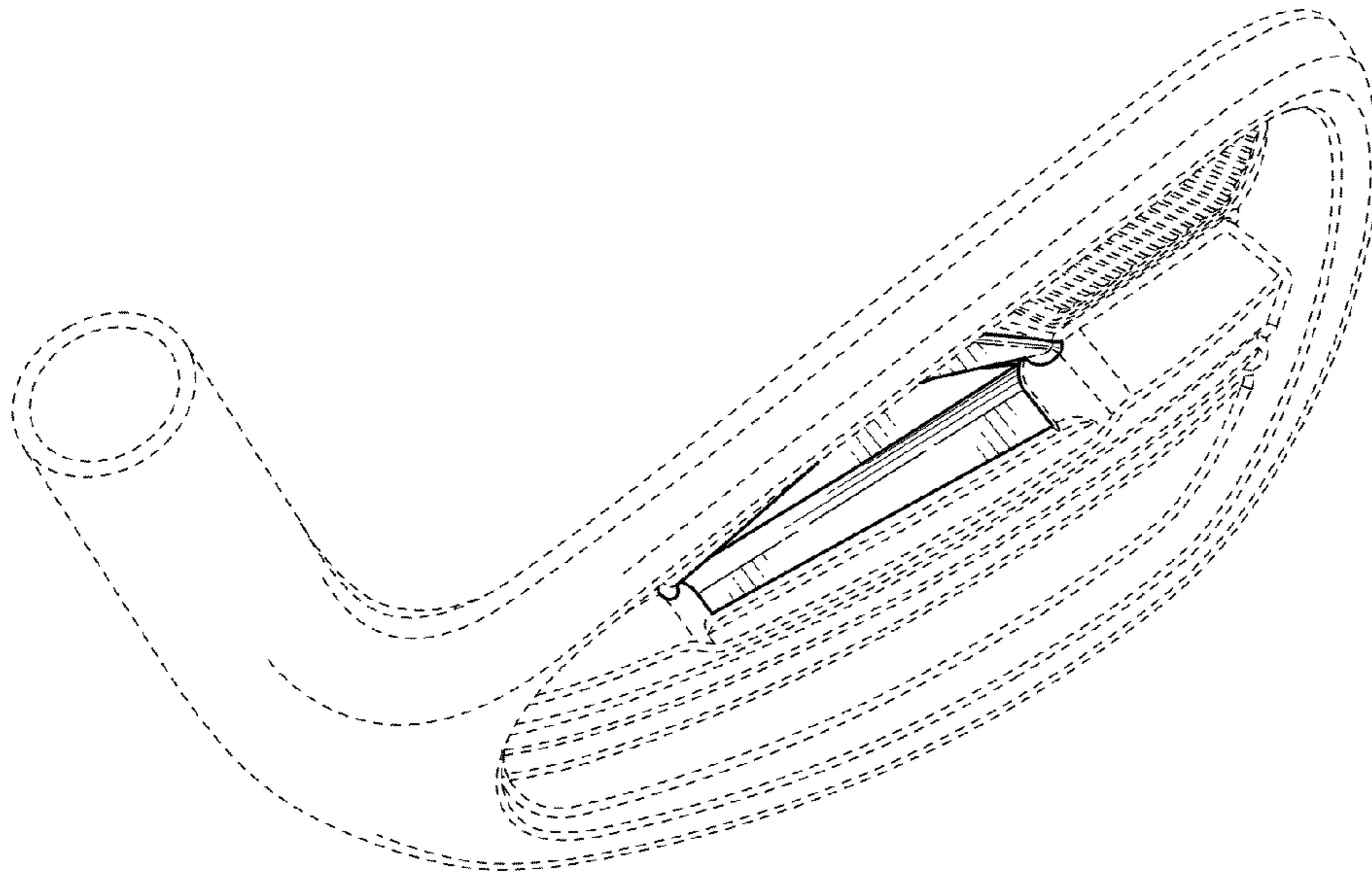

FIG. 1

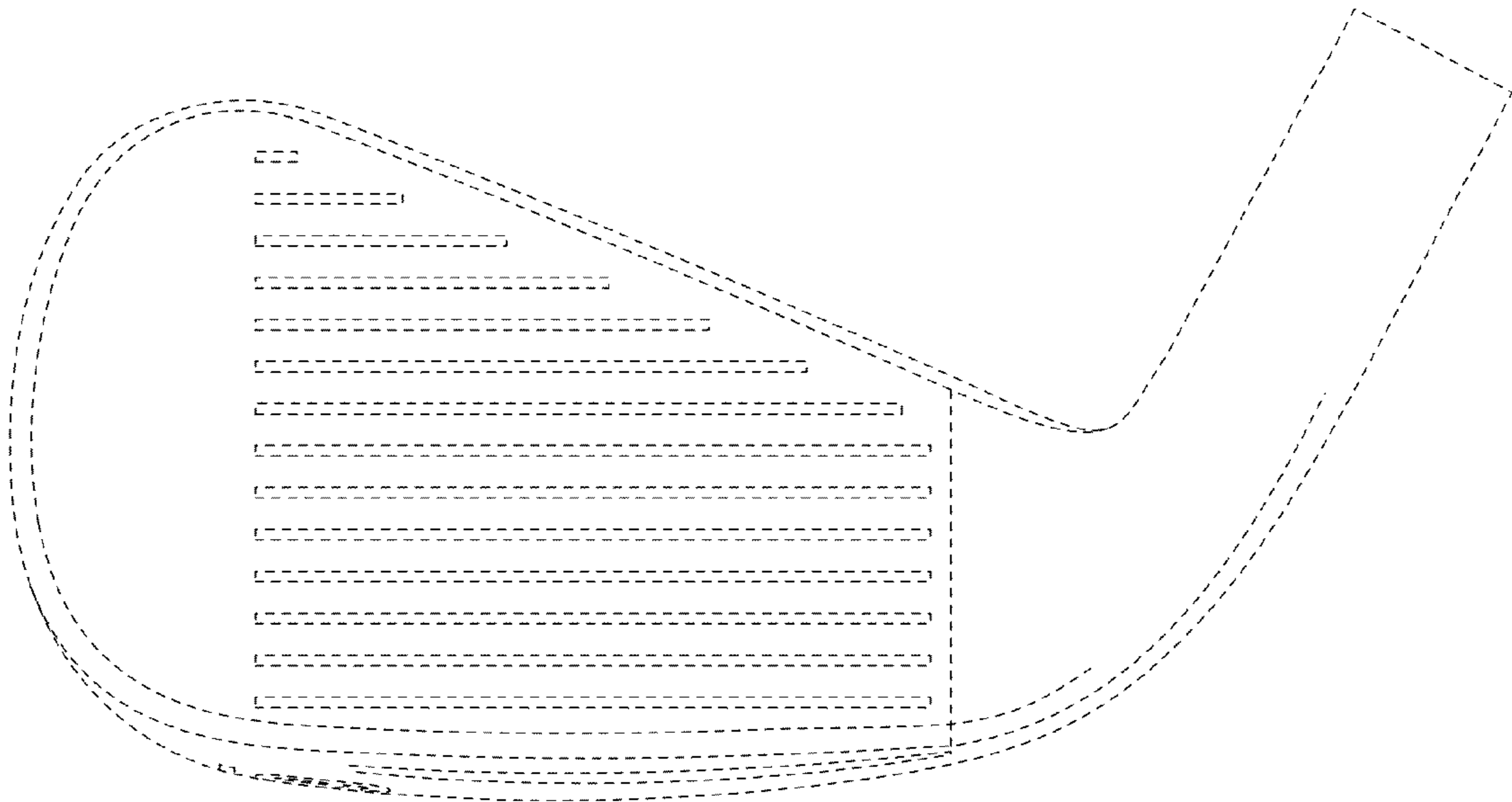

FIG. 2

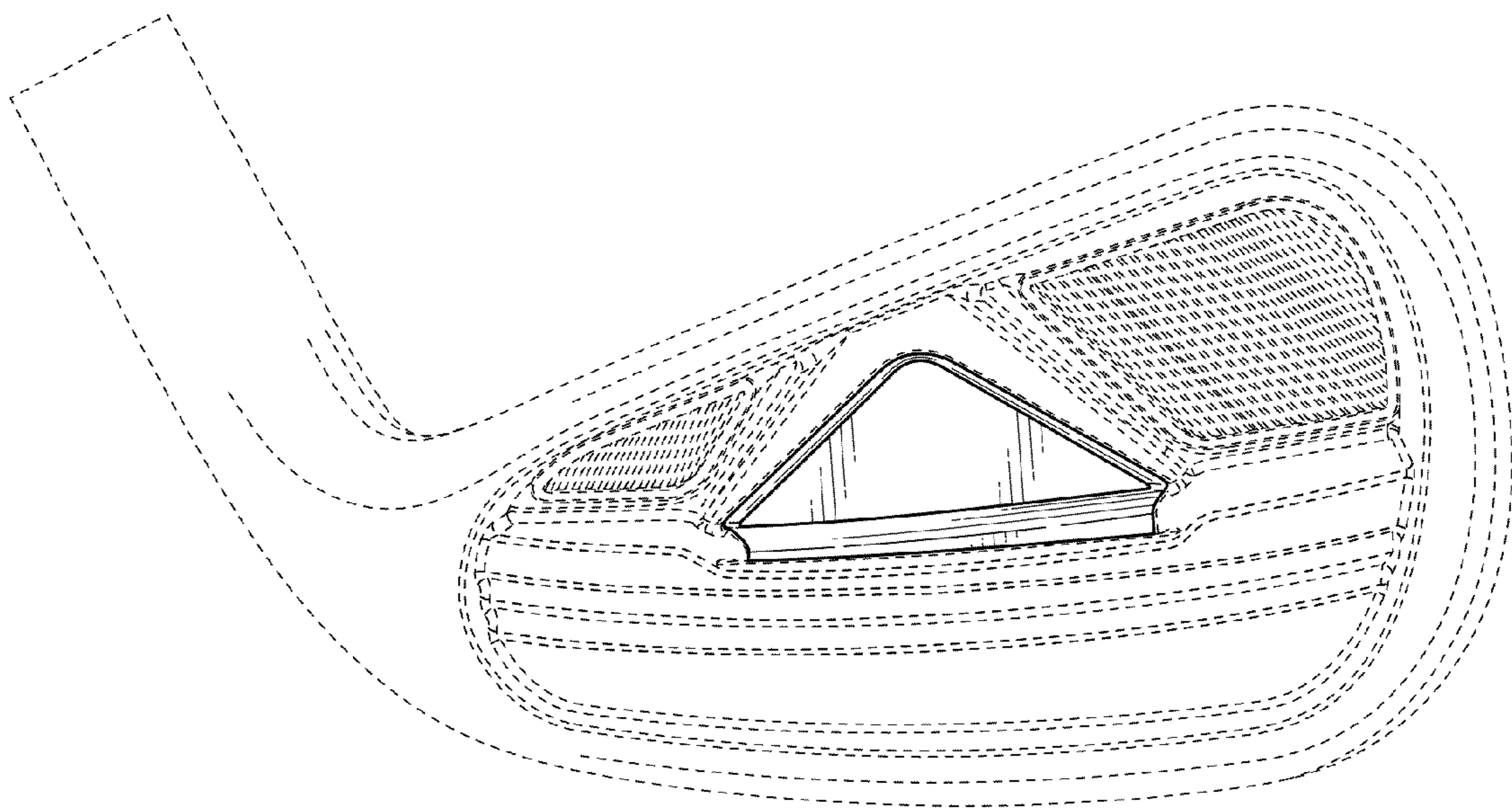

FIG. 3

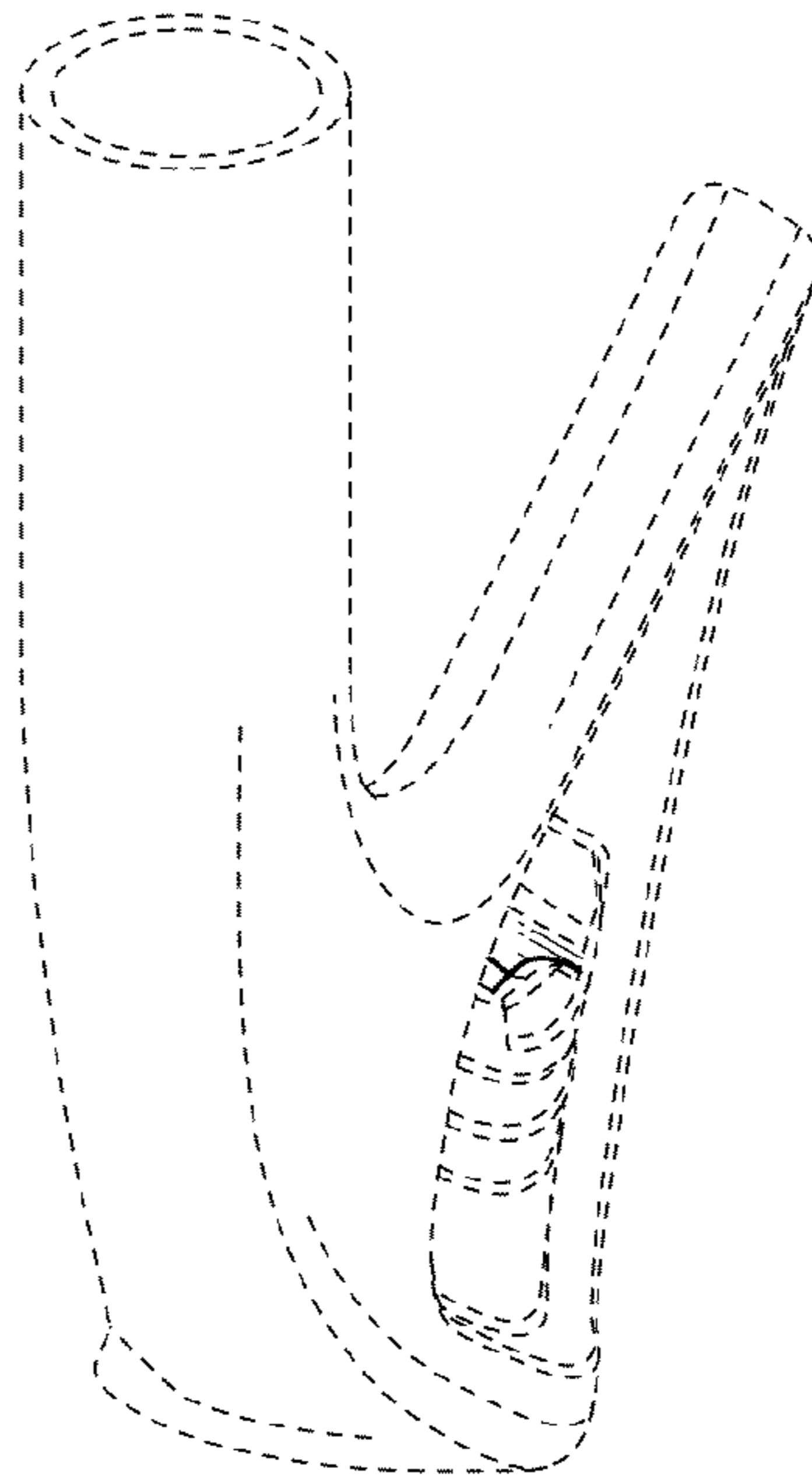

FIG. 4

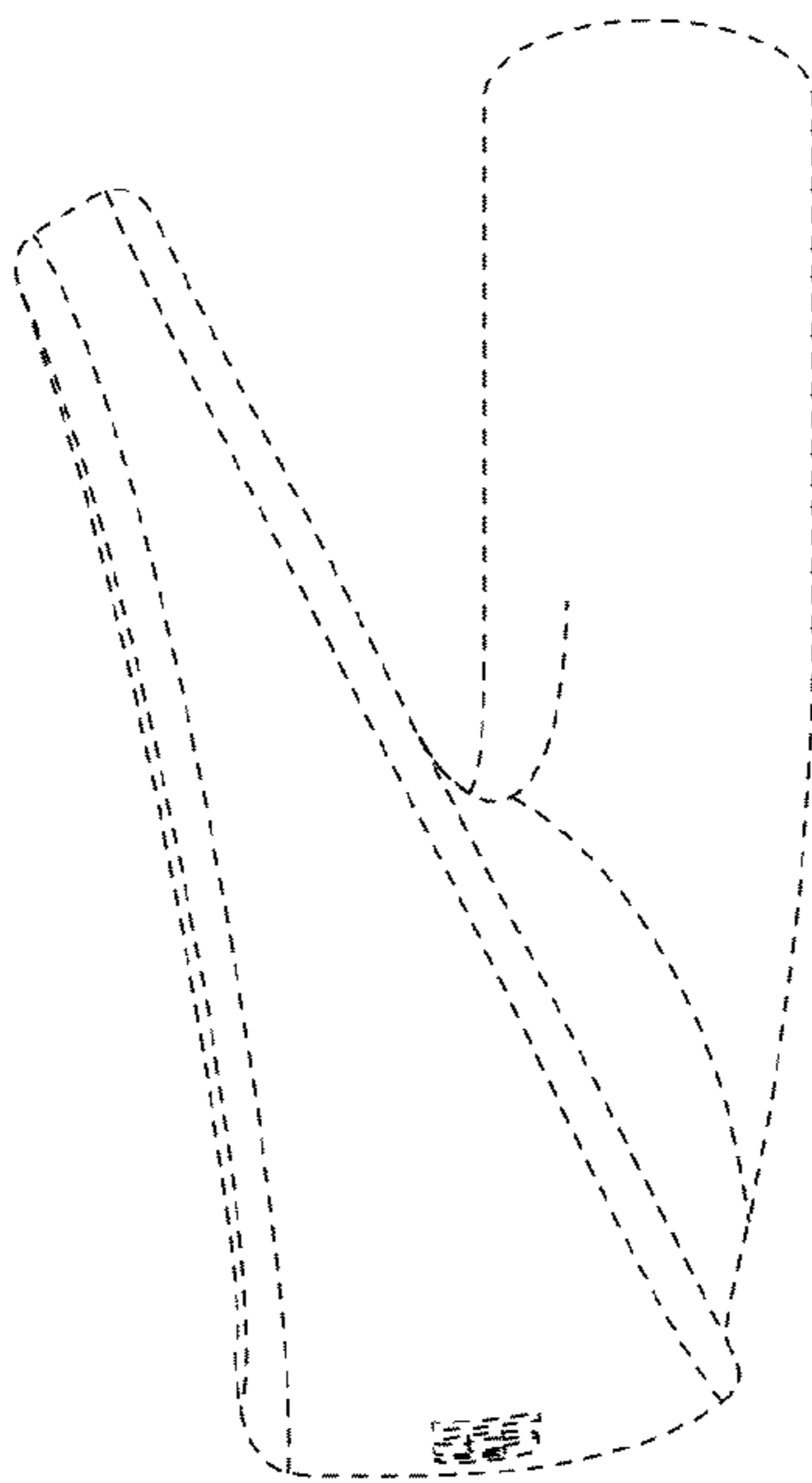

FIG. 5



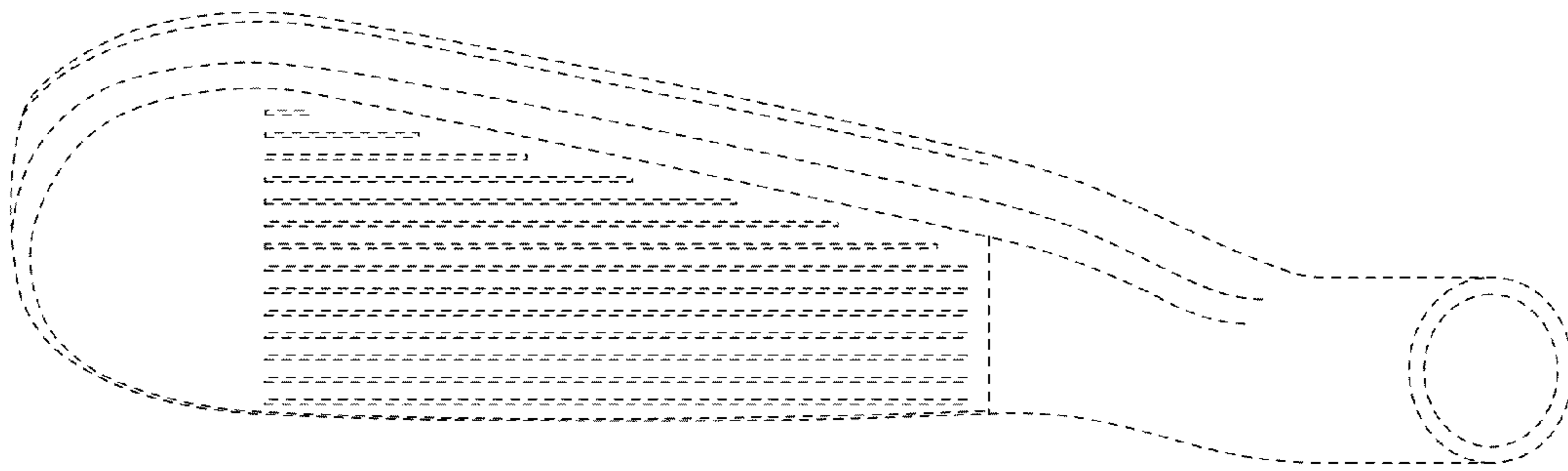

FIG. 6

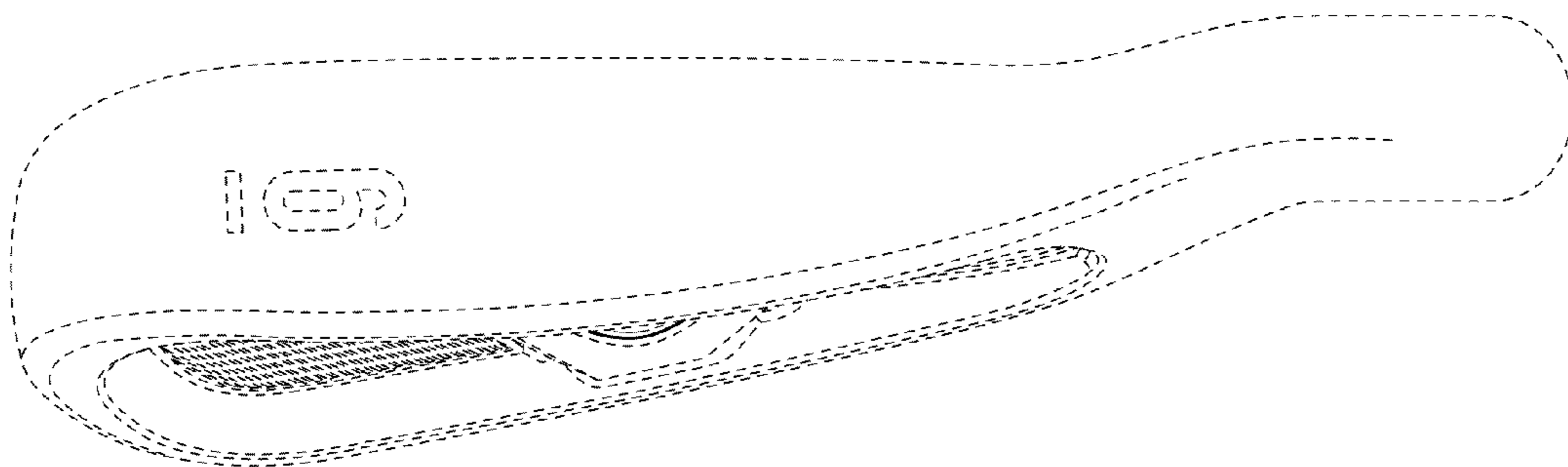

FIG. 7

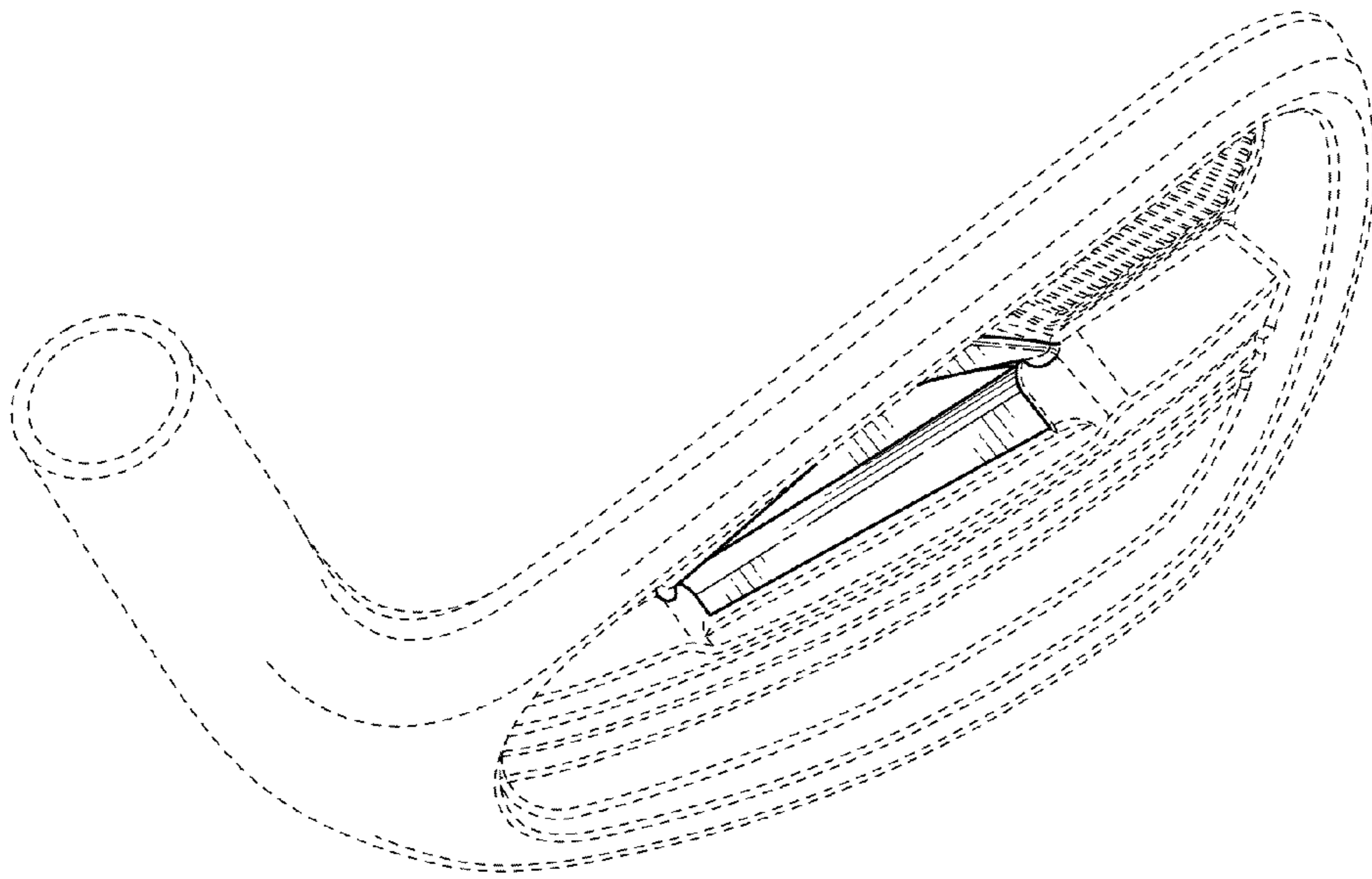

FIG. 8

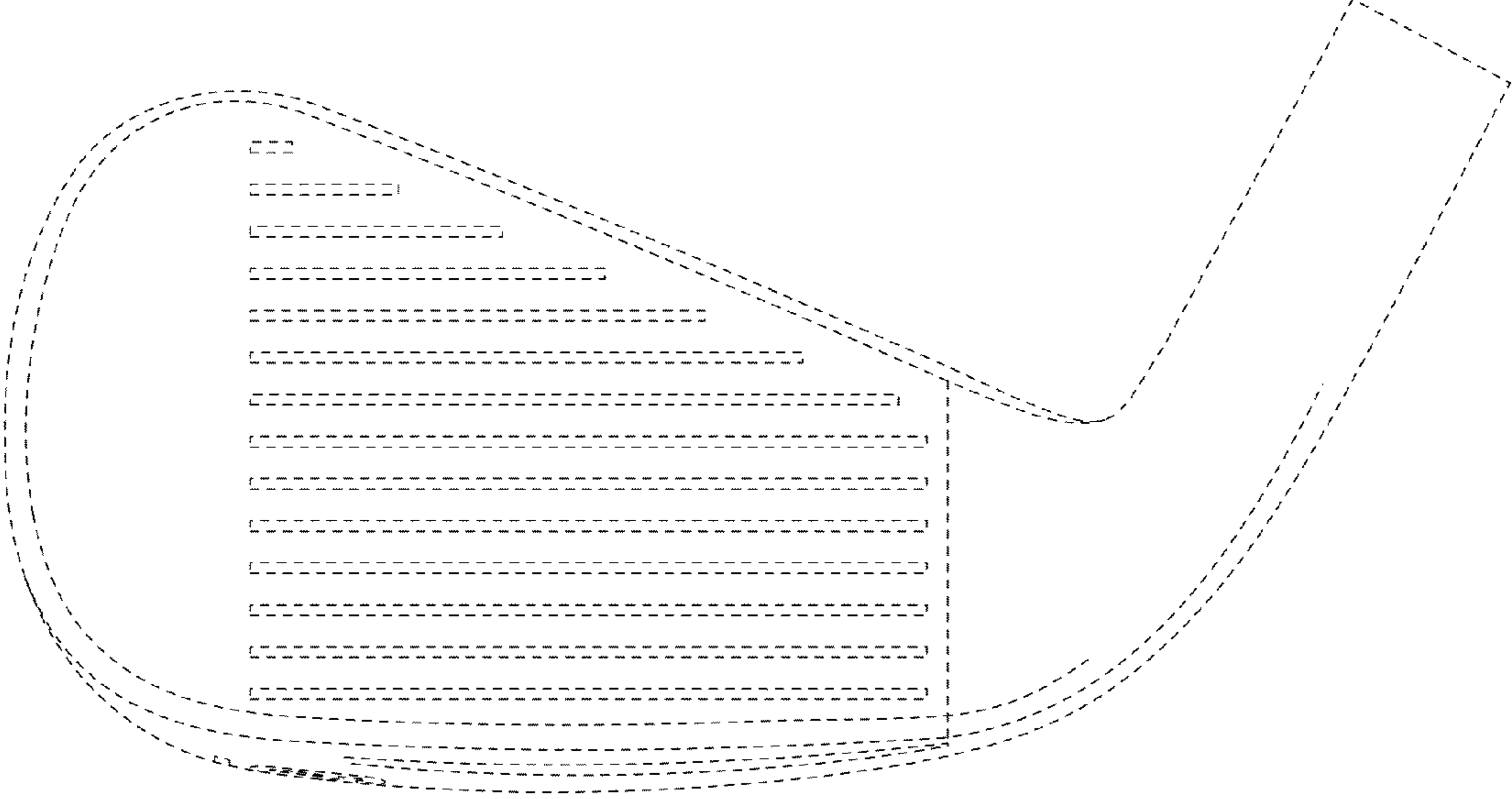

FIG. 9

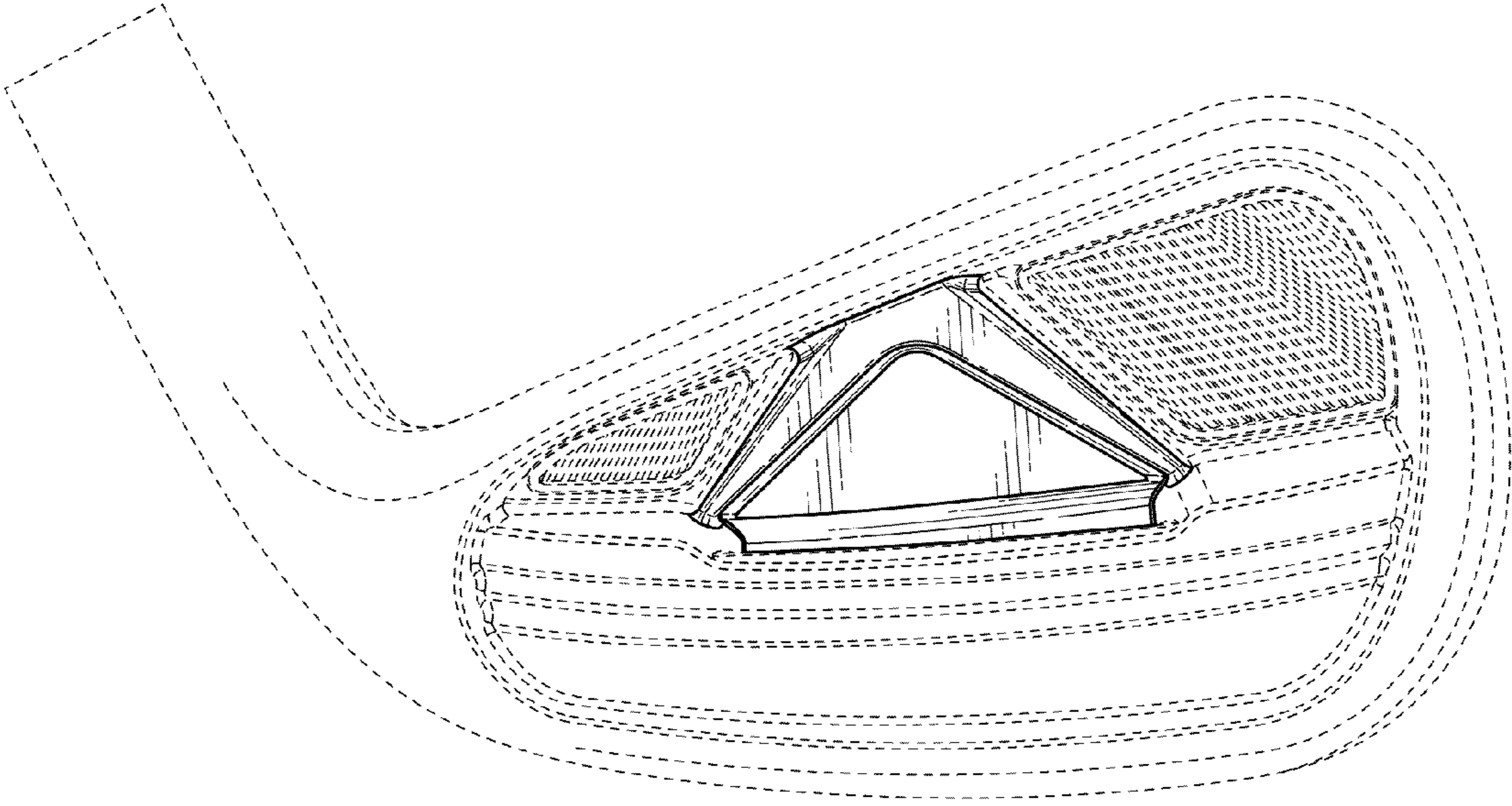

FIG. 10

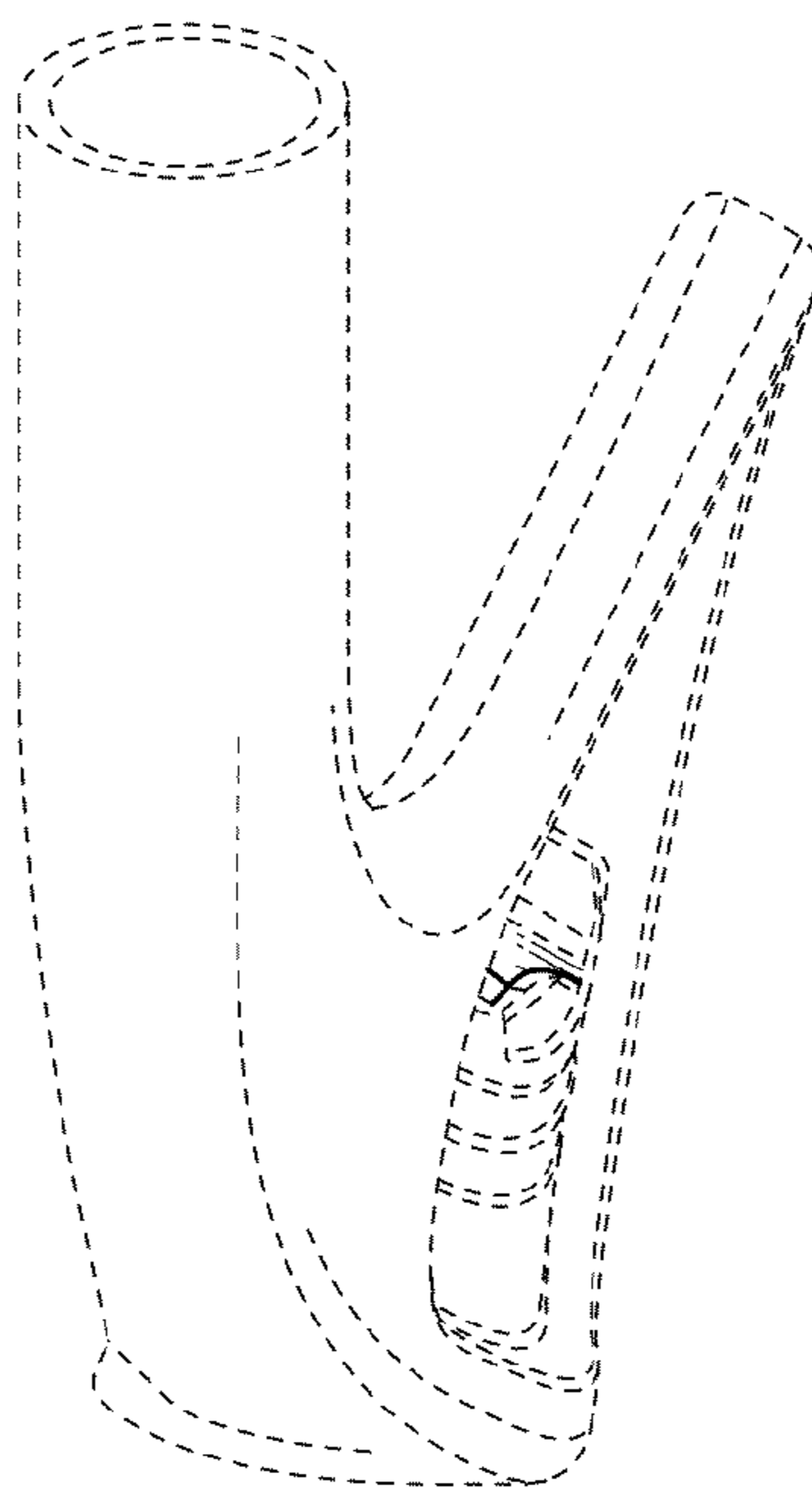

FIG. 11

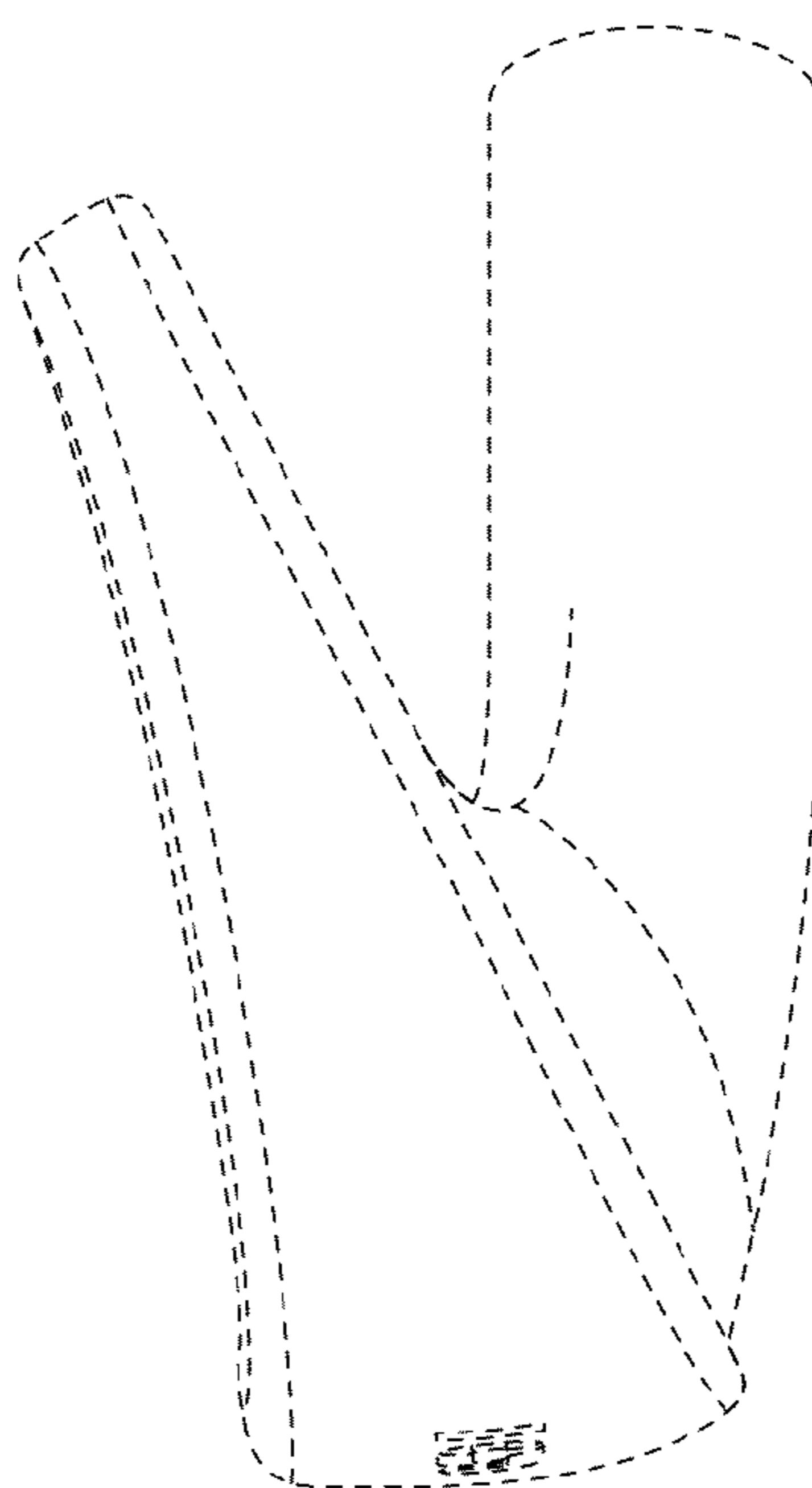

FIG. 12



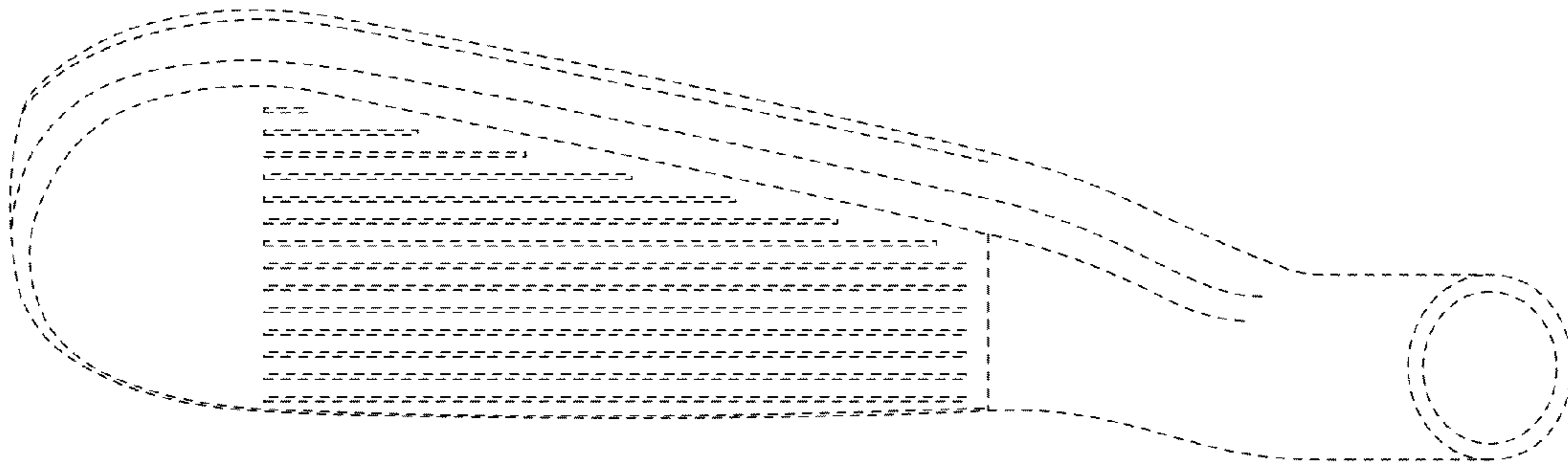

FIG. 13

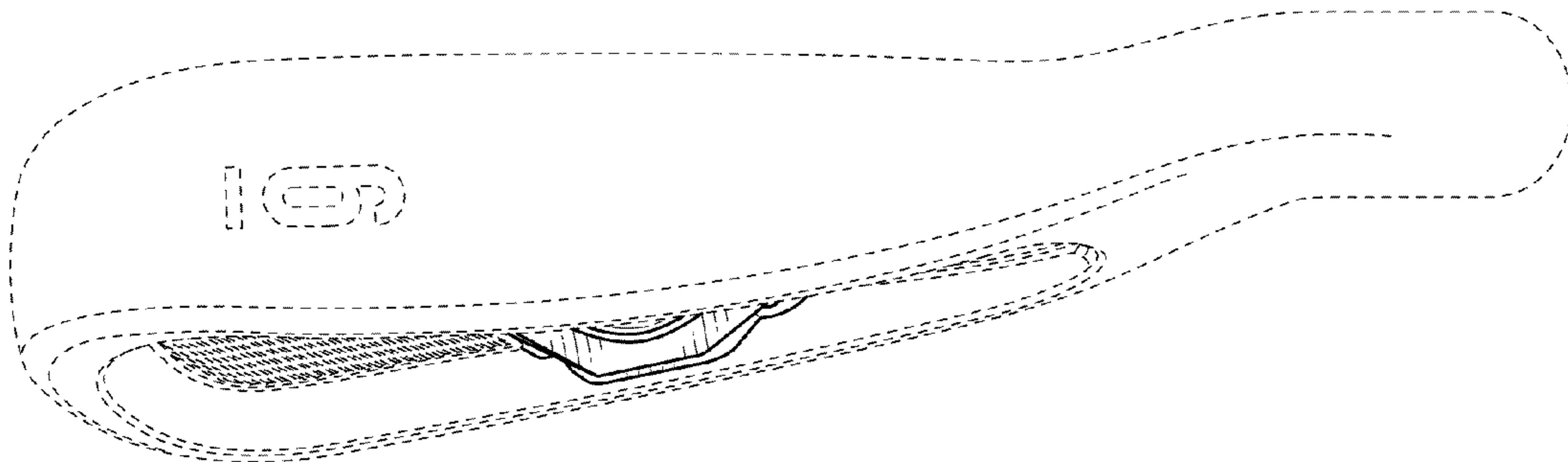

FIG. 14