



US00D716384S

(12) **United States Design Patent**
Norman et al.

(10) **Patent No.:** **US D716,384 S**
(45) **Date of Patent:** **** Oct. 28, 2014**

- (54) **BEAM COMPONENT FOR A CONSTRUCTION KIT**
- (71) Applicant: **Innovation First, Inc.**, Greenville, TX (US)
- (72) Inventors: **David Anthony Norman**, Greenville, TX (US); **Robert H. Mimplitch, III**, Rowlett, TX (US); **Paul David Copioli**, Rockwall, TX (US); **Gregory James Lavender**, Rockwall, TX (US); **Aren Calder Hill**, Rockford, IL (US); **Douglas Michael Galletti**, Allen, TX (US); **John Edward Vielkind-Neun**, Rockwall, TX (US); **Arthur Philip Dutra, IV**, Greenville, TX (US)
- (73) Assignee: **Innovation First, Inc.**, Greenville, TX (US)
- (**) Term: **14 Years**
- (21) Appl. No.: **29/483,317**
- (22) Filed: **Feb. 27, 2014**

Related U.S. Application Data

- (62) Division of application No. 29/451,721, filed on Apr. 8, 2013, now Pat. No. Des. 707,306.
- (51) **LOC (10) Cl.** **21-01**
- (52) **U.S. Cl.**
USPC **D21/504**; D21/486
- (58) **Field of Classification Search**
CPC A63H 33/00; A63H 33/04; A63H 33/06;
A63H 33/08; A63H 33/10; A63H 33/12;
A63H 33/14; A63F 9/08; A63F 9/12; G09B
1/36
USPC D21/484, 485, 486, 488, 489, 491, 494,
D21/495, 499, 500-504; 446/69, 85,
446/102-128; 434/208, 259, 403; 273/153,
273/156, 160; 428/174
See application file for complete search history.

(56) **References Cited**

U.S. PATENT DOCUMENTS

D374,257 S * 10/1996 Schmidt et al. D21/486

D374,465 S 10/1996 Schmidt
(Continued)

Primary Examiner — Cynthia M Chin

(74) *Attorney, Agent, or Firm* — Adam K. Sacharoff; Much Shelist

(57) **CLAIM**

The ornamental design for a beam component for a construction kit, as shown and described.

DESCRIPTION

FIG. 1 is a front perspective view of a beam component for a construction kit in accordance with an embodiment of the invention;

FIG. 2 is a rear perspective view of FIG. 1;

FIG. 3 is a top side perspective view of FIG. 1;

FIG. 4 is a bottom side view of FIG. 1;

FIG. 5 is a right side view of FIG. 1;

FIG. 6 is a left side view of FIG. 1;

FIG. 7 is a front side view of FIG. 1;

FIG. 8 is a rear side view of FIG. 1;

FIG. 9 is a front perspective view of a beam component for a construction kit in accordance with another embodiment of the invention;

FIG. 10 is a rear perspective view of FIG. 9;

FIG. 11 is a top side perspective view of FIG. 9;

FIG. 12 is a bottom side view of FIG. 9;

FIG. 13 is a right side view of FIG. 9;

FIG. 14 is a left side view of FIG. 9;

FIG. 15 is a front side view of FIG. 9;

FIG. 16 is a rear side view of FIG. 9;

FIG. 17 is a front perspective view of a beam component for a construction kit in accordance with another embodiment of the invention;

FIG. 18 is a rear perspective view of FIG. 17;

FIG. 19 is a top side perspective view of FIG. 17;

FIG. 20 is a bottom side view of FIG. 17;

FIG. 21 is a right side view of FIG. 17;

FIG. 22 is a left side view of FIG. 17;

FIG. 23 is a front side view of FIG. 17; and,

FIG. 24 is a rear side view of FIG. 17.

The broken lines are for environmental purposes only and form no part of the claimed embodiments and design.

1 Claim, 24 Drawing Sheets

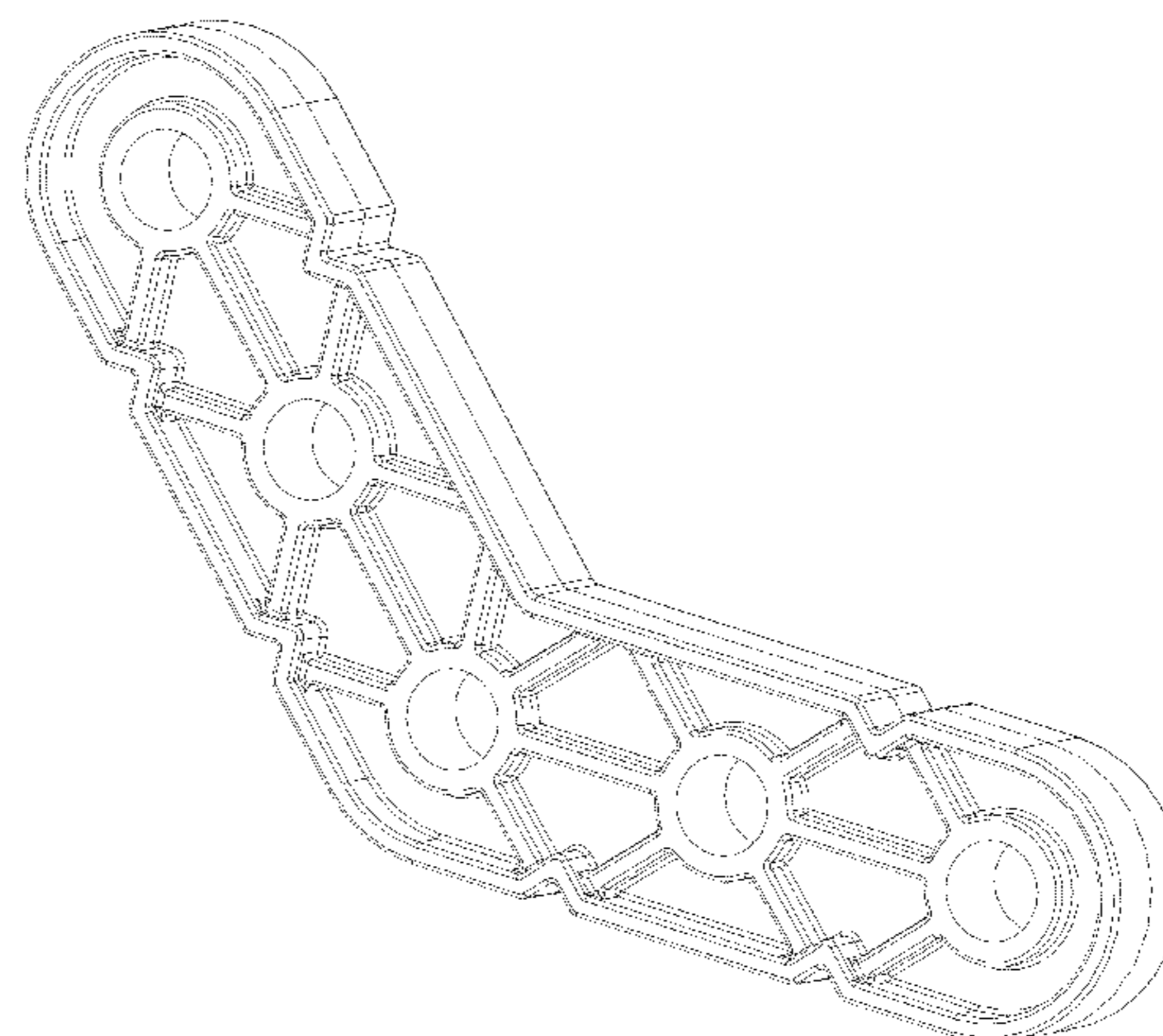
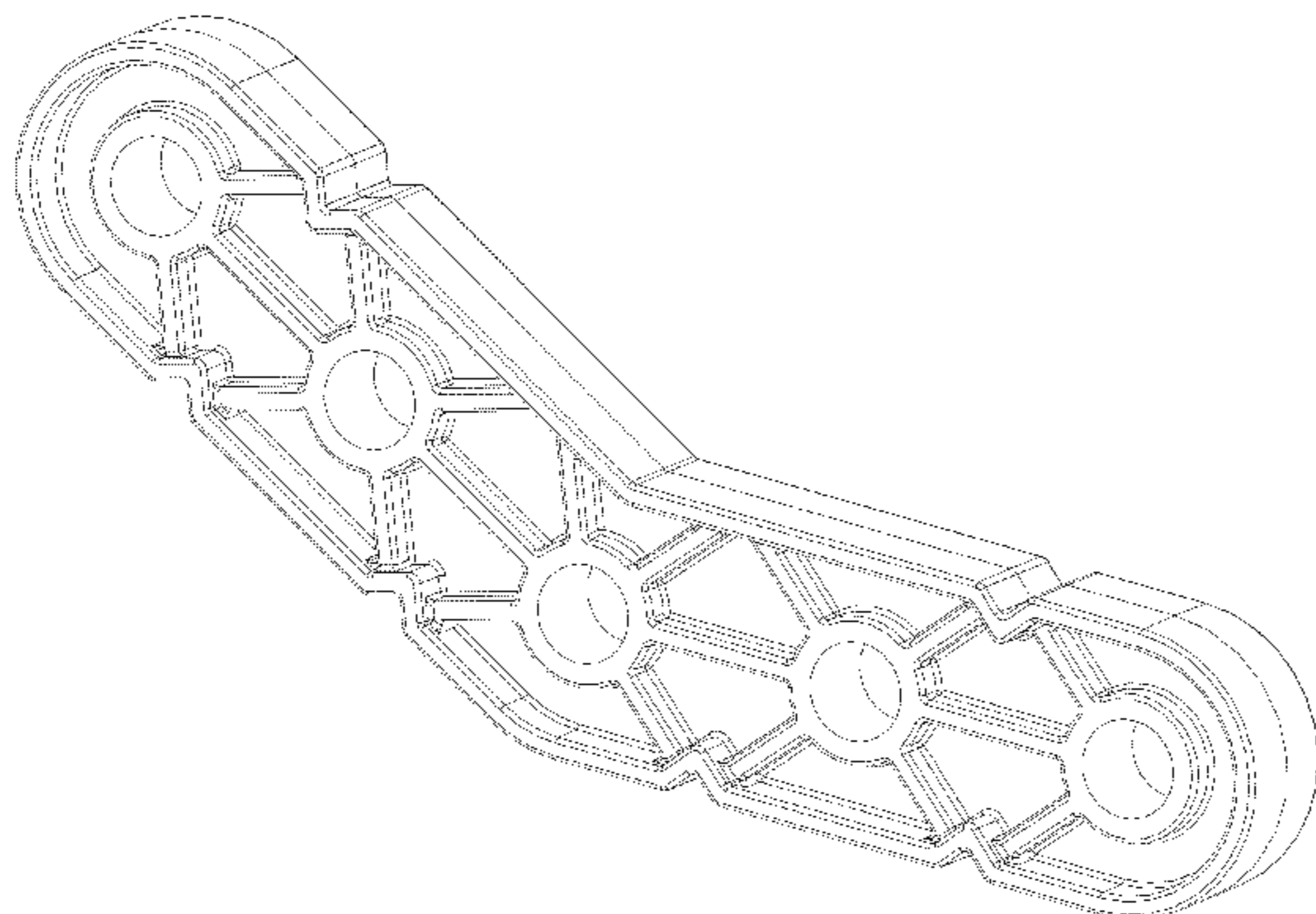

(56)

References Cited

U.S. PATENT DOCUMENTS

5,816,882 A 10/1998 Geugan et al.
D406,611 S 3/1999 Holm
D528,608 S 9/2006 Kossmann

D553,199 S 10/2007 Glickman et al.
7,517,270 B2 * 4/2009 Marzetta 446/122
D603,976 S * 11/2009 Pearce D25/114
D611,107 S 3/2010 Schmidt
D706,363 S * 6/2014 Norman et al. D21/491

* cited by examiner

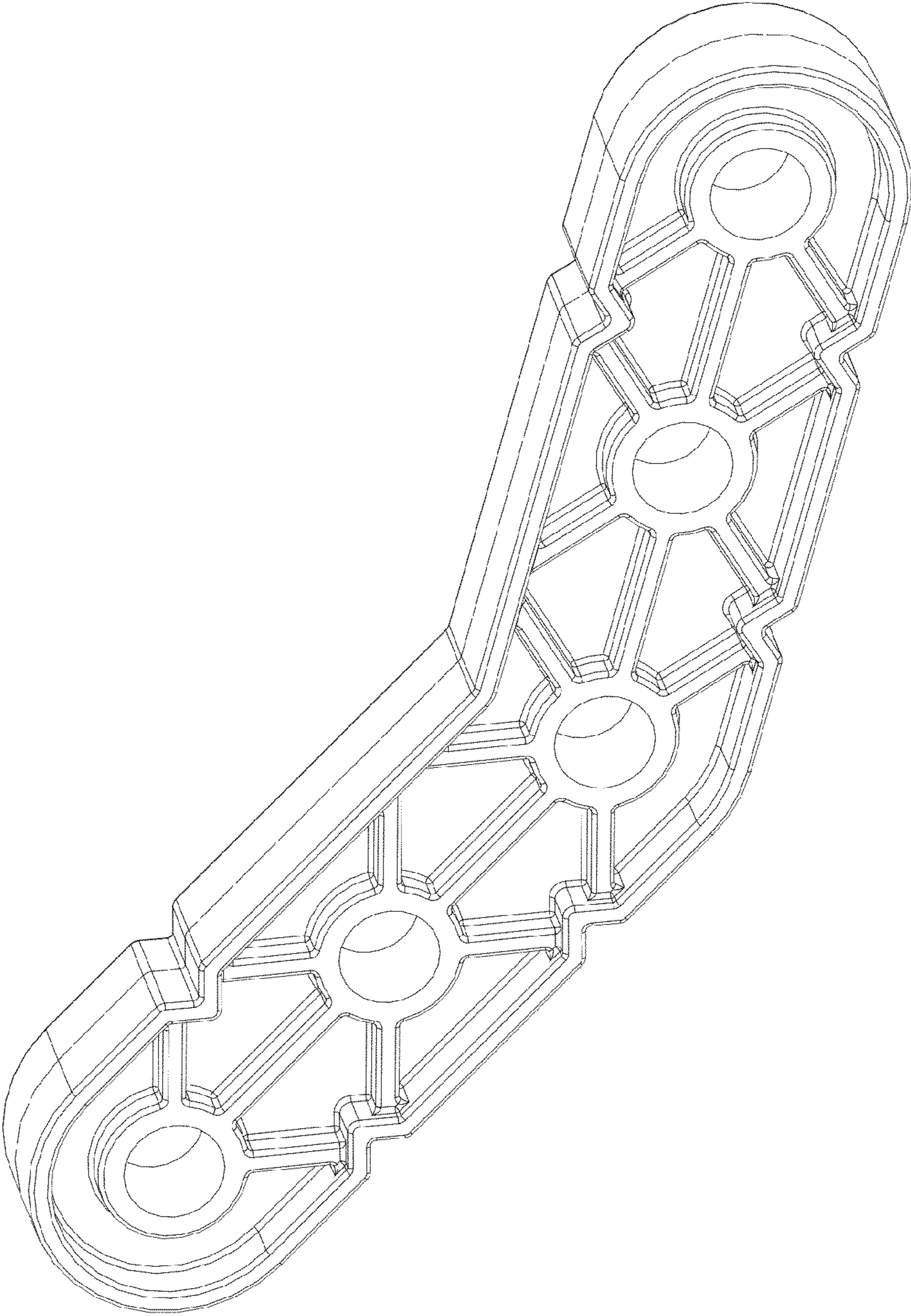

FIGURE 1

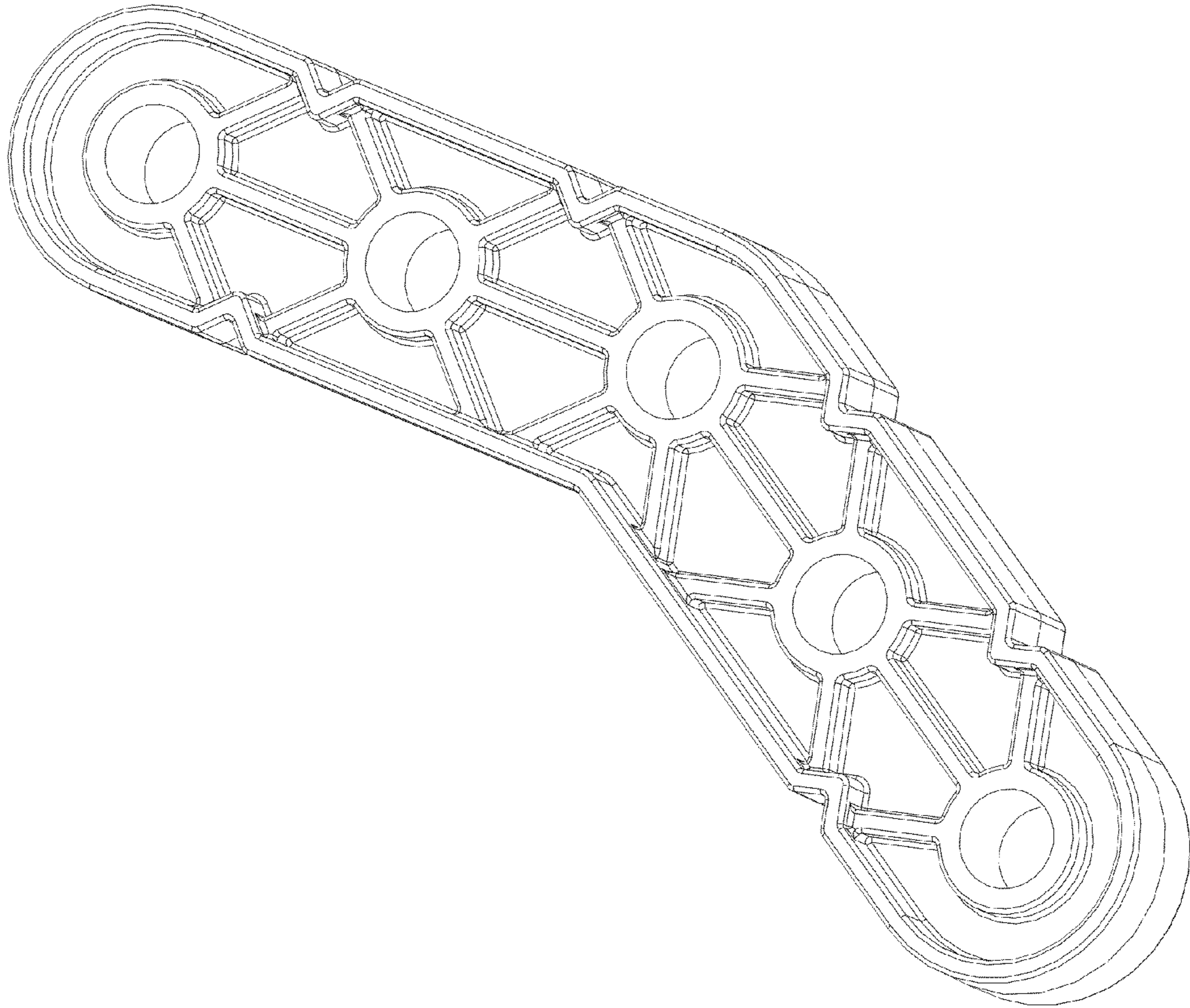

FIGURE 2

FIGURE 3

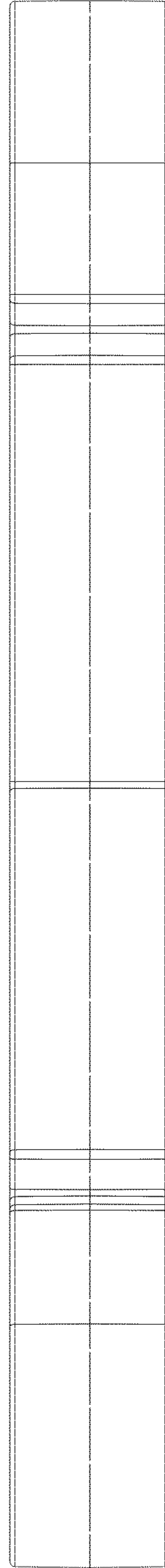
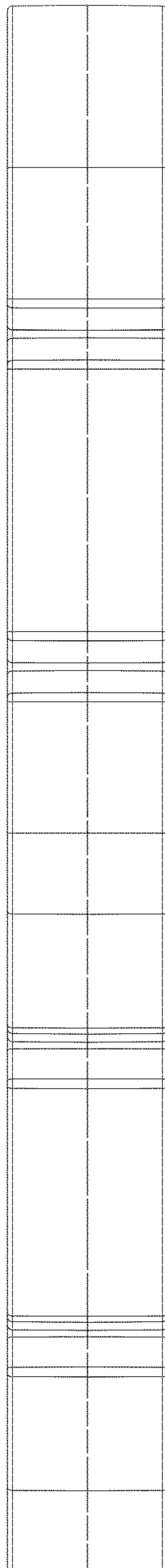

FIGURE 4



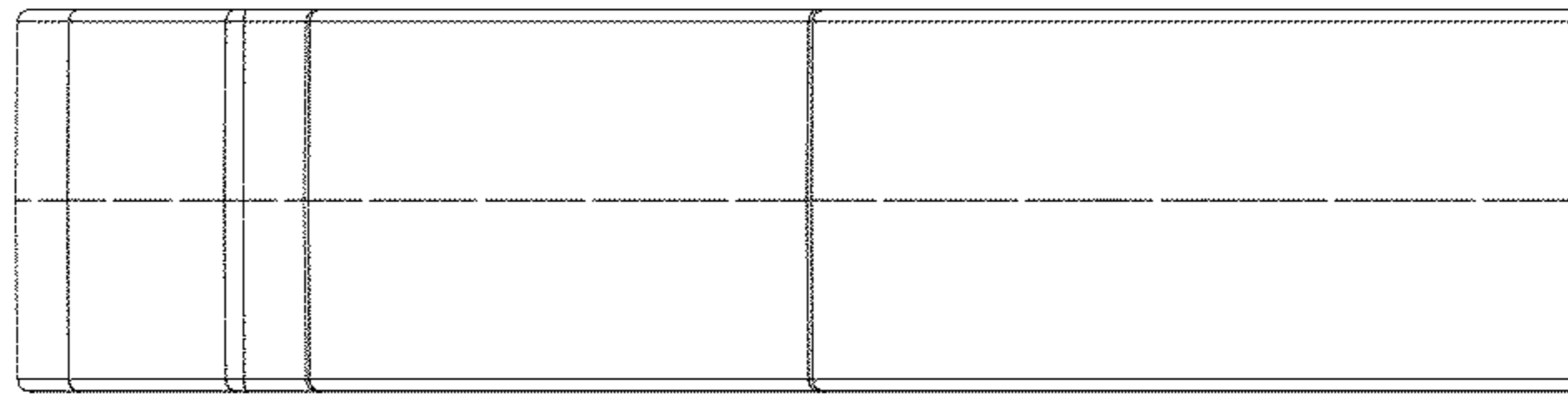

FIGURE 5

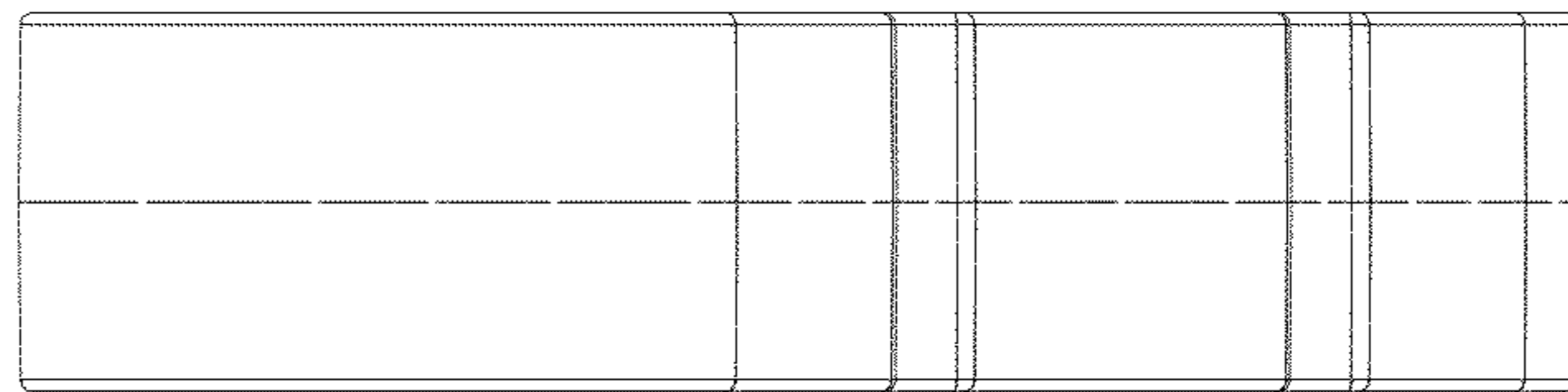

FIGURE 6

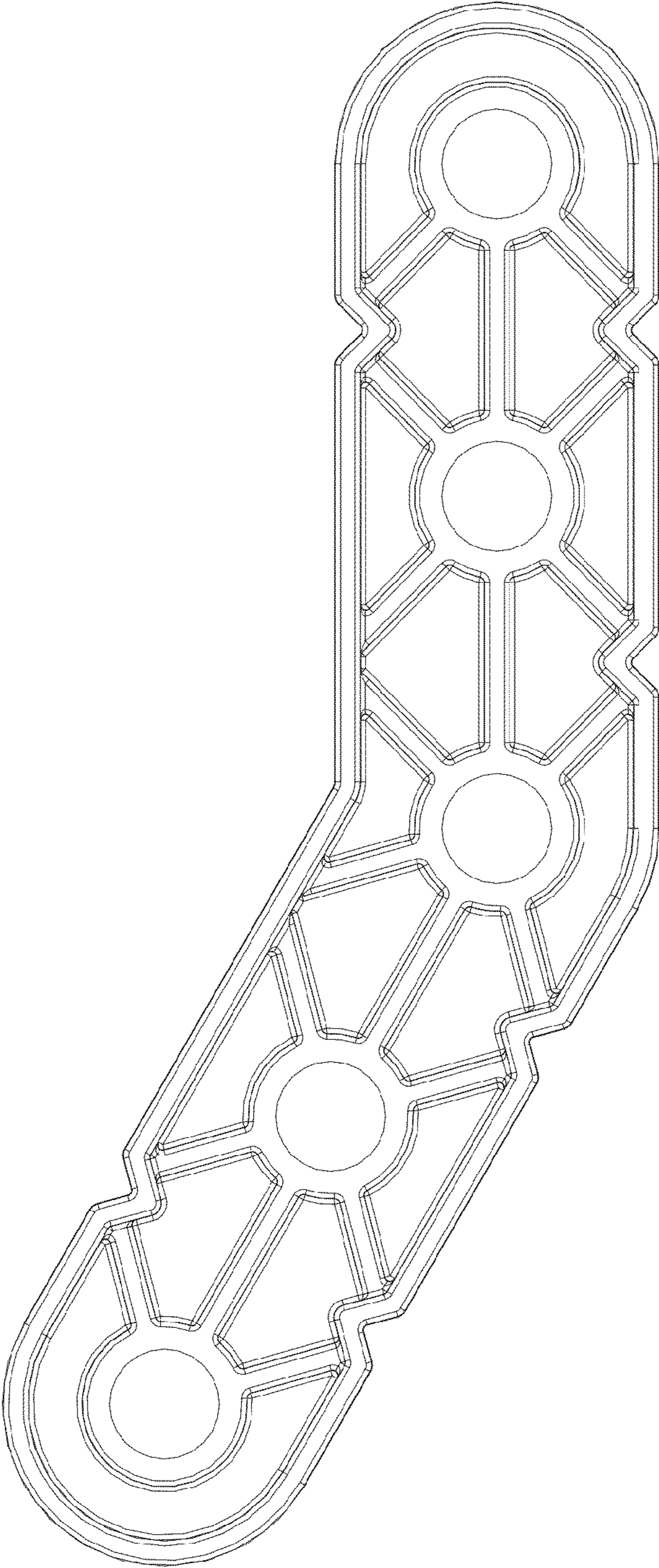

FIGURE 7

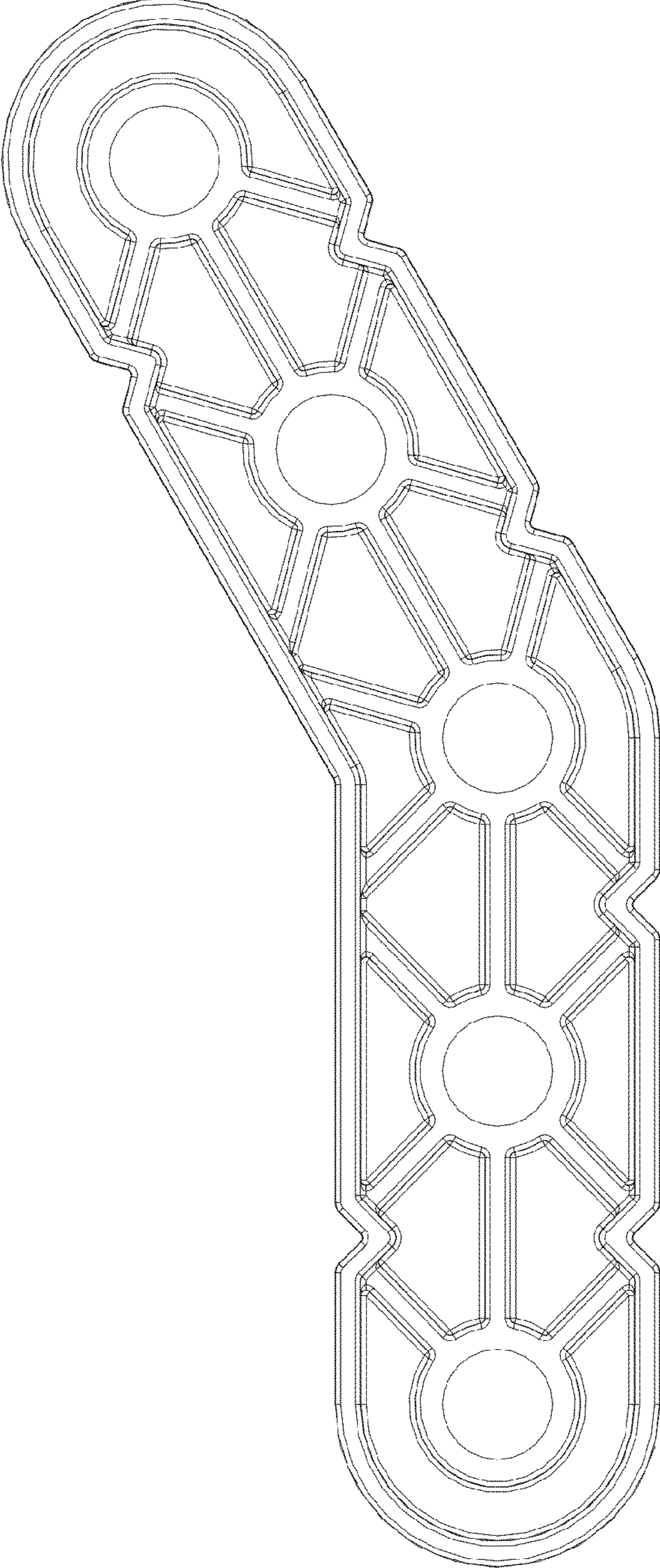

FIGURE 8

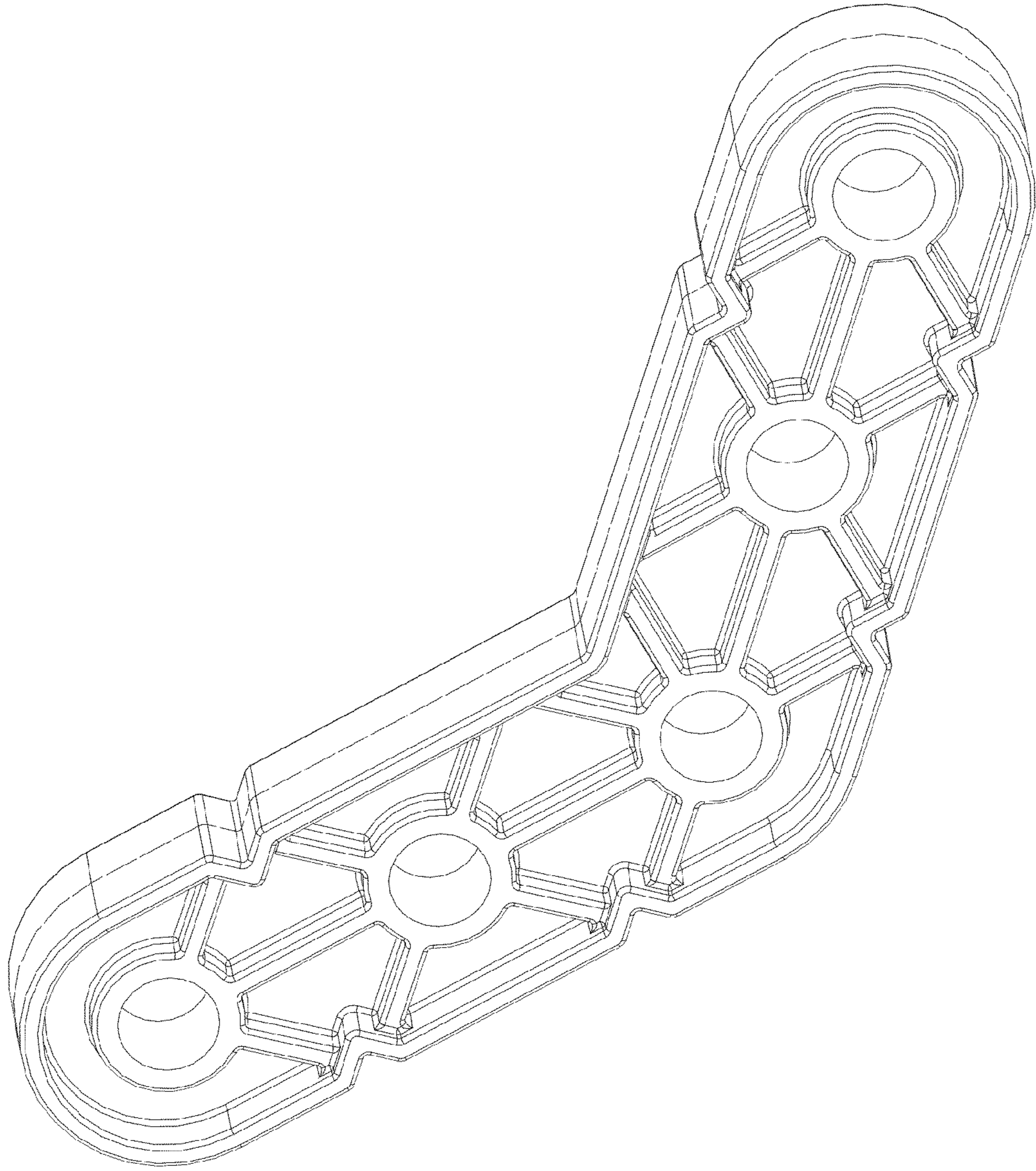

FIGURE 9

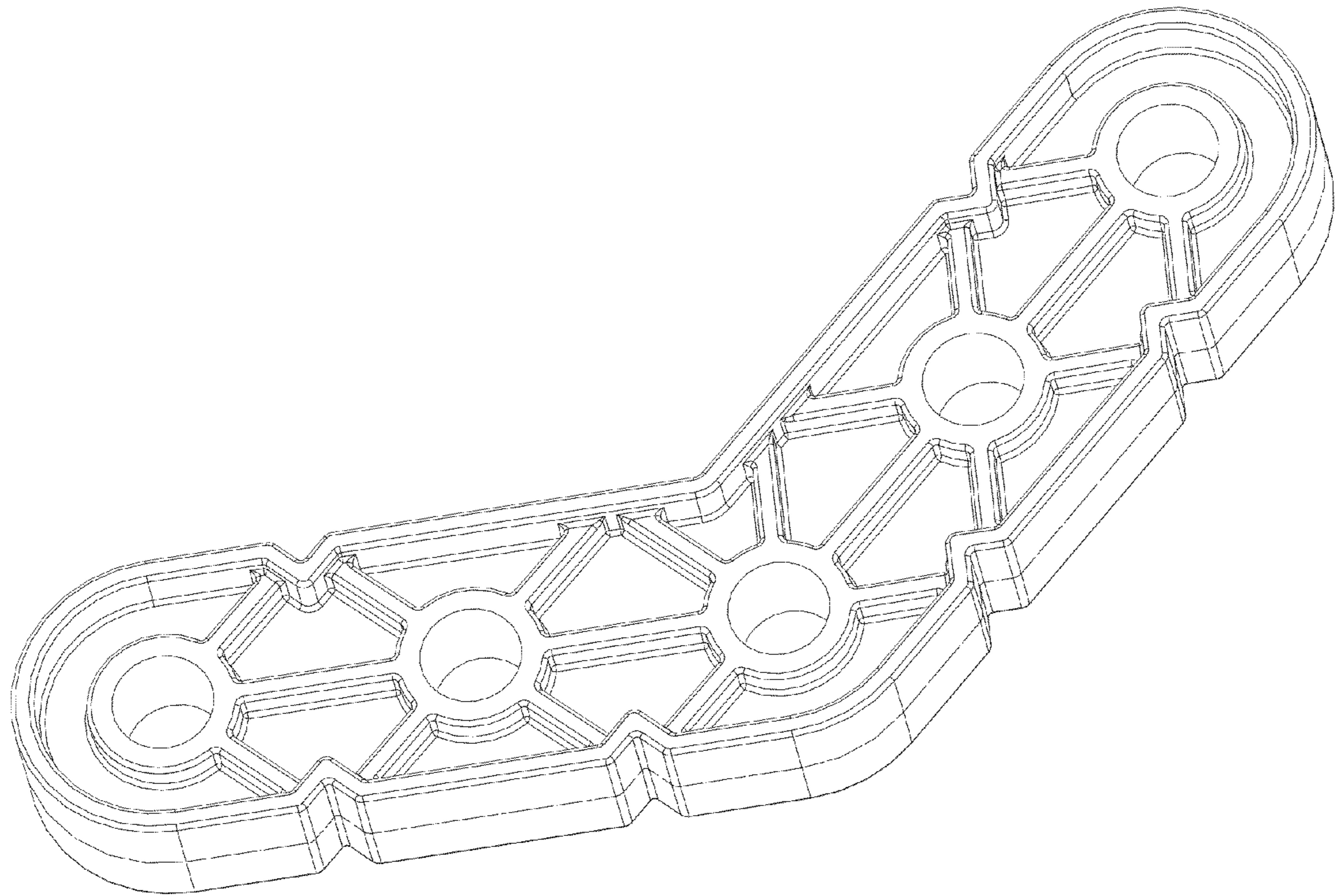
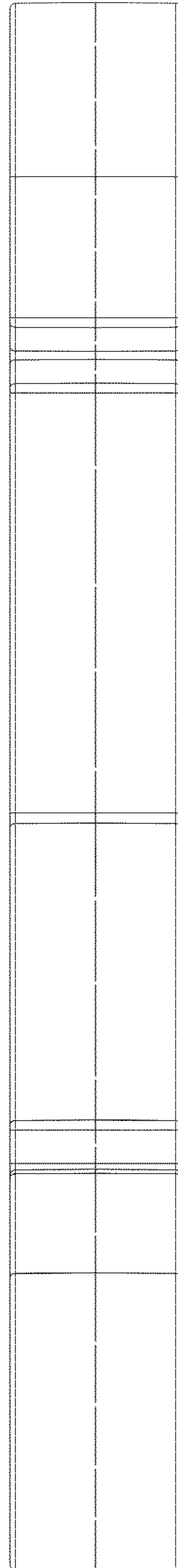

FIGURE 10

FIGURE 11



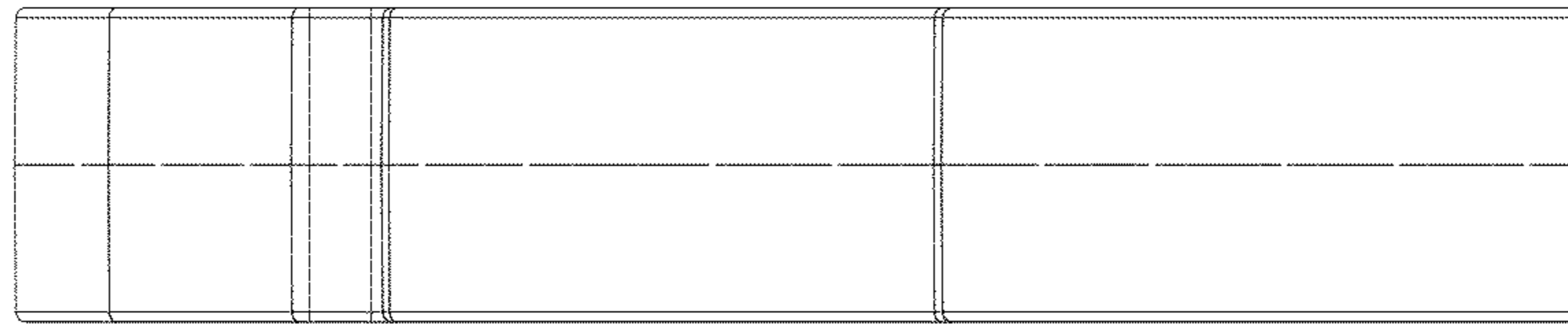

FIGURE 13

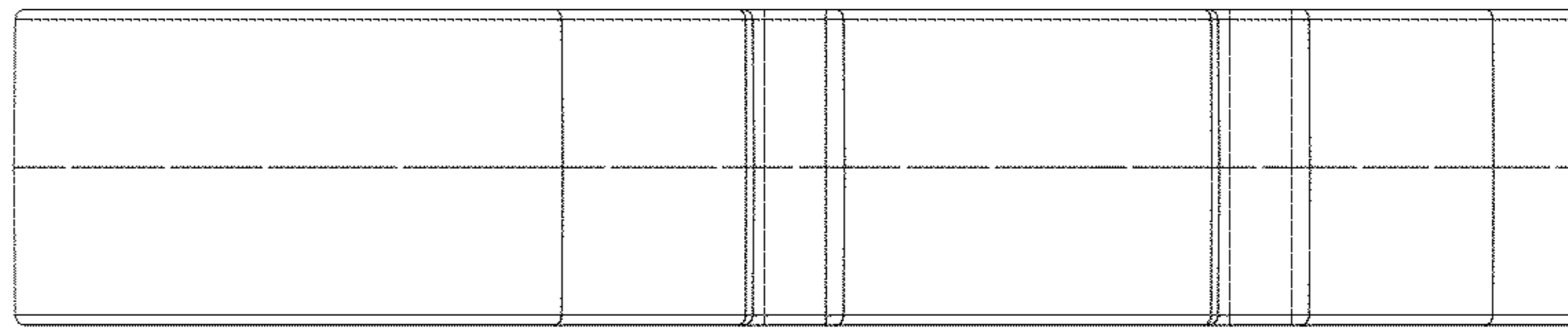

FIGURE 14

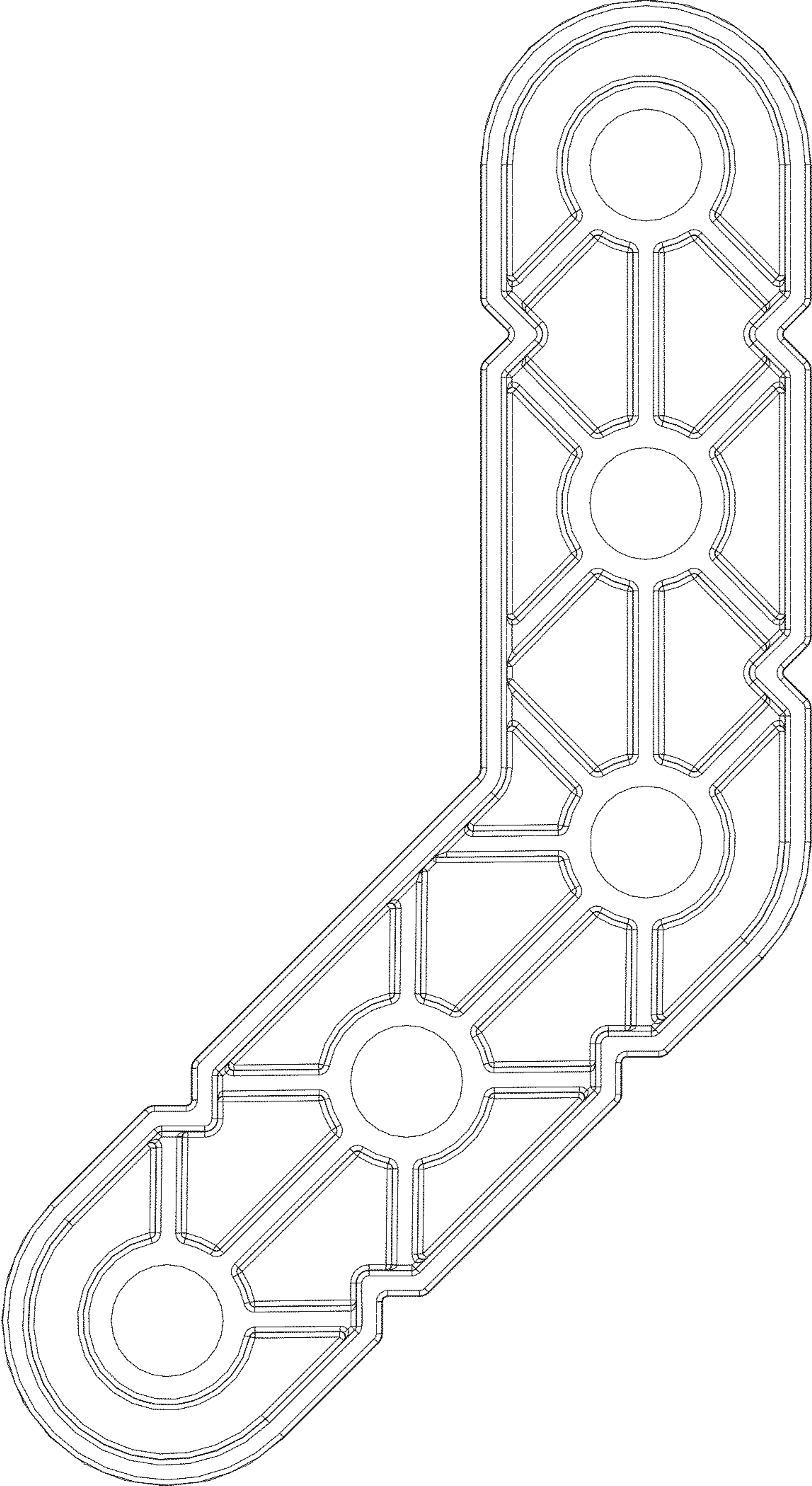

FIGURE 15

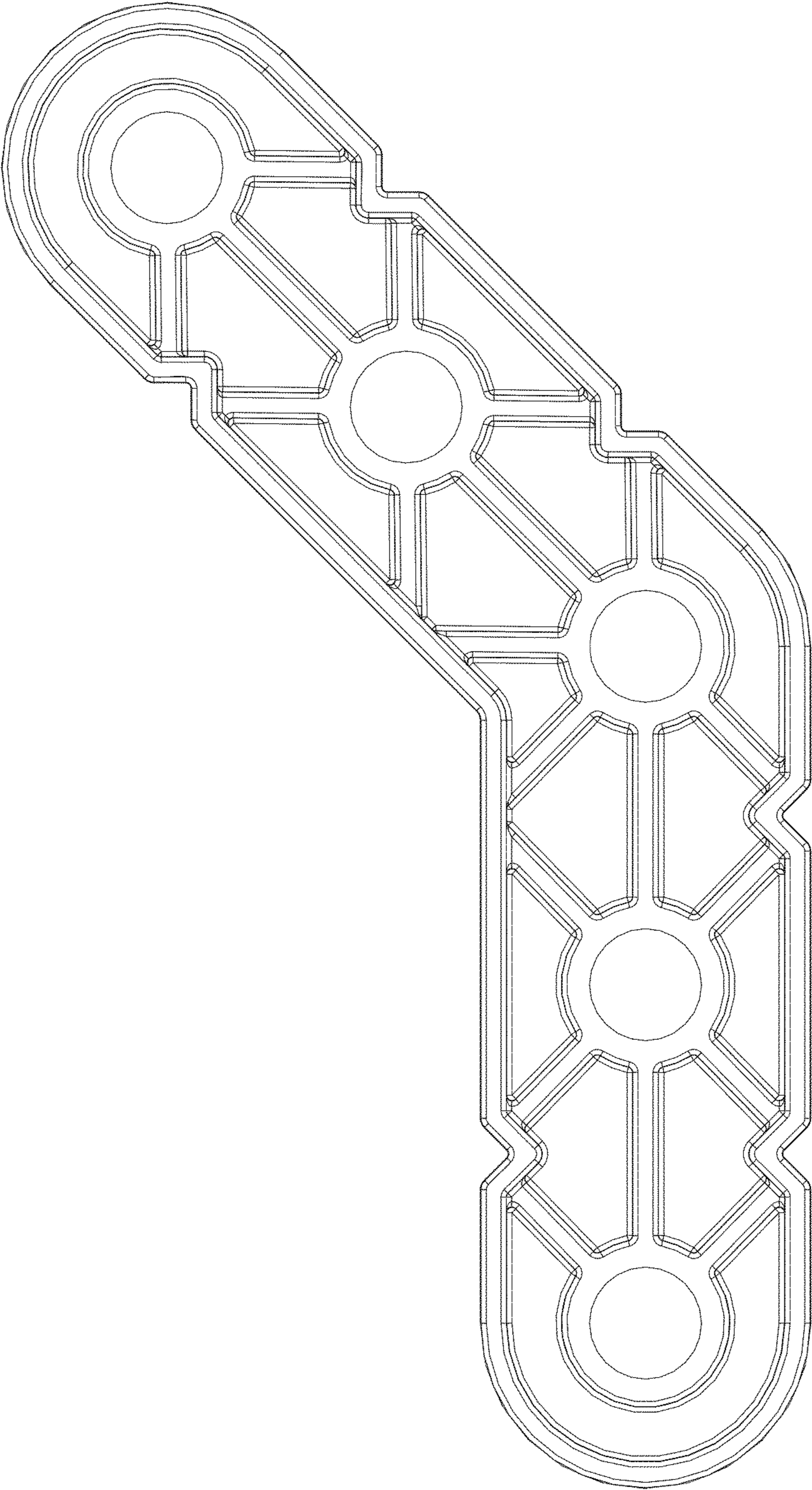

FIGURE 16

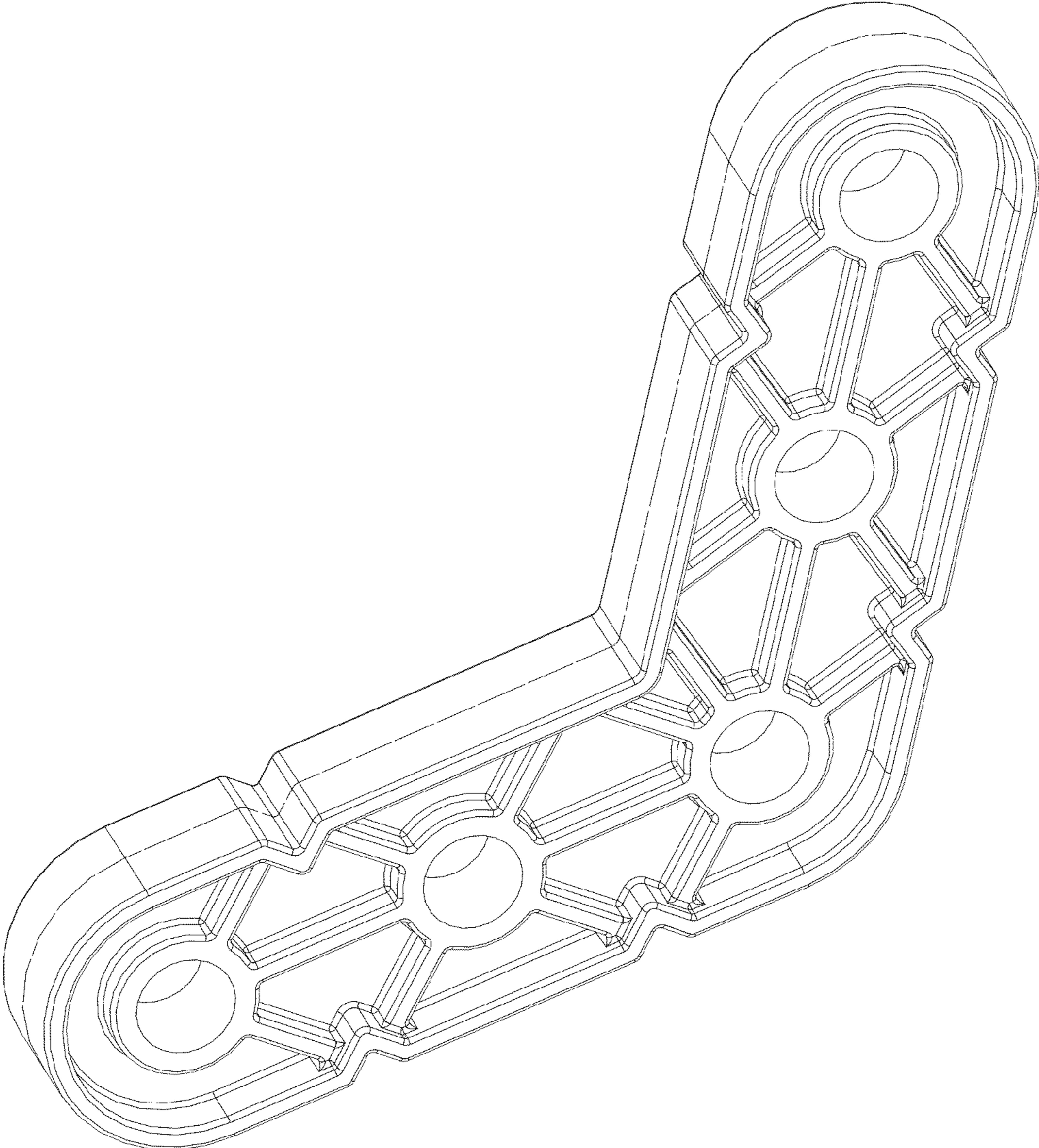

FIGURE 17

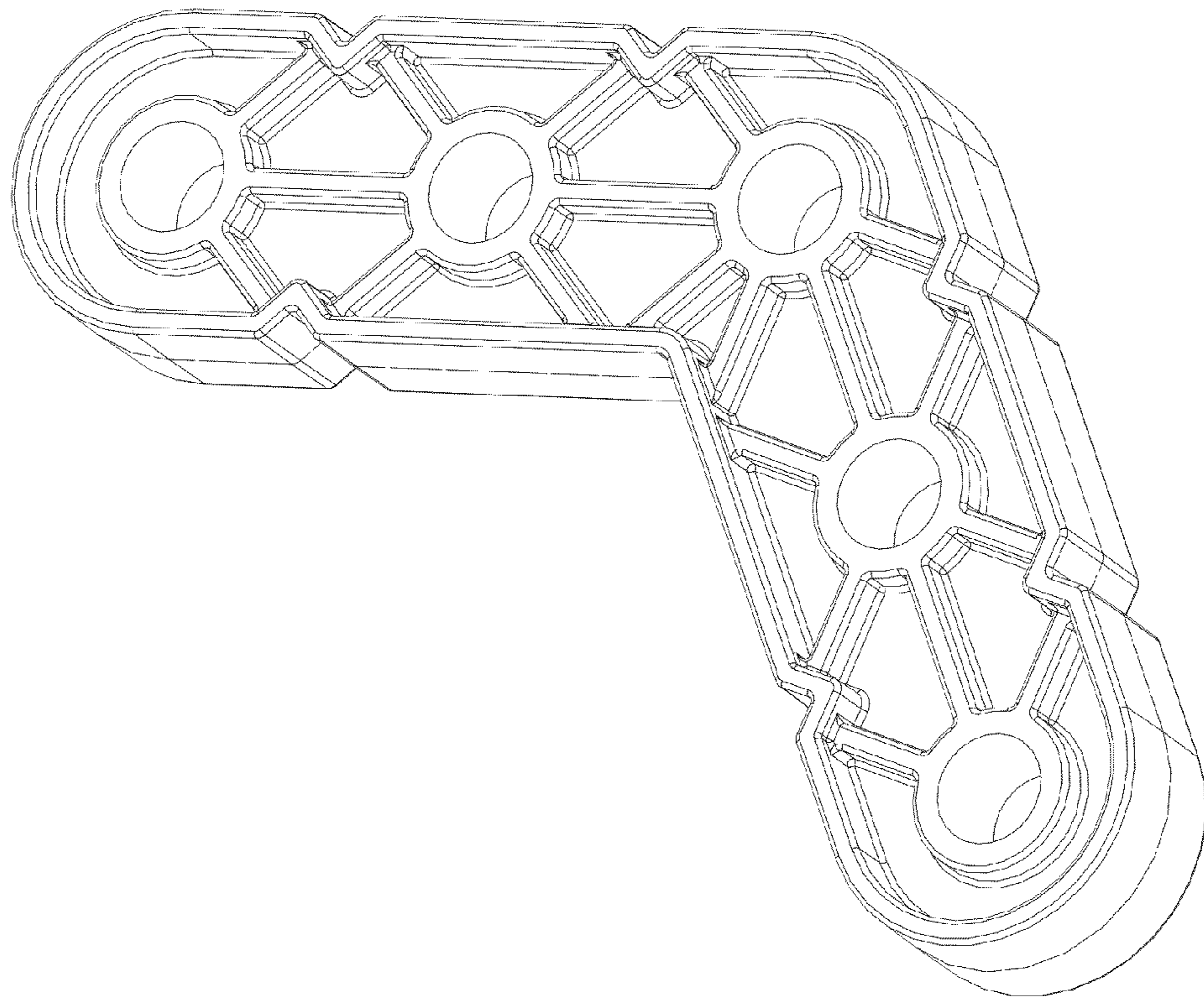

FIGURE 18

FIGURE 19

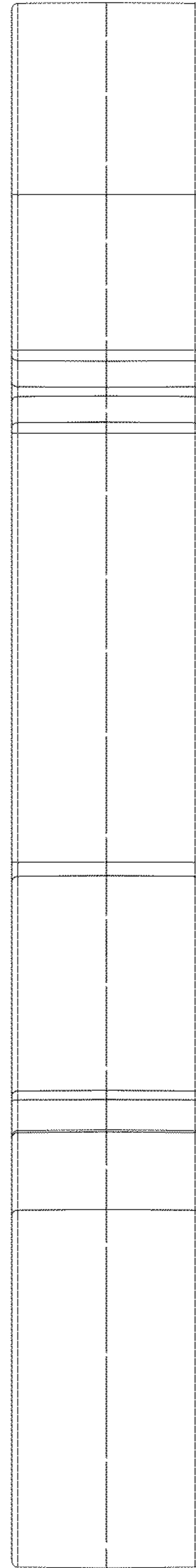
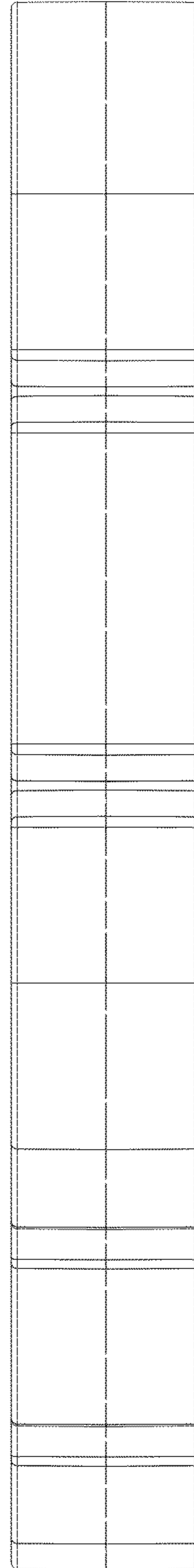

FIGURE 20



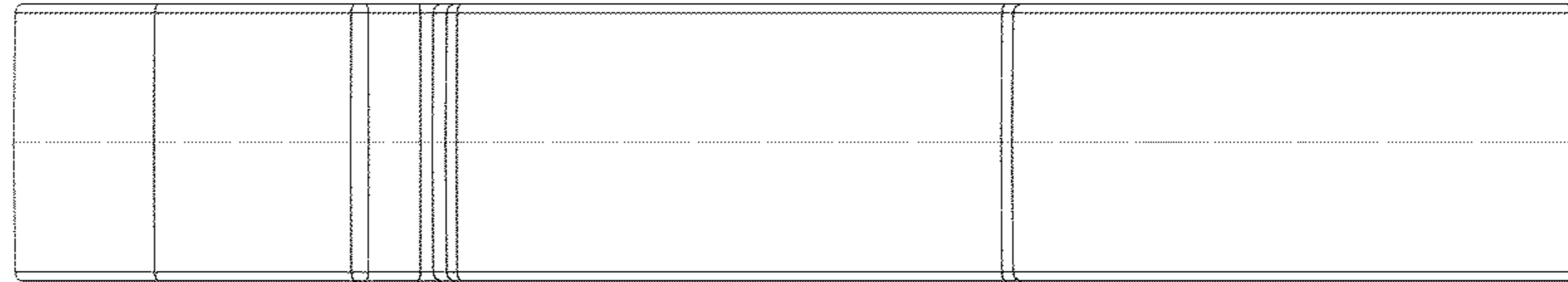

FIGURE 21

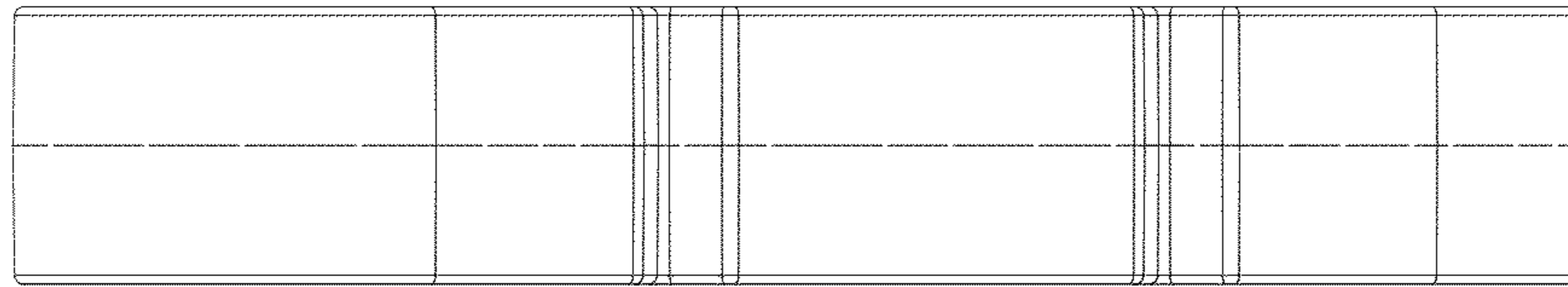

FIGURE 22

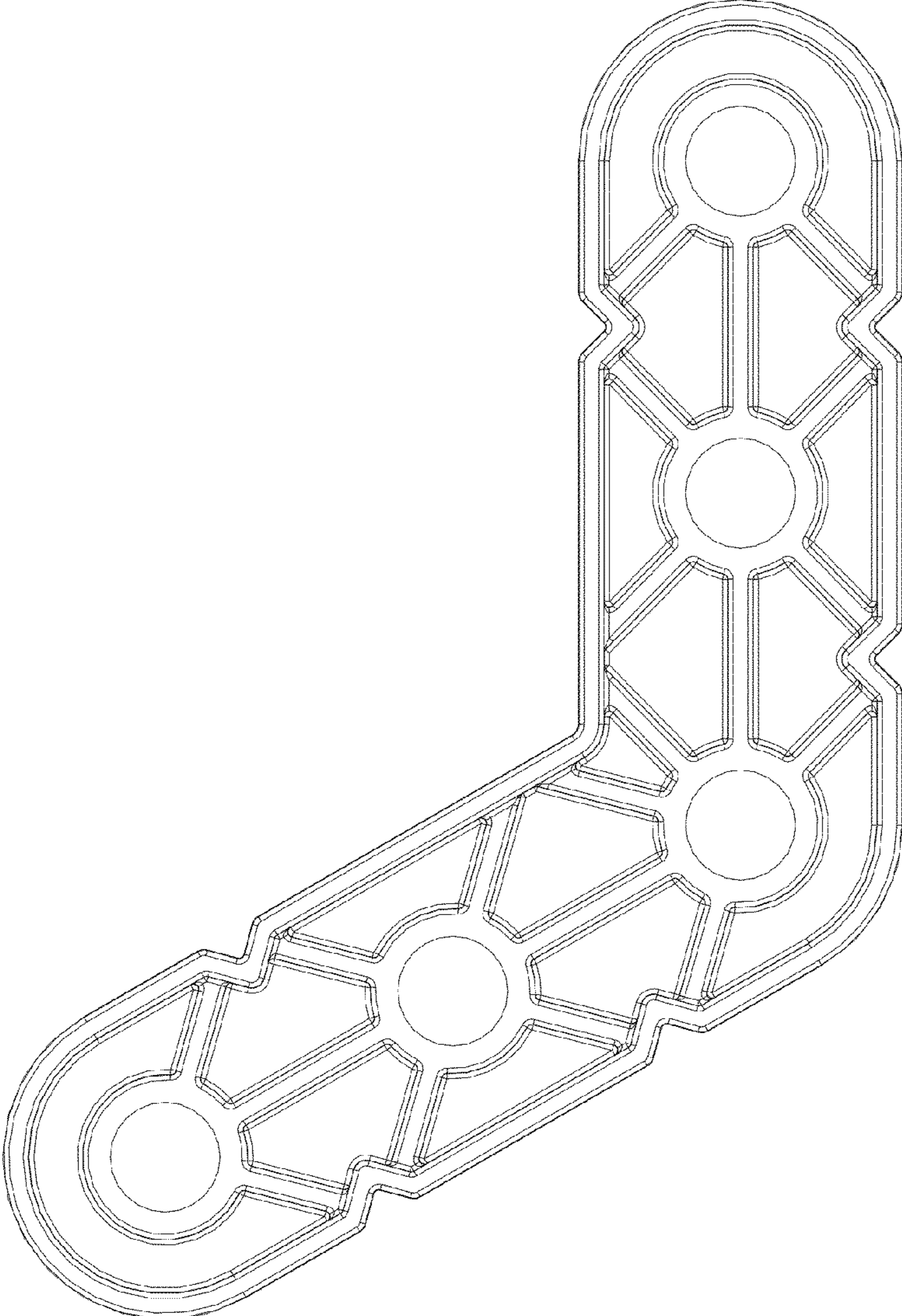

FIGURE 23

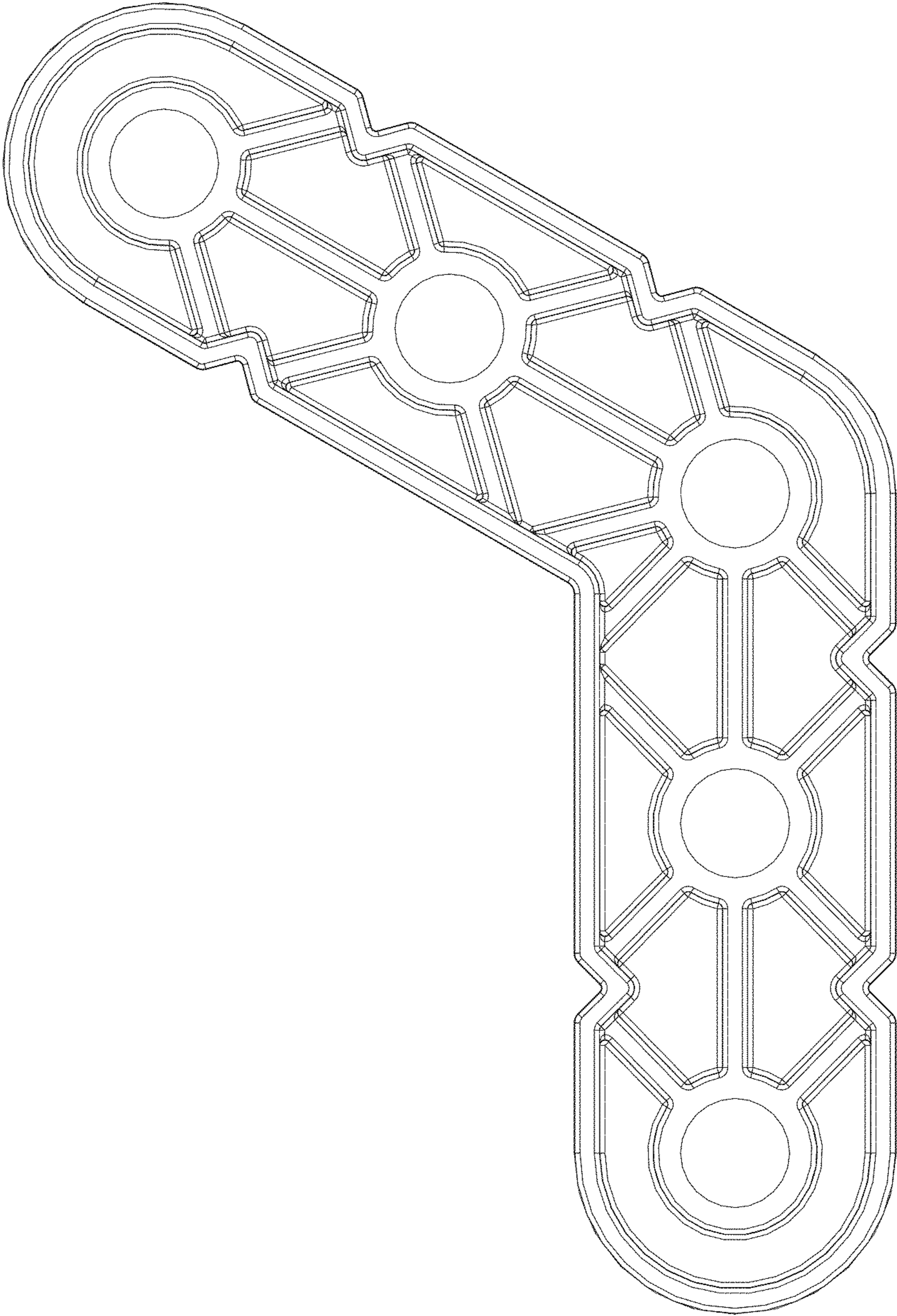

FIGURE 24