



US00D716369S

(12) **United States Design Patent**
Park et al.

(10) **Patent No.:** **US D716,369 S**

(45) **Date of Patent:** **** Oct. 28, 2014**

(54) **CARD PAYMENT TERMINAL**

(71) Applicant: **Bluebird Soft Inc.**, Seoul (KR)

(72) Inventors: **Jung Sik Park**, Namyangju-si (KR); **Ji Seok Heo**, Seoul (KR); **Jang Won Lee**, Seoul (KR)

(73) Assignee: **Bluebird Soft Inc.** (KR)

(**) Term: **14 Years**

(21) Appl. No.: **29/440,486**

(22) Filed: **Dec. 21, 2012**

(30) **Foreign Application Priority Data**

Jun. 22, 2012 (KR) 30-2012-0030713

(51) **LOC (10) Cl.** **18-01**

(52) **U.S. Cl.**
USPC **D18/4.6; D18/4.4**

(58) **Field of Classification Search**
CPC G07G 1/0027; G07G 1/12; G07G 1/0018;
G06C 7/10
USPC D14/336, 371-376, 387, 341-347;
D18/3.1-3.3, 4.1-4.6, 6-8, 11, 12,
D18/12.1-12.3; D21/324, 325, 332;
D99/28, 34-36, 43; 235/1 E, 7 R, 12,
235/22, 33, 51, 52, 2; 705/12, 15-18, 43
See application file for complete search history.

(56) **References Cited**

U.S. PATENT DOCUMENTS

D313,224 S * 12/1990 Yokoi et al. D14/346
D486,826 S * 2/2004 Janez et al. D14/387
D529,943 S * 10/2006 Chiu et al. D18/4.4
D554,694 S * 11/2007 Slinckx D18/4.4

D570,402 S * 6/2008 Henry D18/4.6
7,591,430 B2 * 9/2009 Talach et al. 235/472.01
D638,465 S * 5/2011 Goldin D18/4.6
D642,609 S * 8/2011 Goldin D18/4.4
D658,174 S * 4/2012 Tasselli et al. D14/347
D677,663 S * 3/2013 Minafo et al. D14/429

FOREIGN PATENT DOCUMENTS

JP D1475673 * 6/2013
KR 300678955.0001 * 2/2013
KR 300680469.0000 * 2/2013

* cited by examiner

Primary Examiner — Cathron Brooks
Assistant Examiner — Ethiene Salgado-Rodriguez
(74) *Attorney, Agent, or Firm* — Cantor Colburn LLP

(57) **CLAIM**

The ornamental design for a card payment terminal, as shown and described.

DESCRIPTION

FIG. 1 is a front, right and bottom side perspective view of a card payment terminal showing our new design;
FIG. 2 is a front, left and bottom side perspective view thereof;
FIG. 3 is a front elevational view thereof;
FIG. 4 is a rear elevational view thereof;
FIG. 5 is a left side elevational view thereof;
FIG. 6 is a right side elevational view thereof;
FIG. 7 is a top plan view thereof; and,
FIG. 8 is a bottom plan view thereof.
The broken lines in the drawings are included for the purpose of illustrating portions of the card payment terminal that form no part of the claimed design.
“Pidion” forming part of the claimed design is a registered trademark of BLUEBIRD INC of Seoul, Republic of Korea.

1 Claim, 8 Drawing Sheets

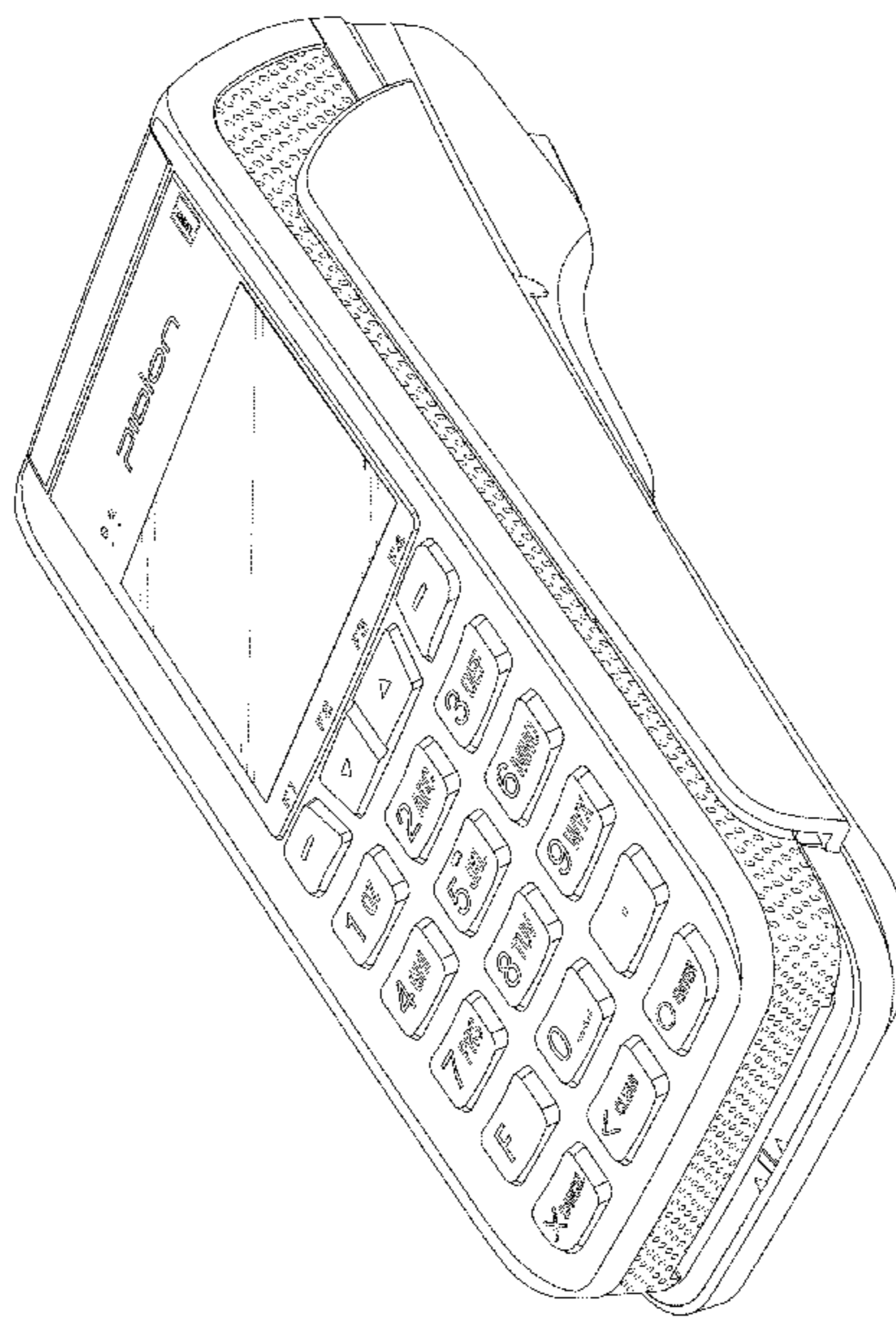

FIG. 1

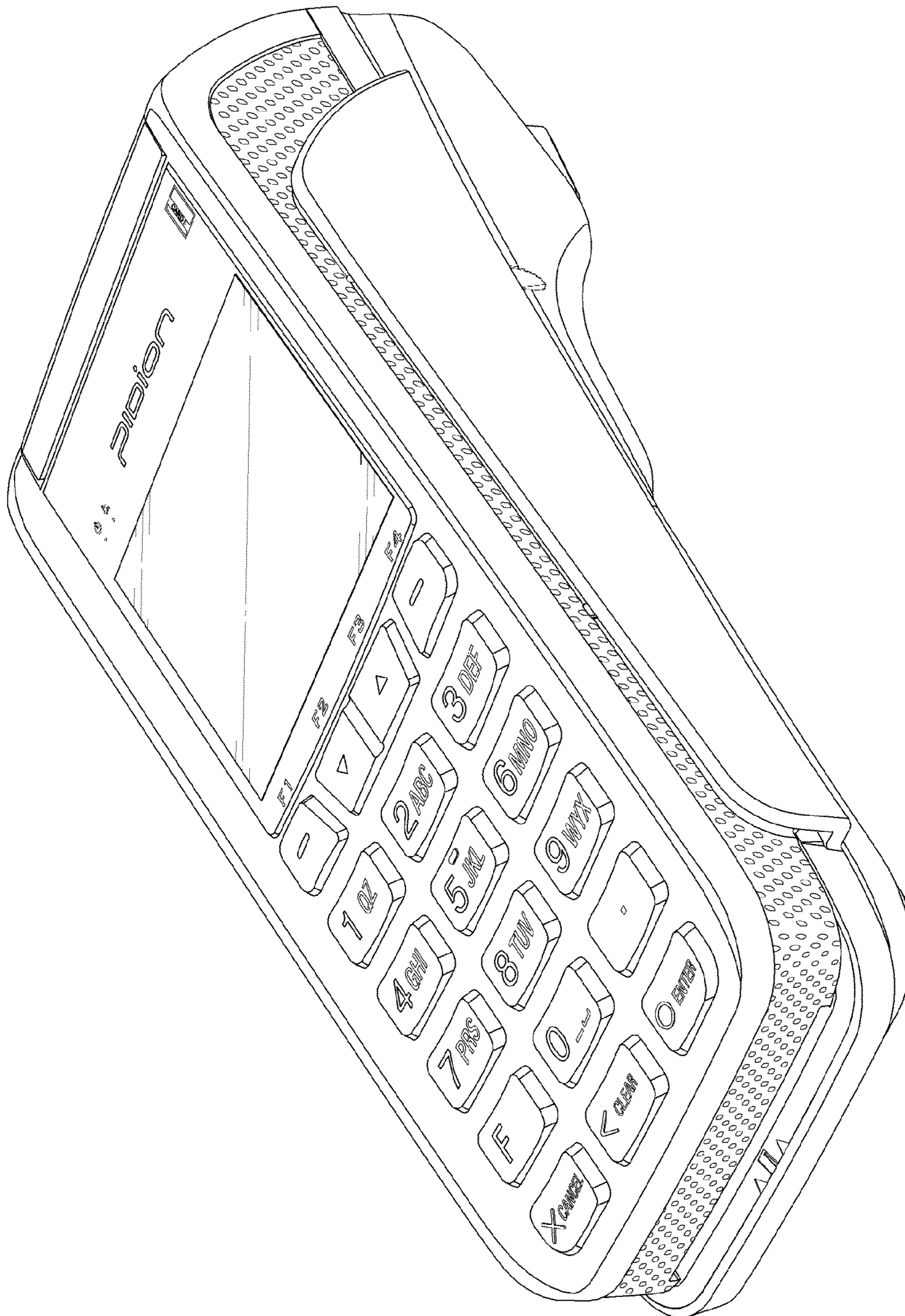

FIG. 2

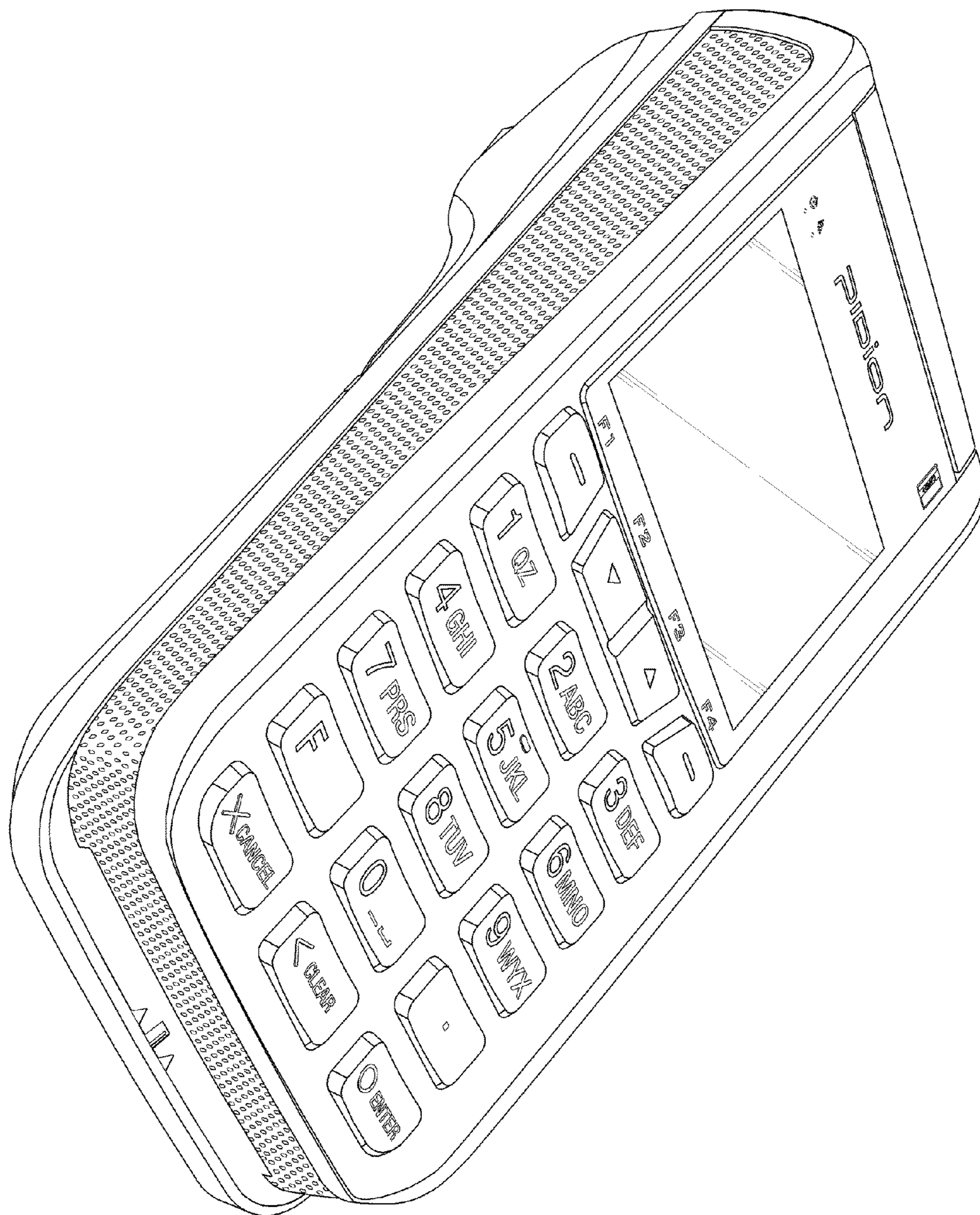

FIG. 3

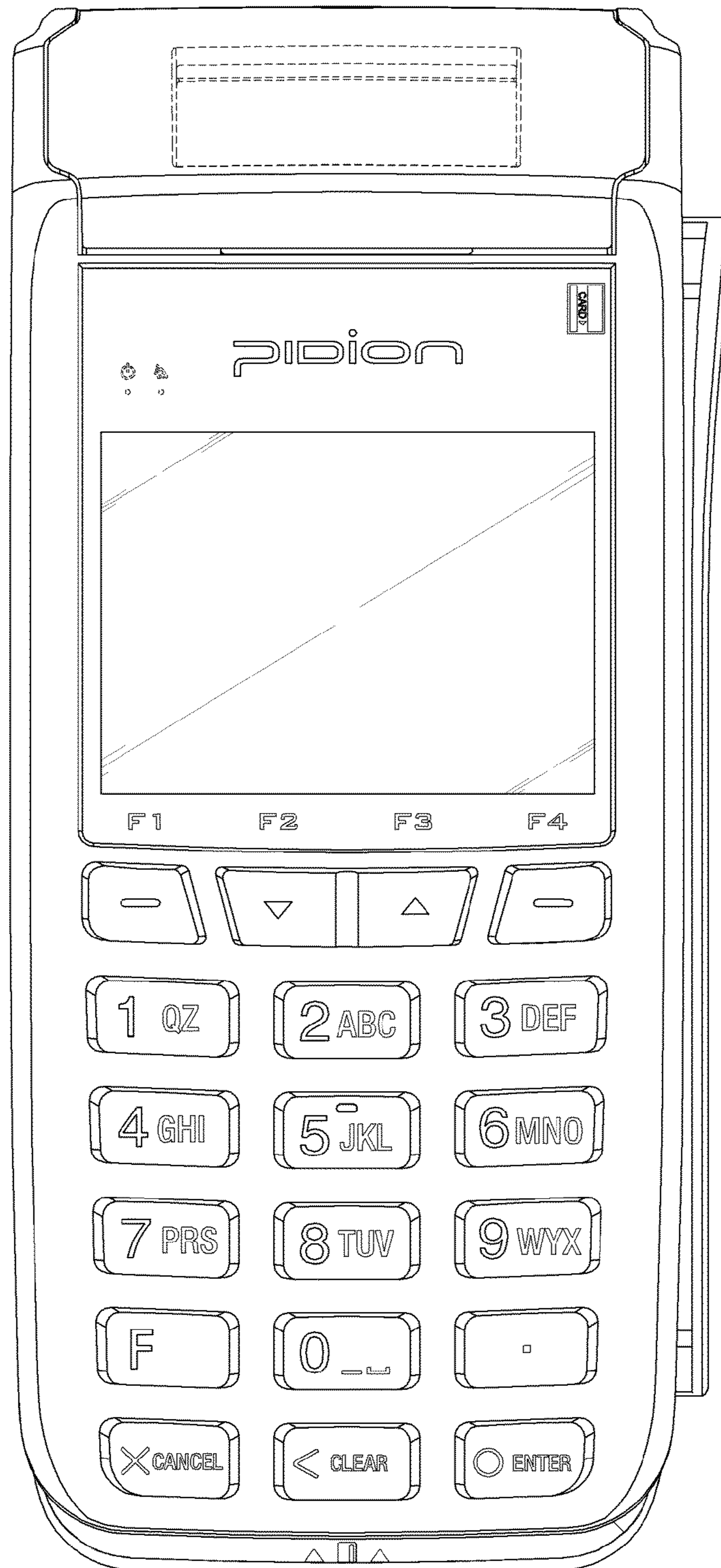

FIG. 4

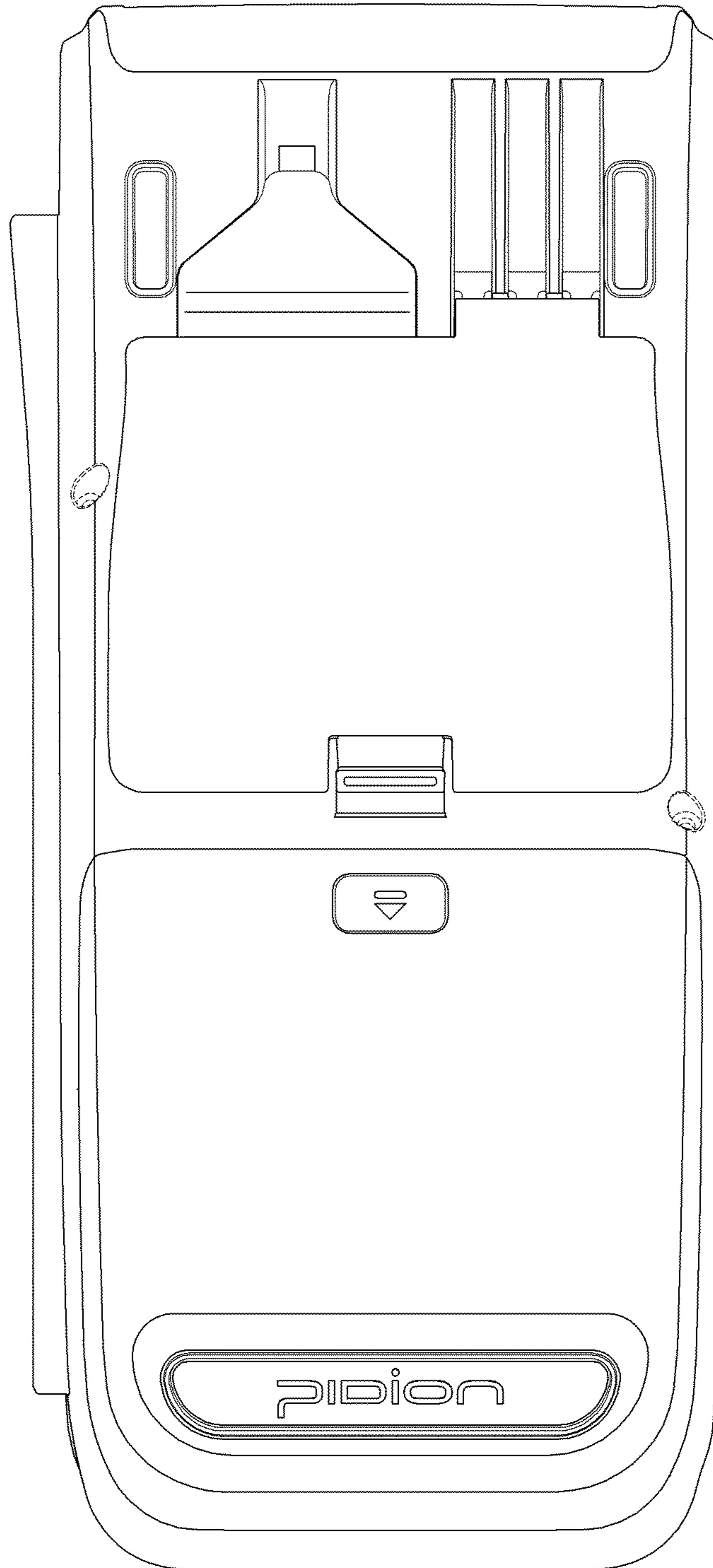

FIG. 5

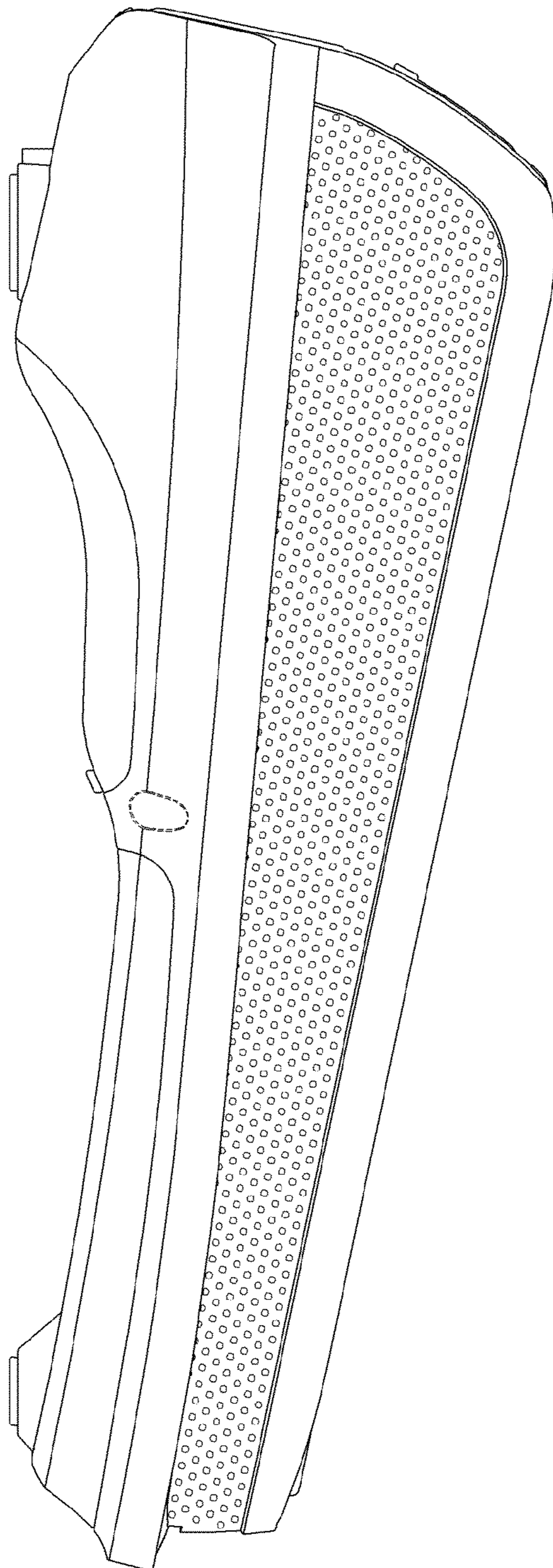

FIG. 6

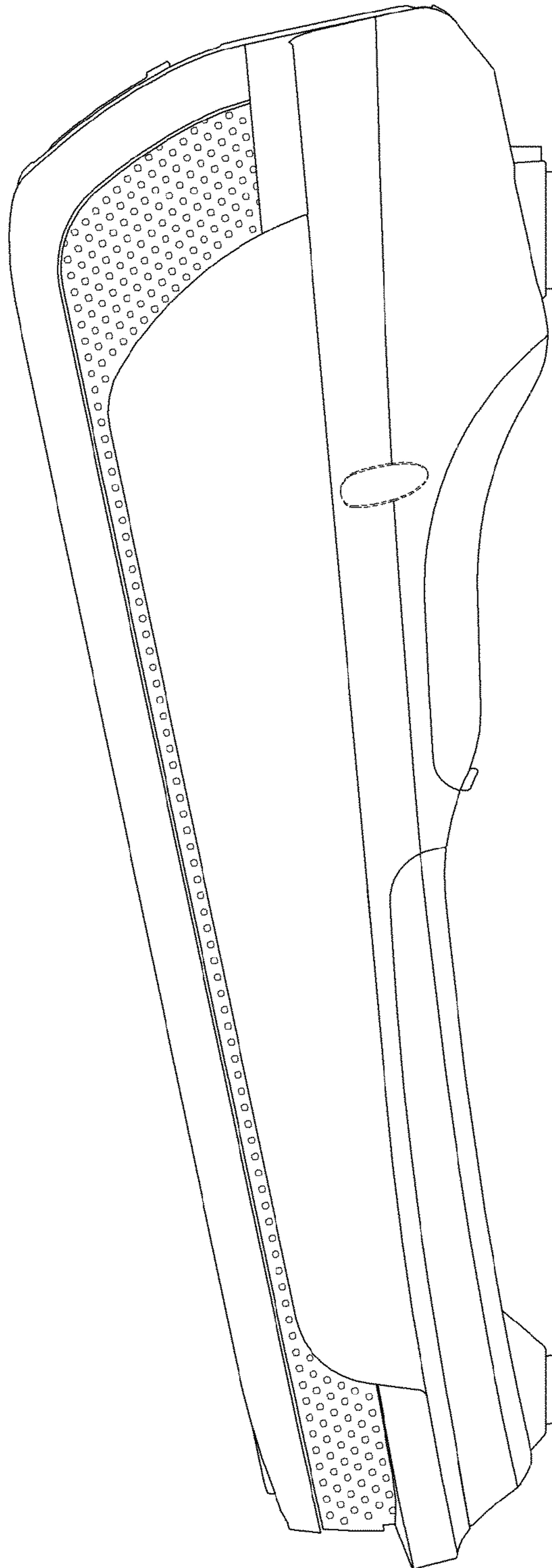

FIG. 7

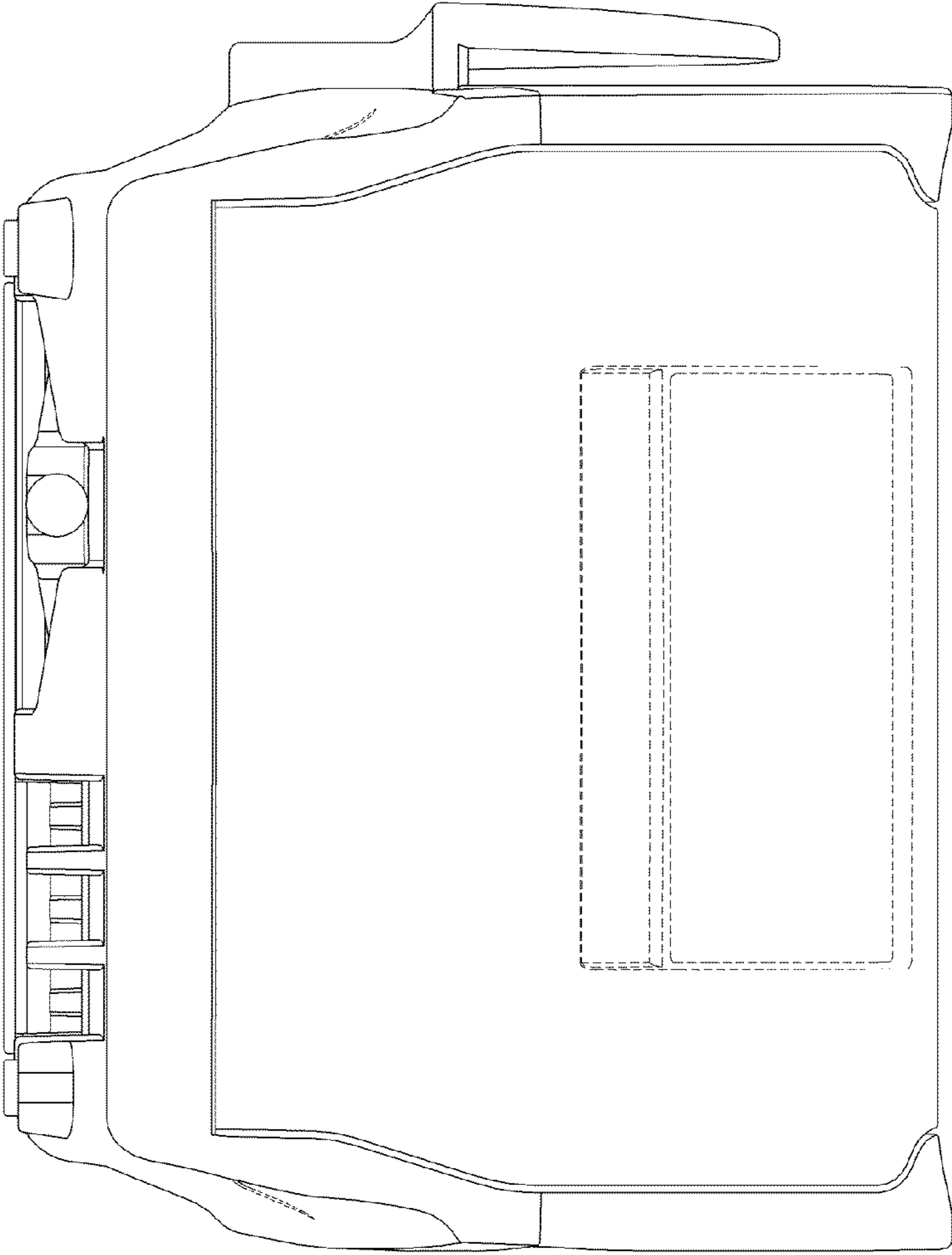

FIG. 8

