



US00D716291S

(12) **United States Design Patent**
Burris et al.

(10) **Patent No.:** **US D716,291 S**

(45) **Date of Patent:** **** Oct. 28, 2014**

(54) **TABLET**

(75) Inventors: **Joseph Burris**, Los Angeles, CA (US);
Roy Rayn, Los Angeles, CA (US)

(73) Assignee: **Shaghal Ltd.**, Los Angeles, CA (US)

(**) Term: **14 Years**

(21) Appl. No.: **29/427,371**

(22) Filed: **Jul. 17, 2012**

(51) **LOC (10) Cl.** **14-02**

(52) **U.S. Cl.**
USPC **D14/341**

(58) **Field of Classification Search**
USPC D14/341-347, 137, 138 AA, 138 R,
D14/138 C, 138 G, 496, 203.1, 203.3, 203.7,
D14/426, 129, 130, 420, 147, 218, 247-248,
D14/389, 388, 315-318; D10/65, 104.1;
D18/6-7; D21/324, 329, 330;
455/556.1, 556.2, 566, 575.1, 90.3;
379/433.04, 433.01, 433.06, 916;
345/173, 901, 905; 361/679.26,
361/679.27, 679.3, 679.55, 679.56,
361/680-686; 248/917-924; 348/373, 376;
D19/60

See application file for complete search history.

(56) **References Cited**

U.S. PATENT DOCUMENTS

D404,761 S *	1/1999	Tarpenning et al.	D14/341
D425,558 S *	5/2000	Tarpenning et al.	D19/26
D483,361 S *	12/2003	Yao et al.	D14/374
D493,787 S *	8/2004	Avery	D14/345
D594,453 S *	6/2009	Miyawaki	D14/341
D595,291 S *	6/2009	Takemasa	D14/346
D692,881 S *	11/2013	Akana et al.	D14/341

* cited by examiner

Primary Examiner — Barbara Fox

(74) *Attorney, Agent, or Firm* — Thomas I. Rozsa

(57) **CLAIM**

The ornamental design for a tablet, as shown and described.

DESCRIPTION

FIG. 1 is a front right bottom perspective view of a tablet, showing our design;
FIG. 2 is a front right top perspective view thereof;
FIG. 3 is a rear left bottom perspective view thereof;
FIG. 4 is a front view thereof;
FIG. 5 is a rear view thereof;
FIG. 6 is a top view thereof;
FIG. 7 is a bottom view thereof;
FIG. 8 is a right side view thereof; and,
FIG. 9 is a left side view thereof.

1 Claim, 6 Drawing Sheets

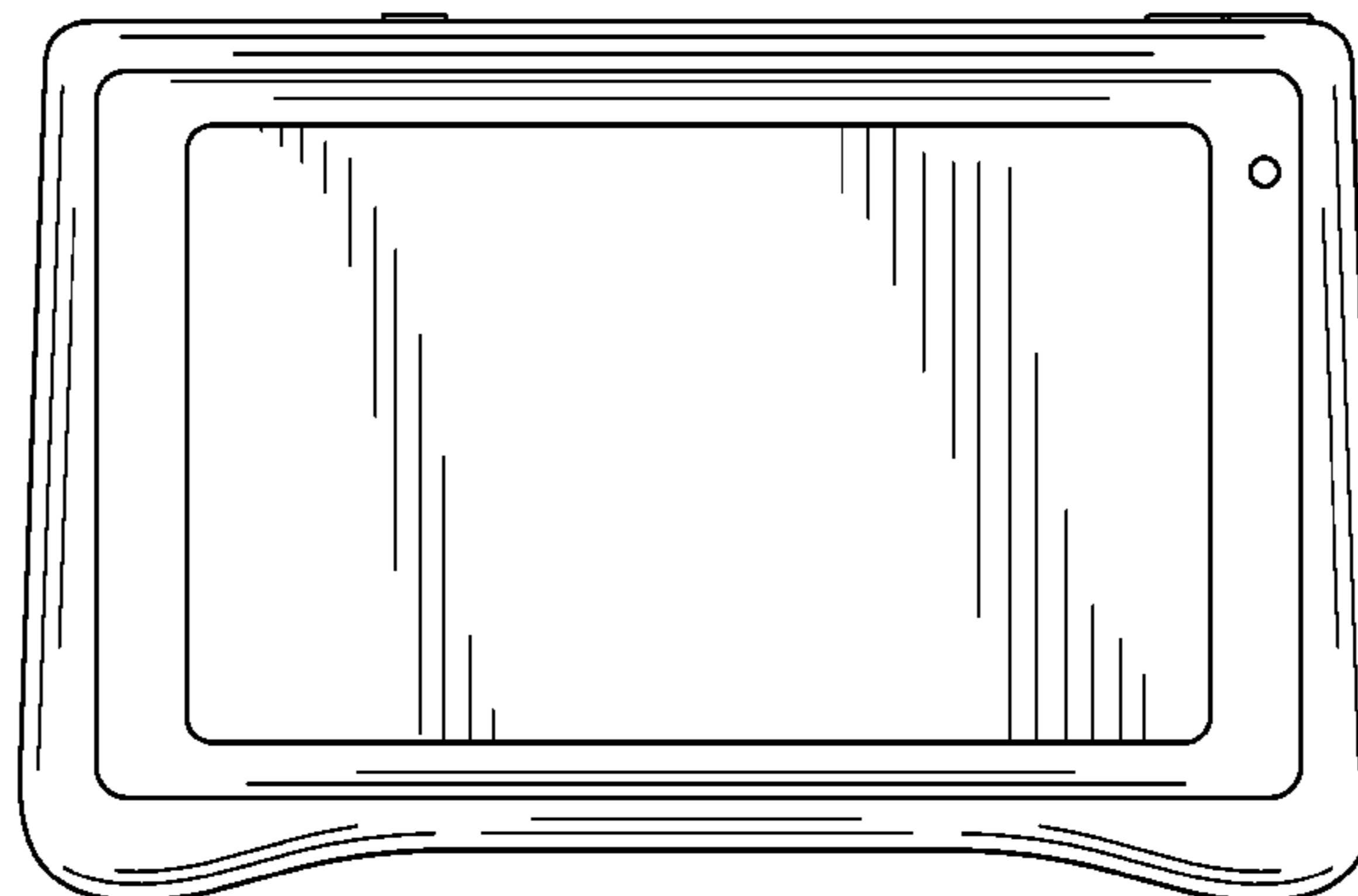
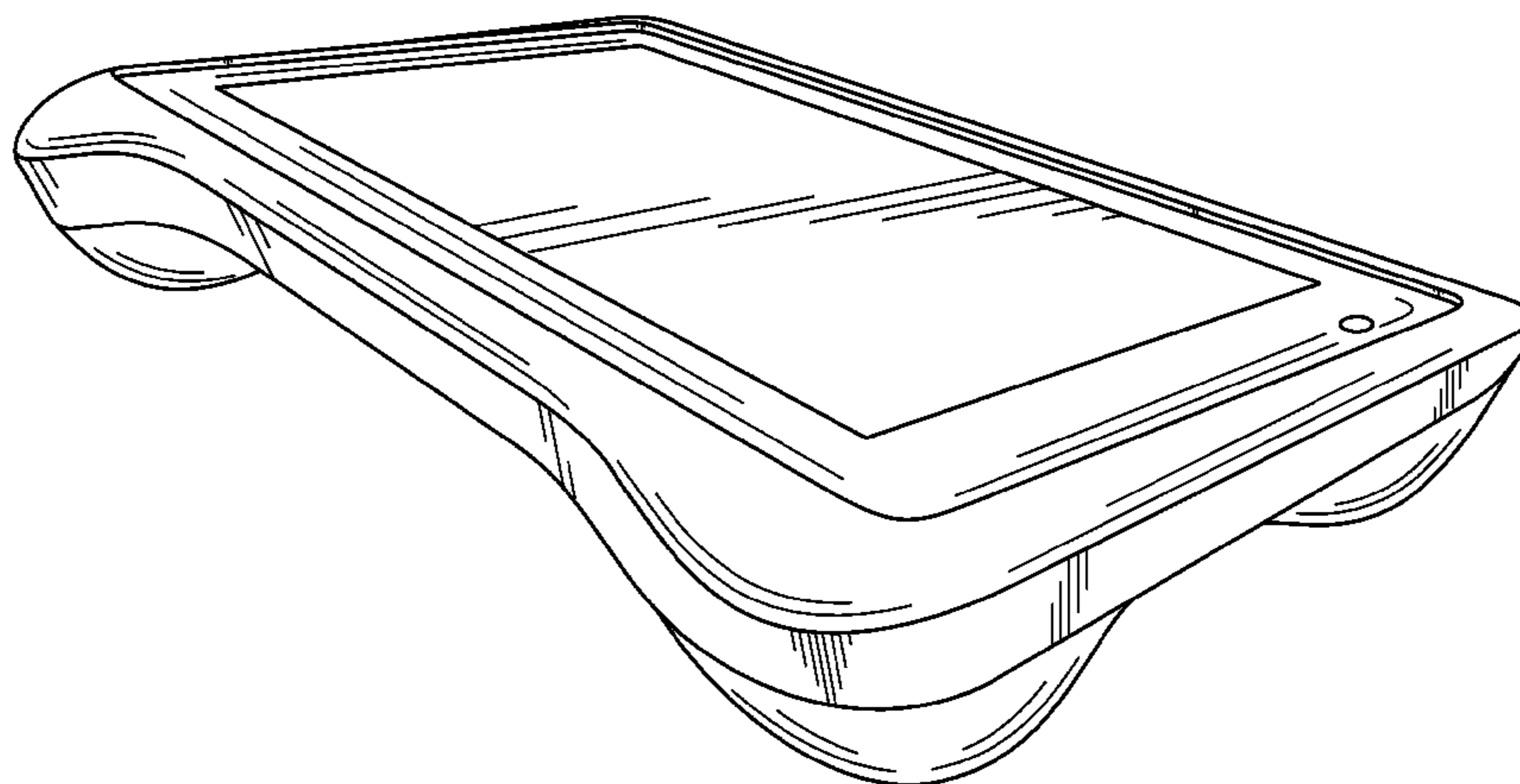

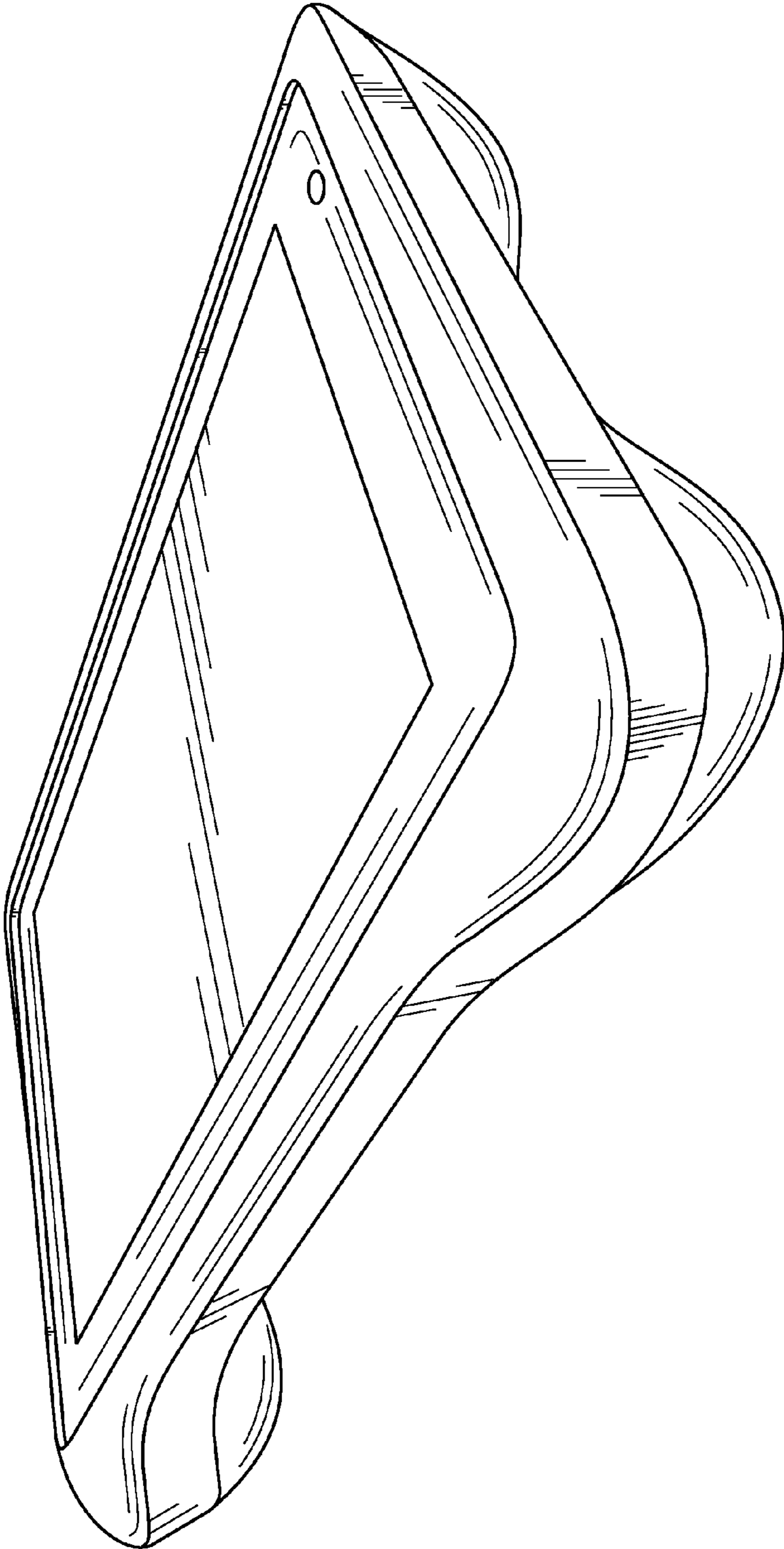

FIG. 1

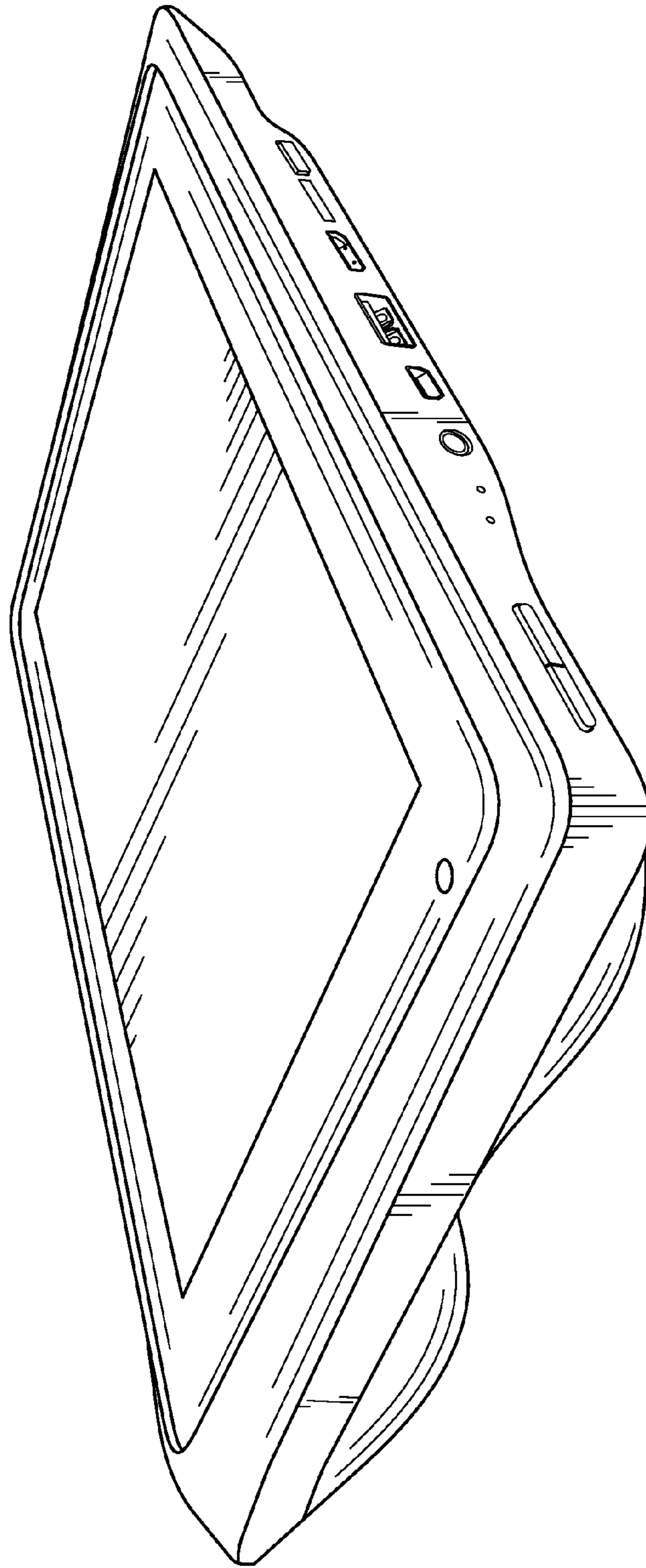

FIG. 2

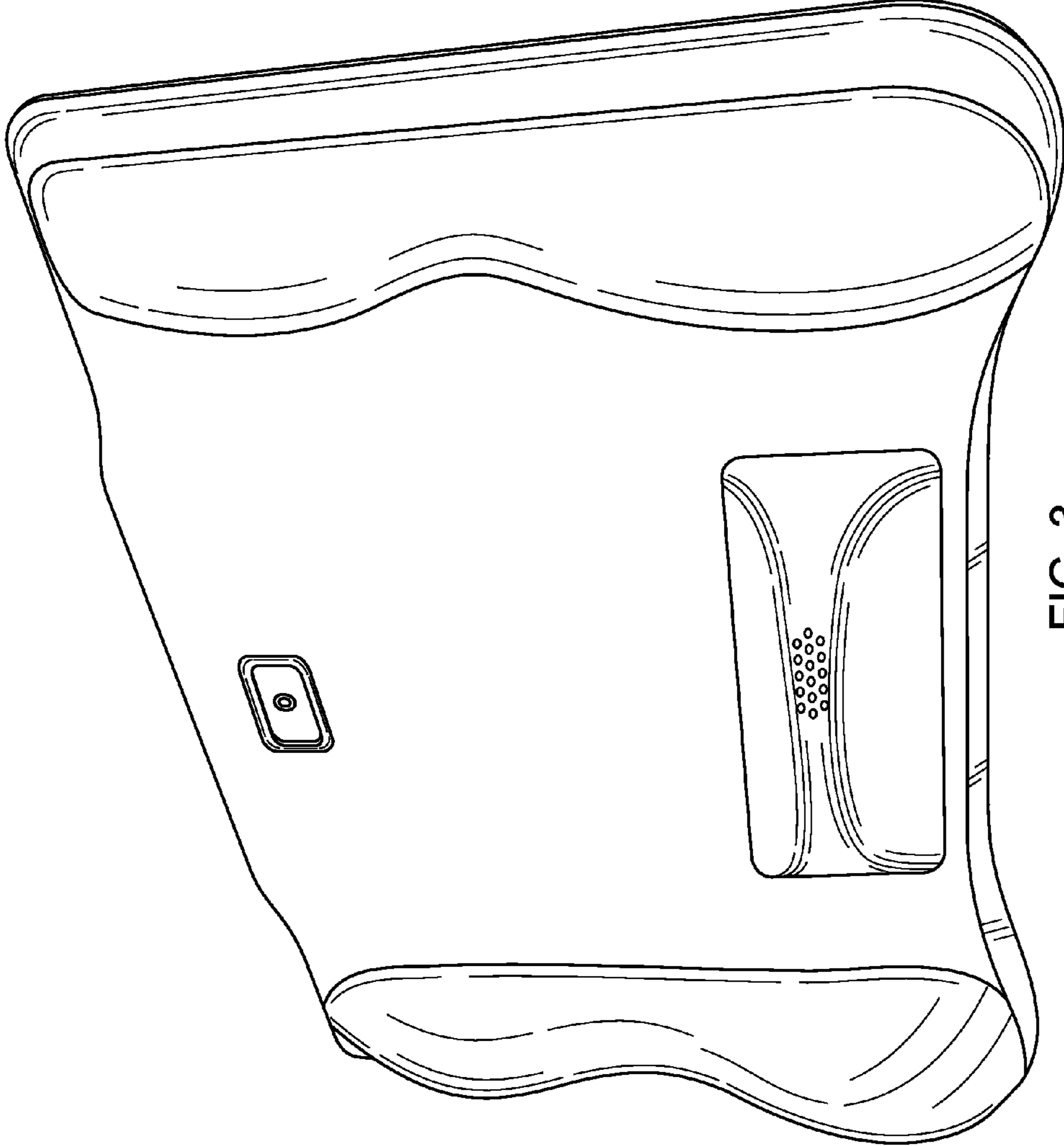

FIG. 3

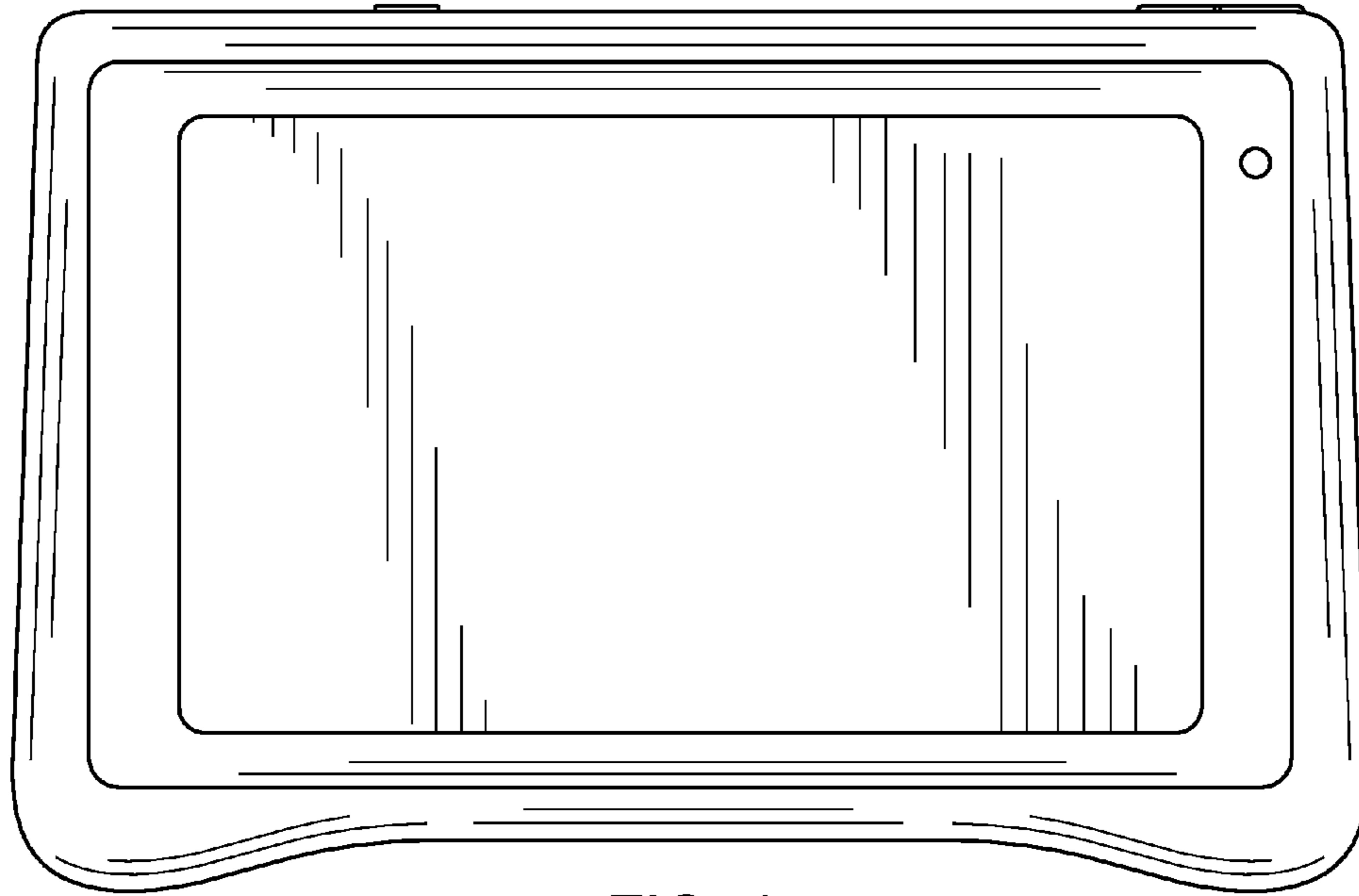

FIG. 4

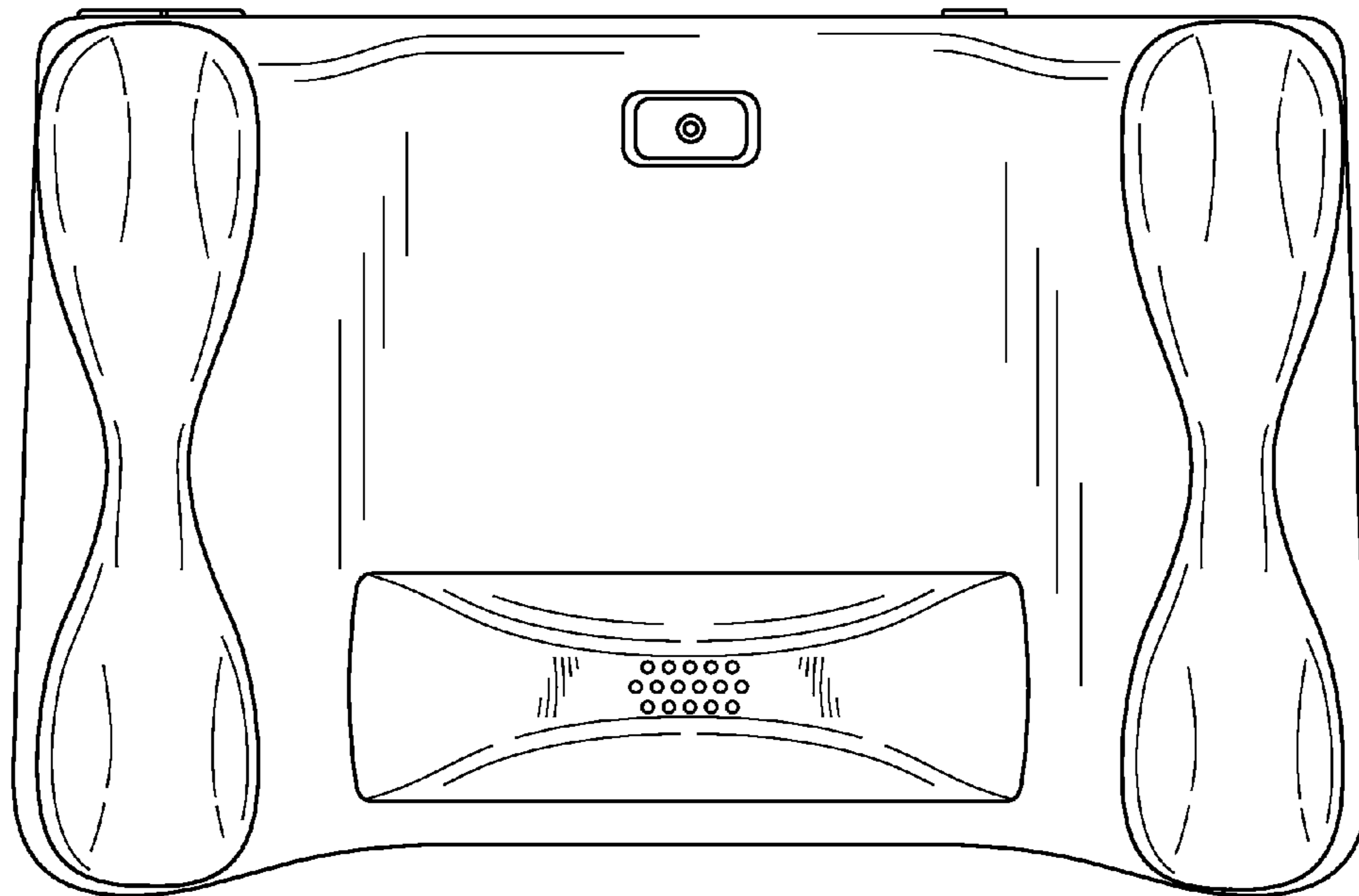

FIG. 5

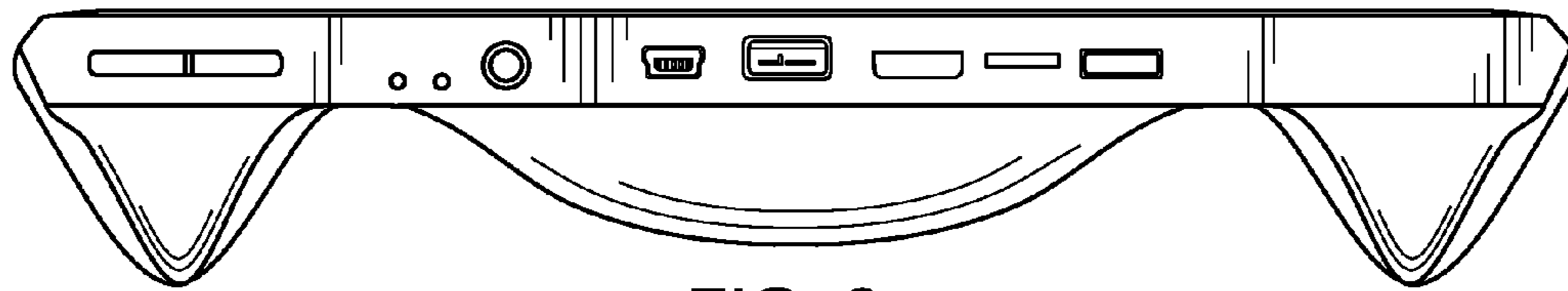

FIG. 6

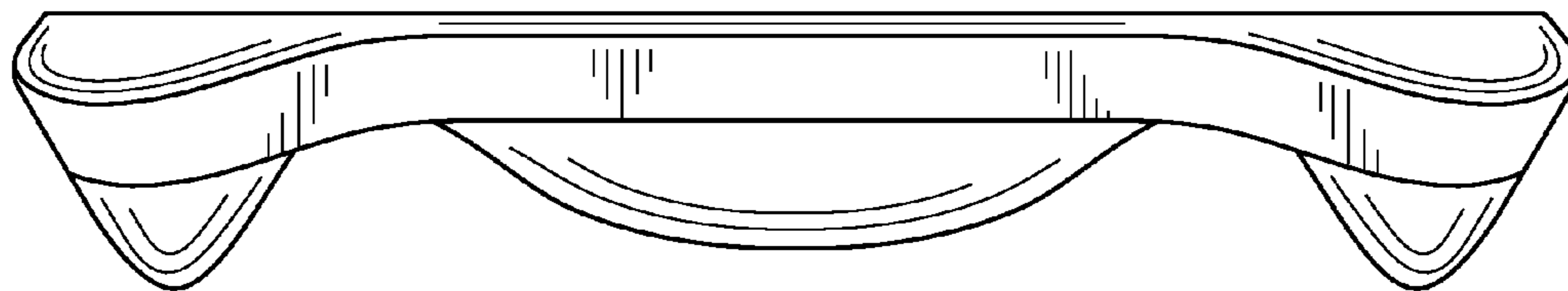

FIG. 7

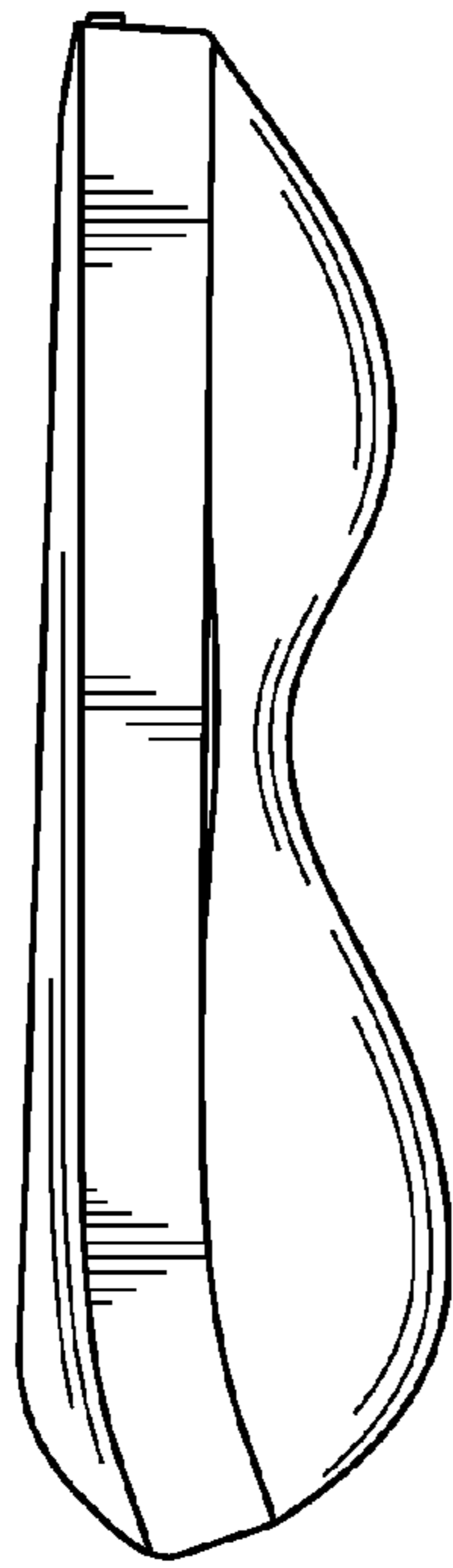

FIG. 8

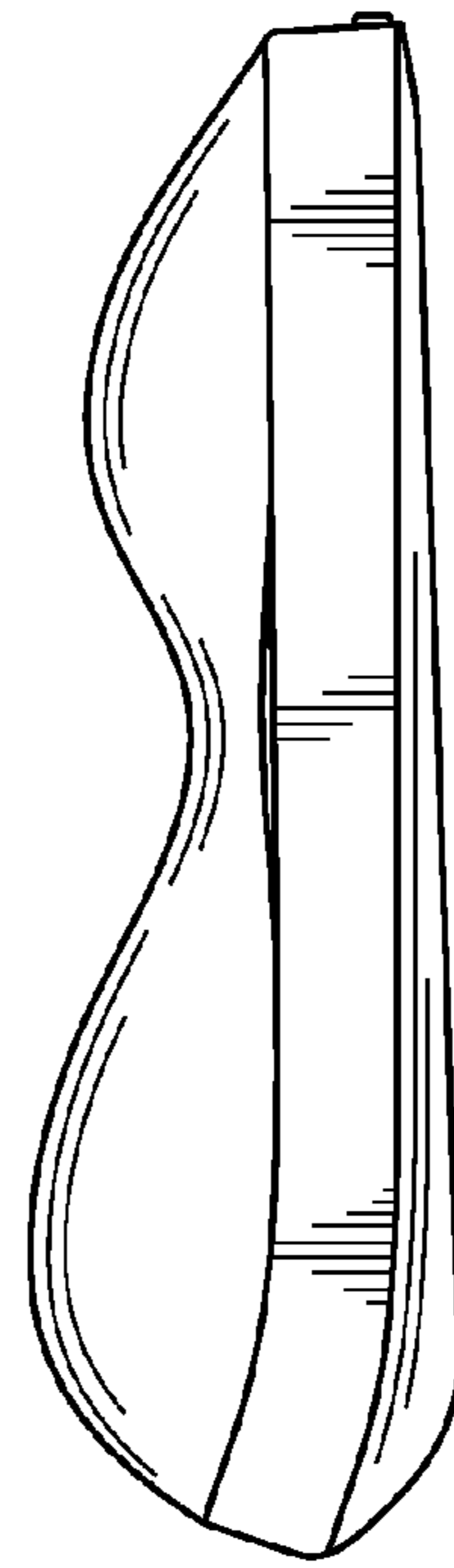

FIG. 9