



US00D716141S

(12) **United States Design Patent**  
**Rush**

(10) **Patent No.:** **US D716,141 S**

(45) **Date of Patent:** **\*\* Oct. 28, 2014**

(54) **CUP LID**

(75) Inventor: **Jonathan E. Rush**, Mount Bethel, PA (US)

(73) Assignee: **Dixie Consumer Products LLC**, Atlanta, GA (US)

(\*\*) Term: **14 Years**

(21) Appl. No.: **29/425,353**

(22) Filed: **Jun. 21, 2012**

(51) **LOC (10) Cl.** ..... **09-07**

(52) **U.S. Cl.**  
USPC ..... **D9/447**

(58) **Field of Classification Search**

USPC ..... D7/300, 300.1, 321, 396.2, 500, 507, D7/509, 510, 511; D9/434, 435, 443, 444, D9/445, 447, 452, 455; 215/200, 235, 236, 215/252, 254, 329, 355-364; 220/203.04-203.07, 220, 254.1, 254.4, 220/703, 704, 705

See application file for complete search history.

(56) **References Cited**

**U.S. PATENT DOCUMENTS**

D287,919 S \* 1/1987 Clements ..... D7/392.1  
D379,928 S \* 6/1997 Freck et al. .... D9/447

(Continued)

**FOREIGN PATENT DOCUMENTS**

CA 2584589 A1 10/2007

*Primary Examiner* — Robert M Spear

*Assistant Examiner* — Marissa Cash

(74) *Attorney, Agent, or Firm* — William W. Letson

(57) **CLAIM**

The ornamental design for a cup lid, as shown and described.

**DESCRIPTION**

FIG. 1 is a perspective view of a first embodiment of a cup lid; FIG. 2 is a top plan view of the cup lid of FIG. 1; FIG. 3 is a bottom plan view of the cup lid of FIG. 1; FIG. 4 is a front view of the cup lid of FIG. 1; FIG. 5 is a back view of the cup lid of FIG. 1; FIG. 6 is a right side view of the cup lid of FIG. 1; FIG. 7 is a left side view of the cup lid of FIG. 1; FIG. 8 is a perspective view of a second embodiment of the cup lid; FIG. 9 is a top plan view of the cup lid of FIG. 8; FIG. 10 is a bottom plan view of the cup lid of FIG. 8; FIG. 11 is a front view of the cup lid of FIG. 8; FIG. 12 is a back view of the cup lid of FIG. 8; FIG. 13 is a right side view of the cup lid of FIG. 8; FIG. 14 is a left side view of the cup lid of FIG. 8; FIG. 15 is a perspective view of a third embodiment of the cup lid; FIG. 16 is a top plan view of the cup lid of FIG. 15; FIG. 17 is a bottom plan view of the cup lid of FIG. 15; FIG. 18 is a front view of the cup lid of FIG. 15; FIG. 19 is a right side view of the cup lid of FIG. 15; FIG. 20 is a left side view of the cup lid of FIG. 15; and, FIG. 21 is a back view of the cup lid of FIG. 15. In the drawings, the broken lines depict unclaimed environmental subject matter only and form no part of the claimed design.

**1 Claim, 14 Drawing Sheets**

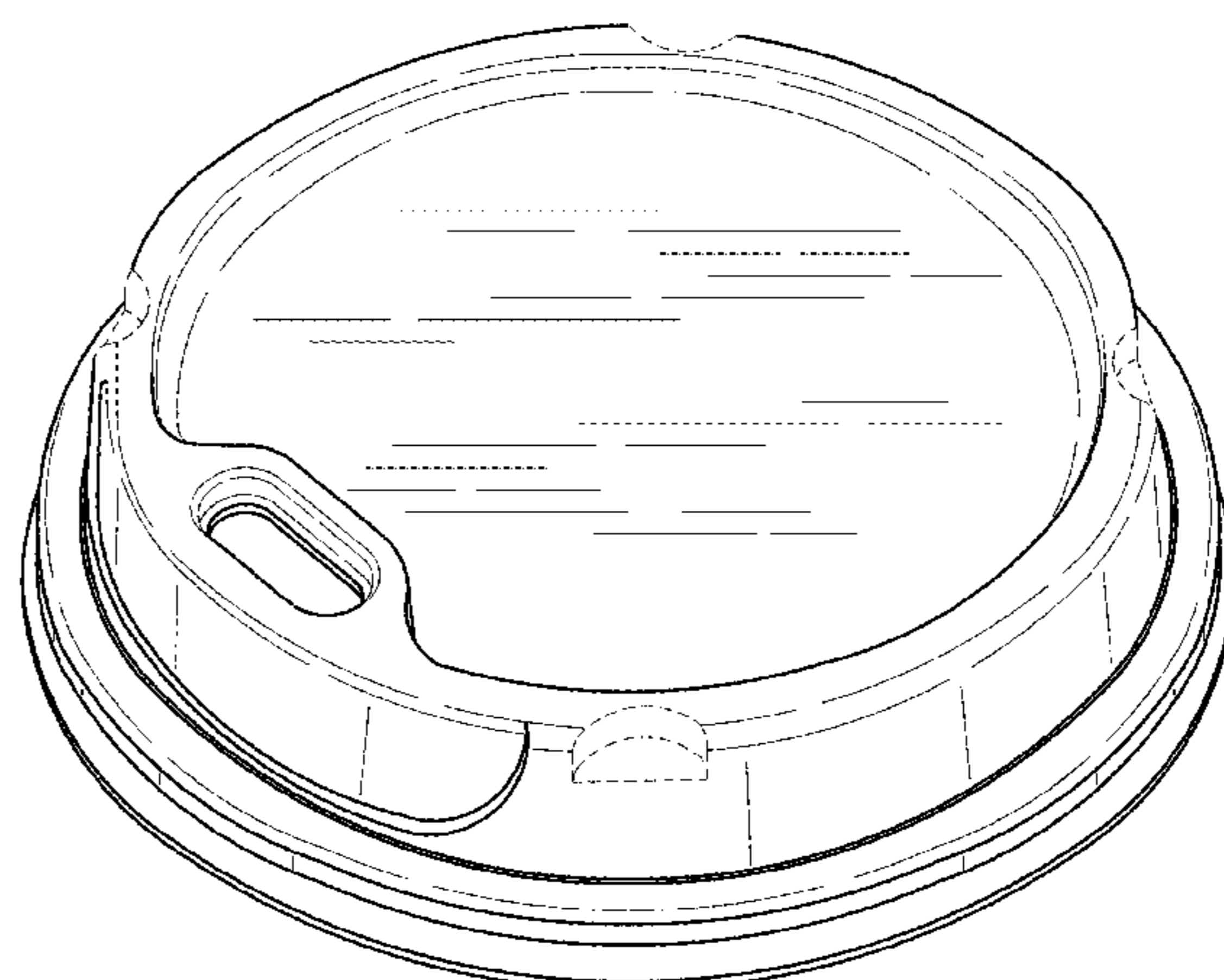
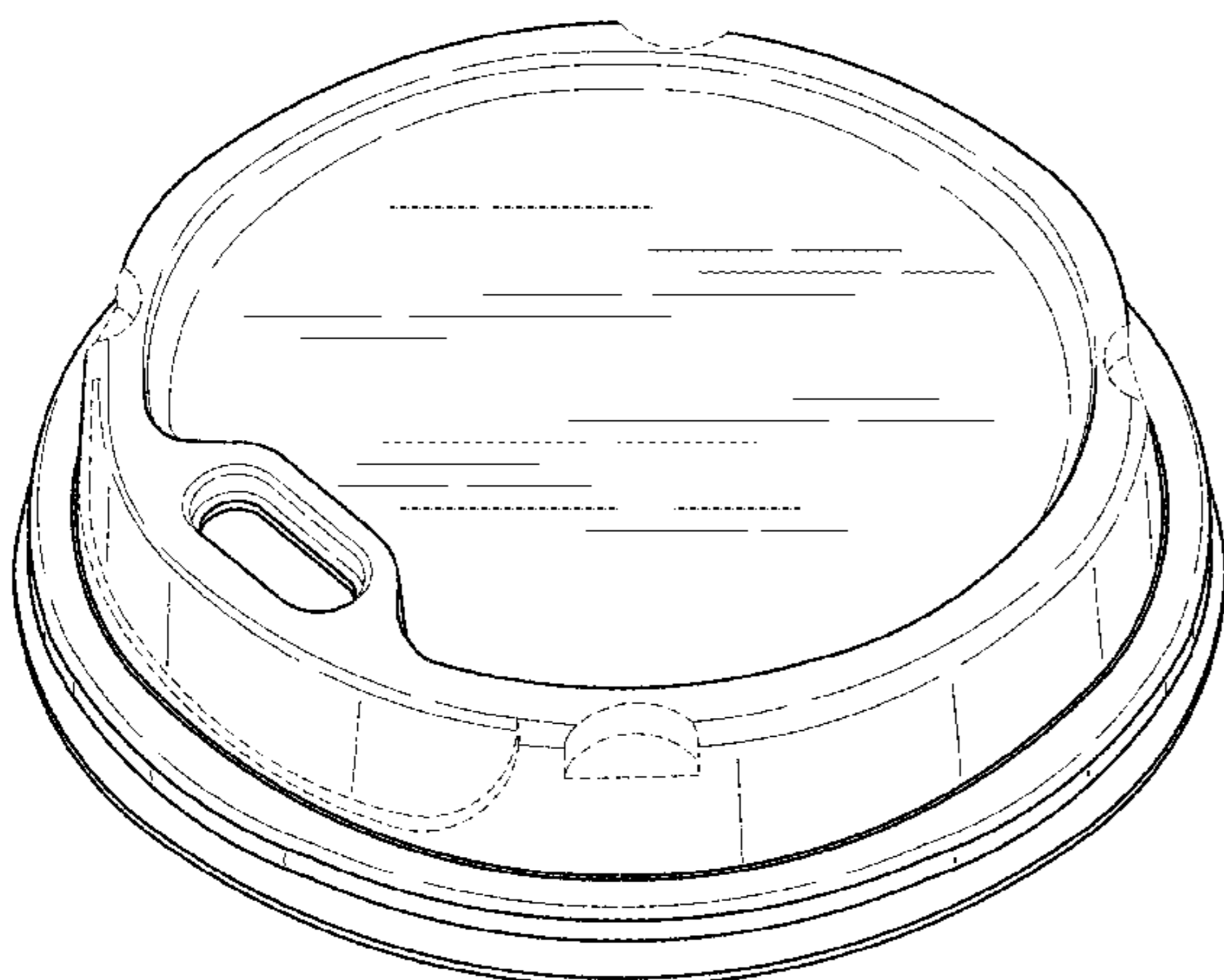

(56)

**References Cited**

U.S. PATENT DOCUMENTS

D402,556 S	12/1998	Frye			
D417,845 S	12/1999	Sadlier et al.			
D489,260 S	5/2004	Smith et al.			
6,732,875 B2	5/2004	Smith et al.			
D516,424 S	3/2006	Schweigert			
D531,033 S	10/2006	Schmidtner et al.			
D533,779 S	12/2006	Schmidtner et al.			
7,156,251 B2	1/2007	Smith et al.			
7,159,732 B2	1/2007	Smith et al.			
7,246,715 B2	7/2007	Smith et al.			
D591,595 S *	5/2009	Tedford, Jr. ....	D9/447		
					* cited by examiner
		D592,056 S *	5/2009	Tedford, Jr. ....	D9/447
		7,845,510 B2	12/2010	Schmidtner et al.	
		7,850,037 B2	12/2010	Schmidtner et al.	
		7,874,447 B2	1/2011	Schmidtner et al.	
		D635,855 S *	4/2011	Smith et al. ....	D9/447
		D658,057 S *	4/2012	Donat .....	D9/447
		D675,524 S *	2/2013	Bickert et al. ....	D9/447
		D696,940 S *	1/2014	Hale et al. ....	D9/447
		D696,942 S *	1/2014	Kim .....	D9/447
		2003/0197012 A1 *	10/2003	Smith et al. ....	220/253
		2005/0173434 A1 *	8/2005	O'Neal .....	220/212
		2006/0000832 A1	1/2006	Smith et al.	
		2006/0071008 A1 *	4/2006	Sadlier .....	220/713
		2006/0243734 A1	11/2006	Tedford, Jr.	

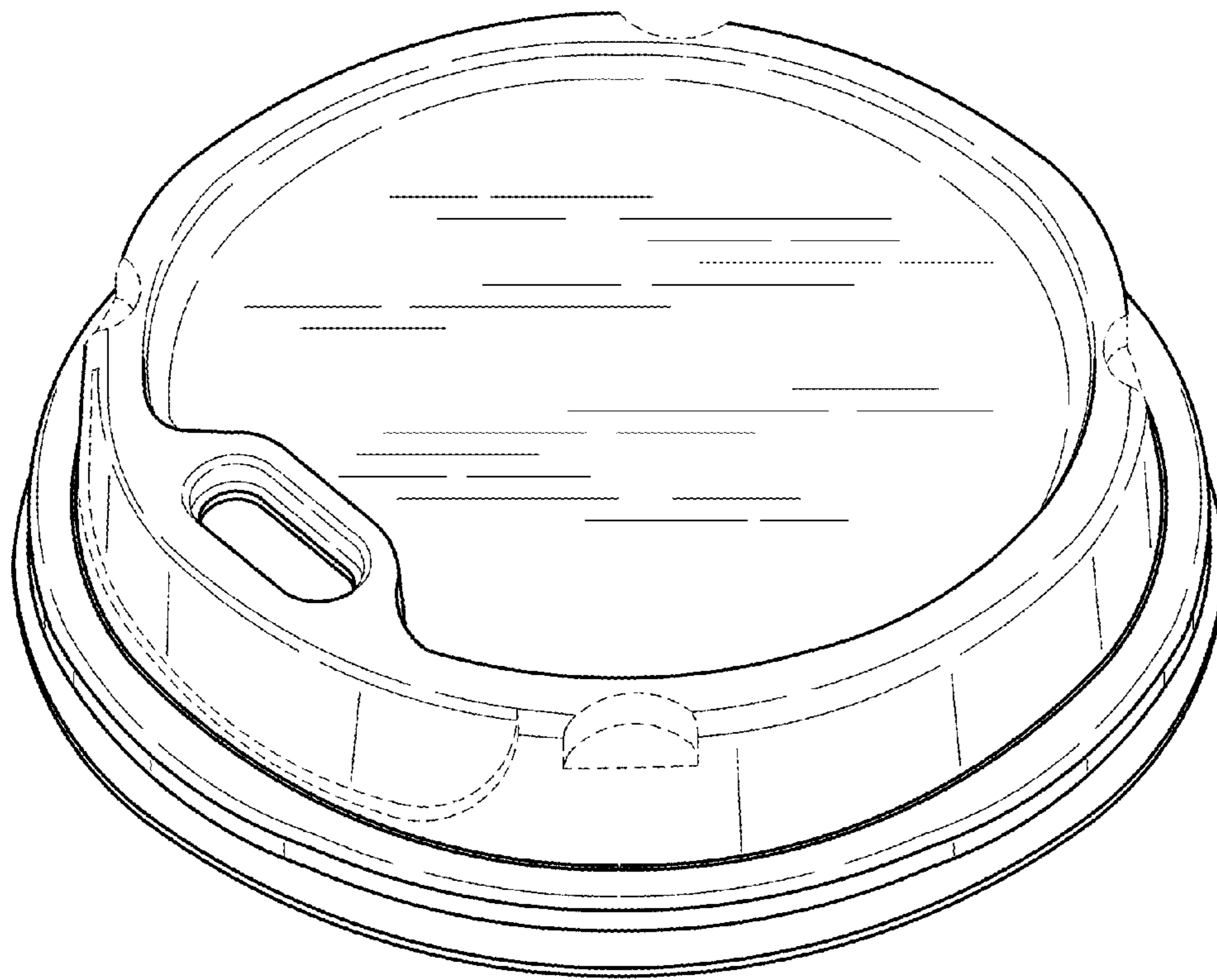

*Fig. 1*

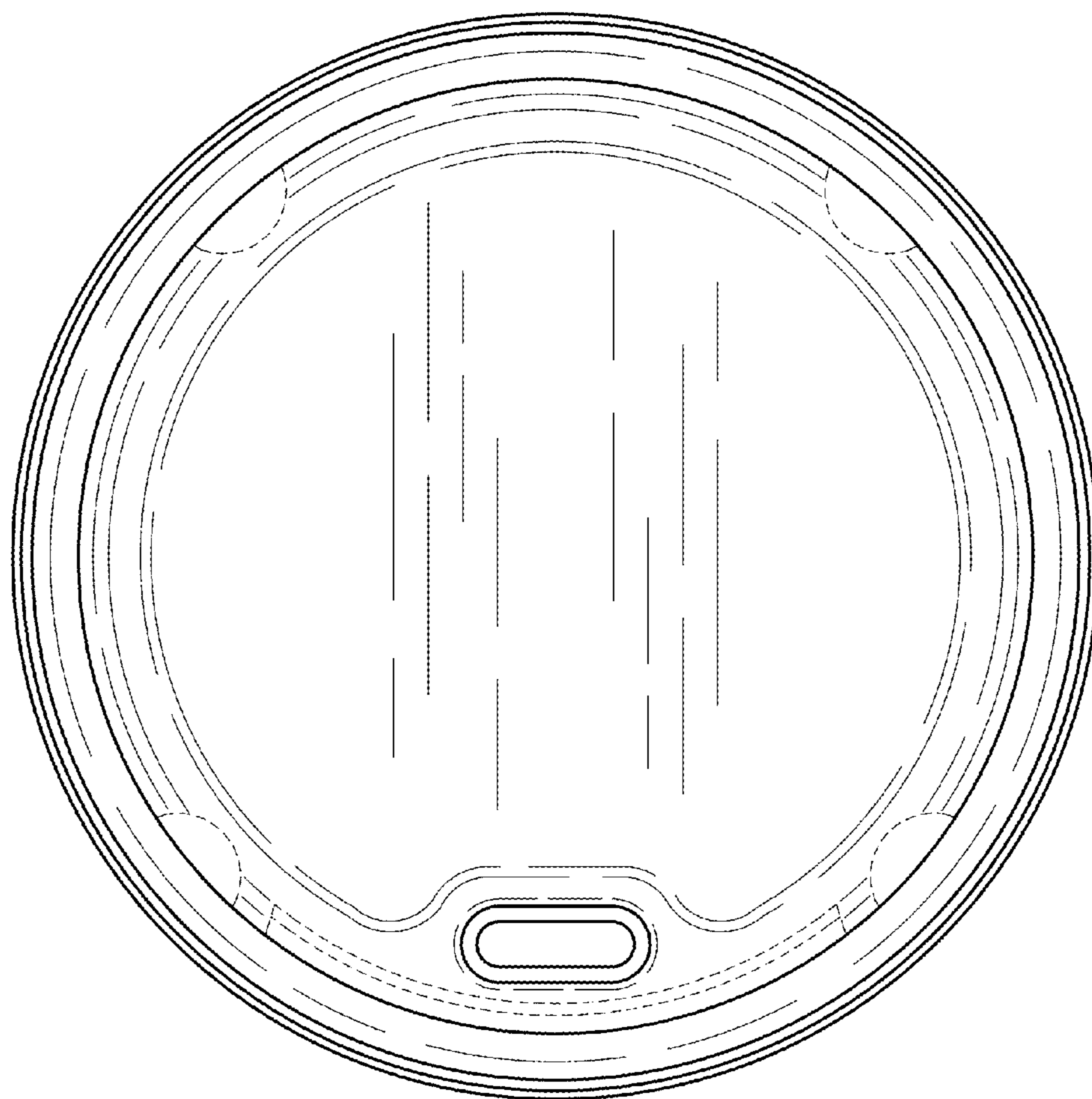

*Fig. 2*

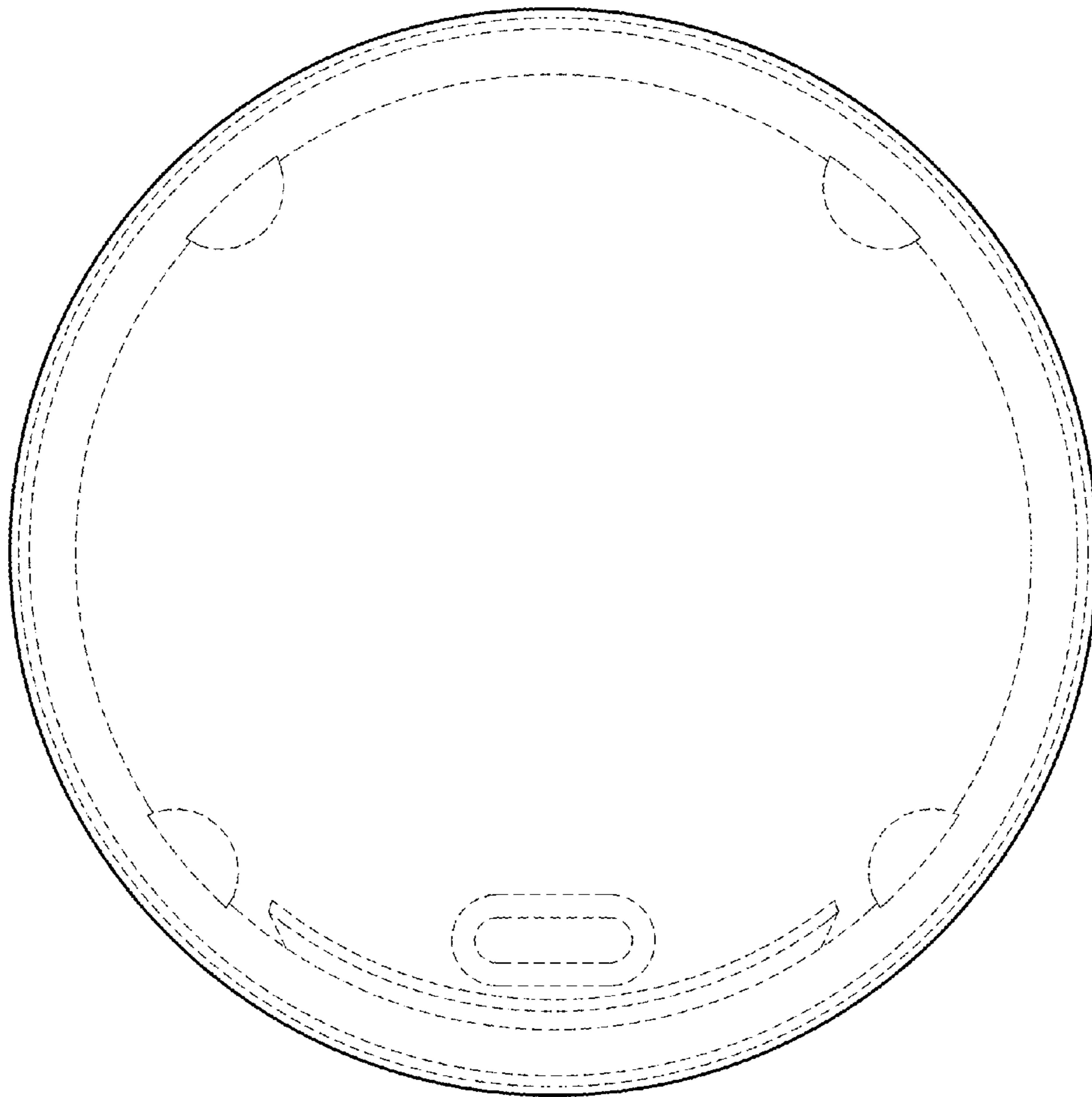
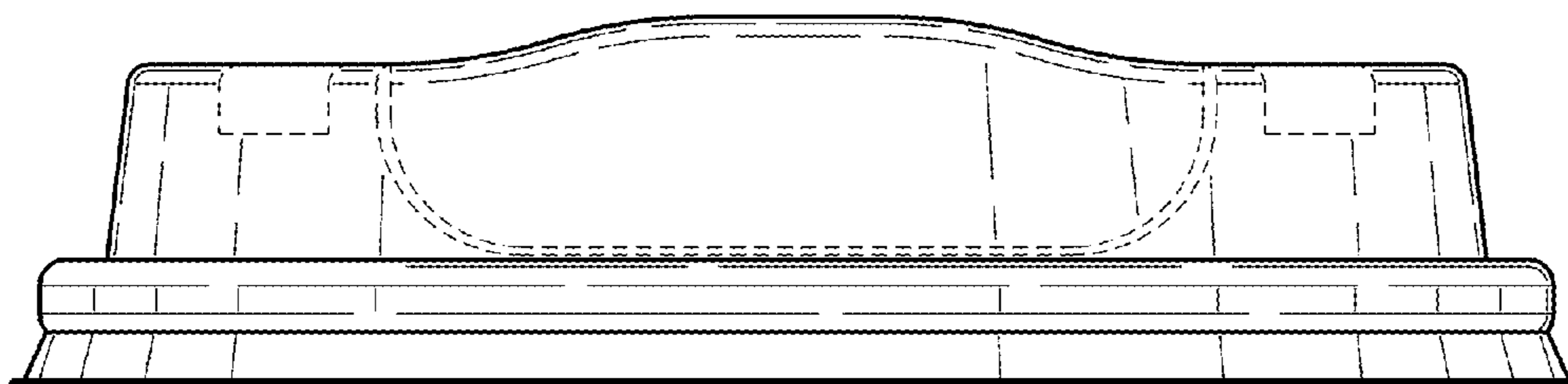
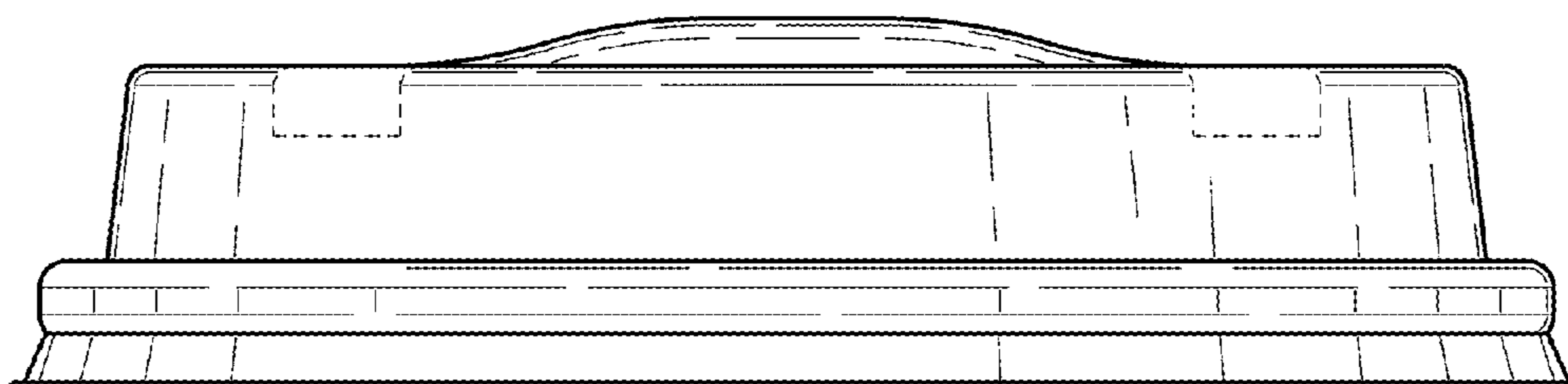

Fig. 3



*Fig. 4*



*Fig. 5*

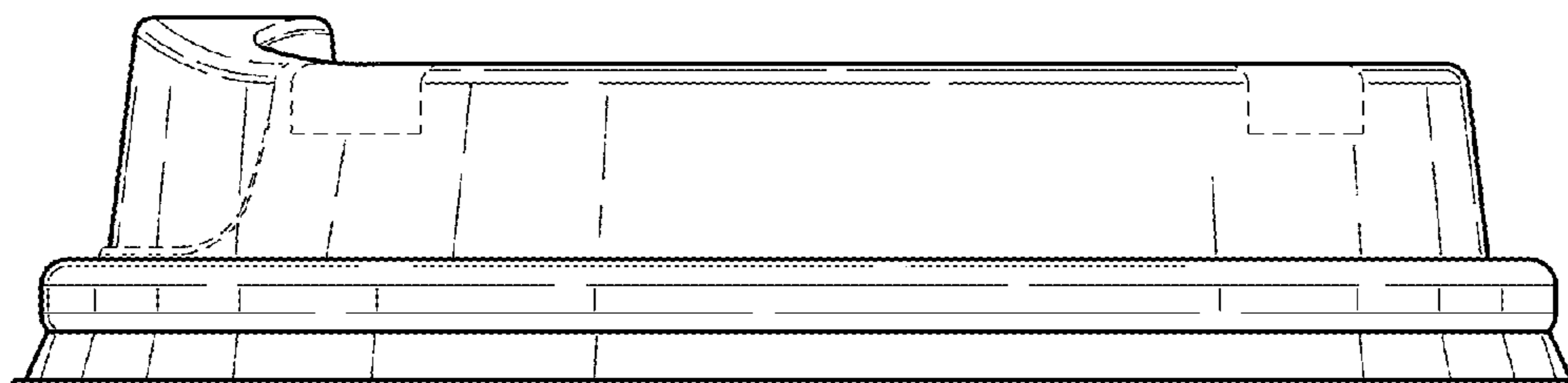

Fig. 6

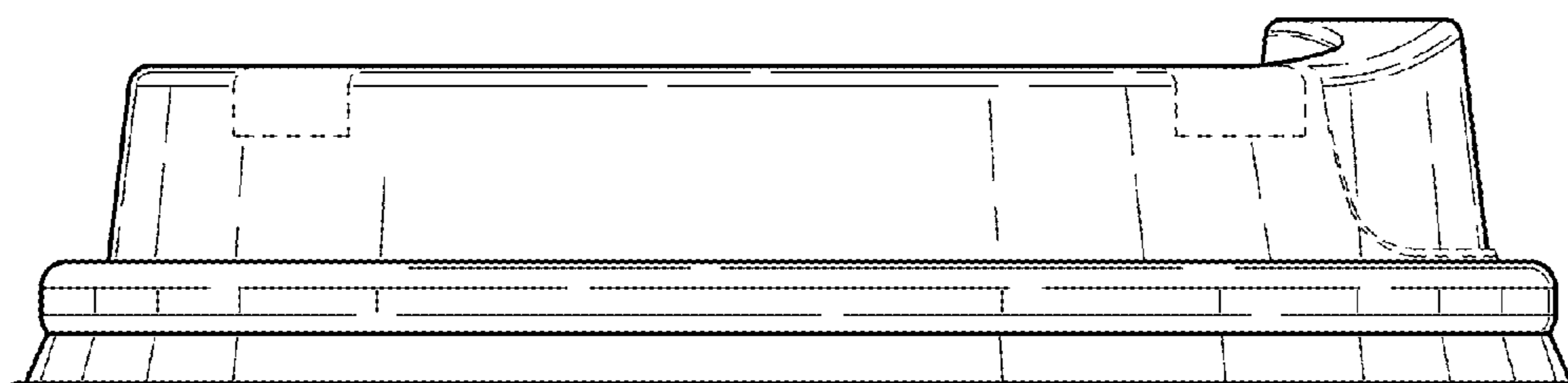

Fig. 7

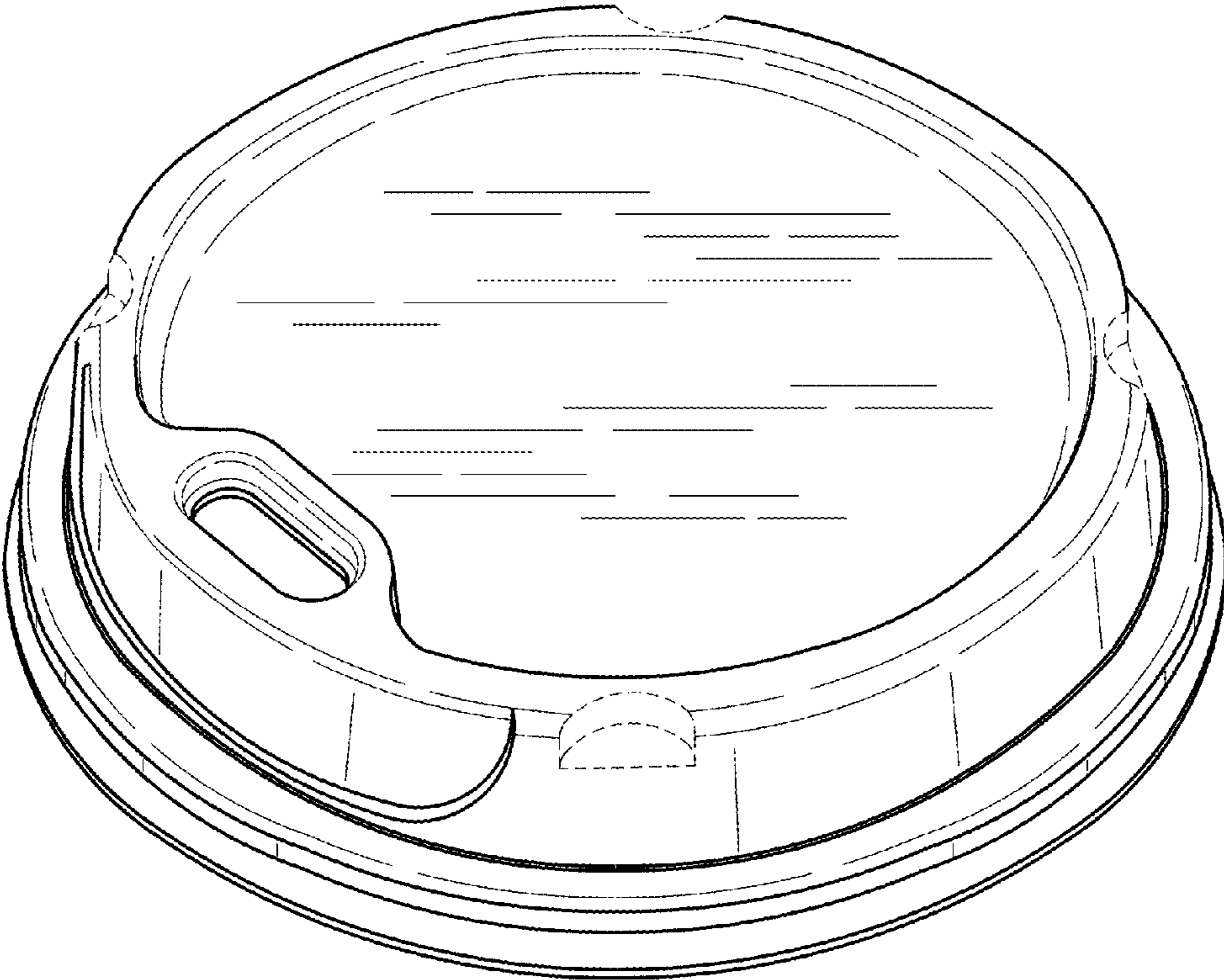
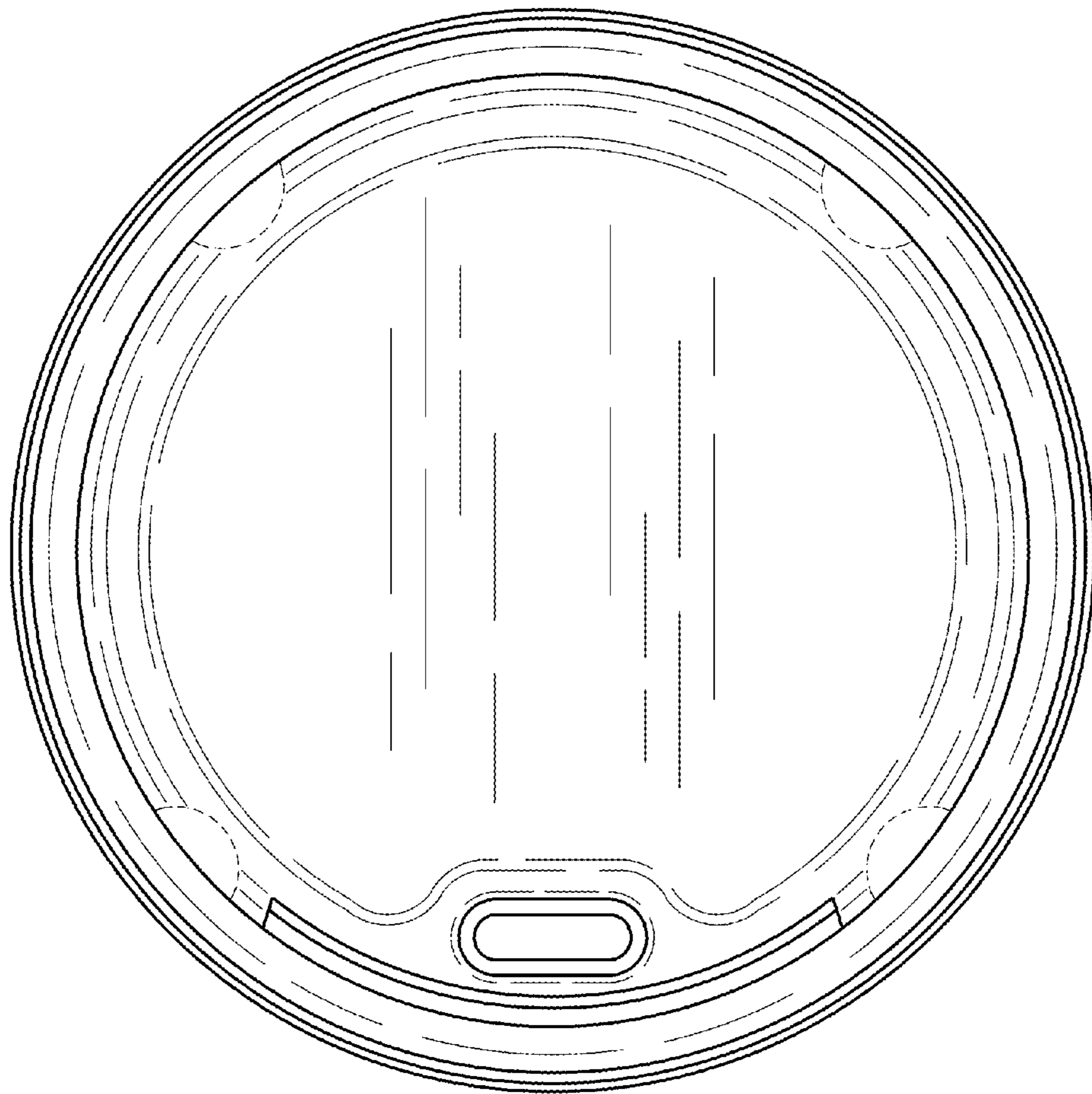
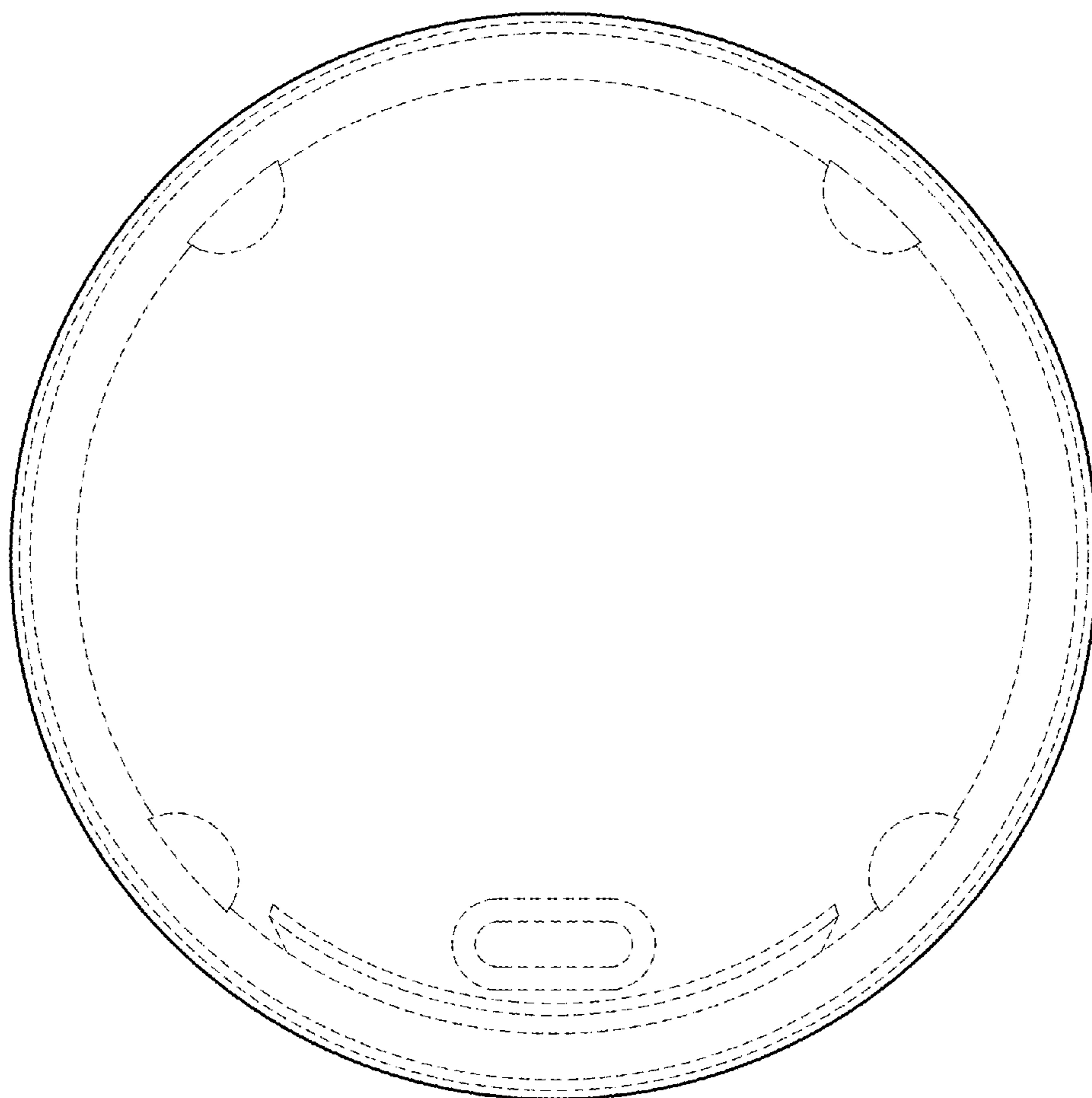

Fig. 8

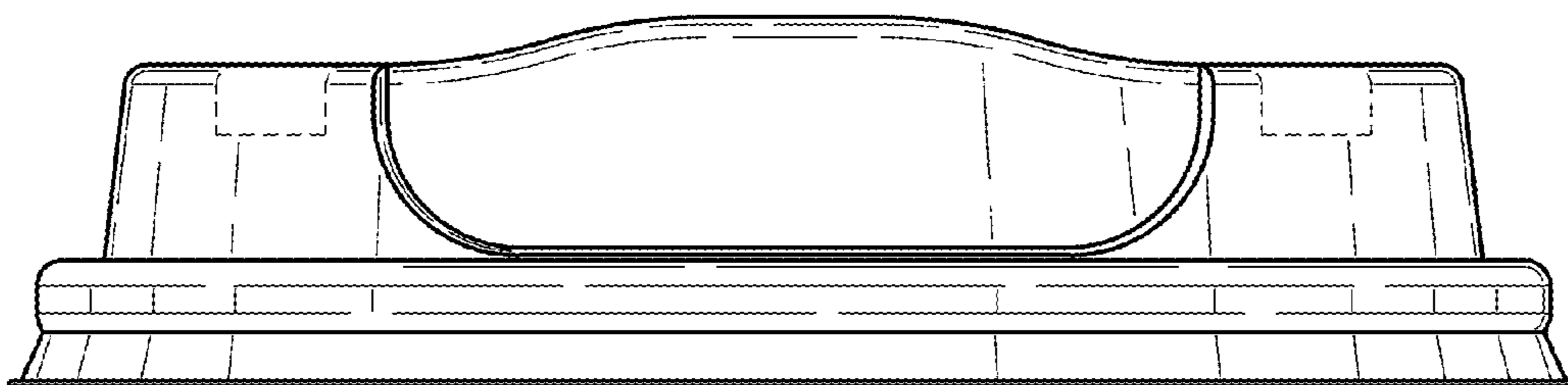



*Fig. 9*



*Fig. 10*



*Fig. 11*

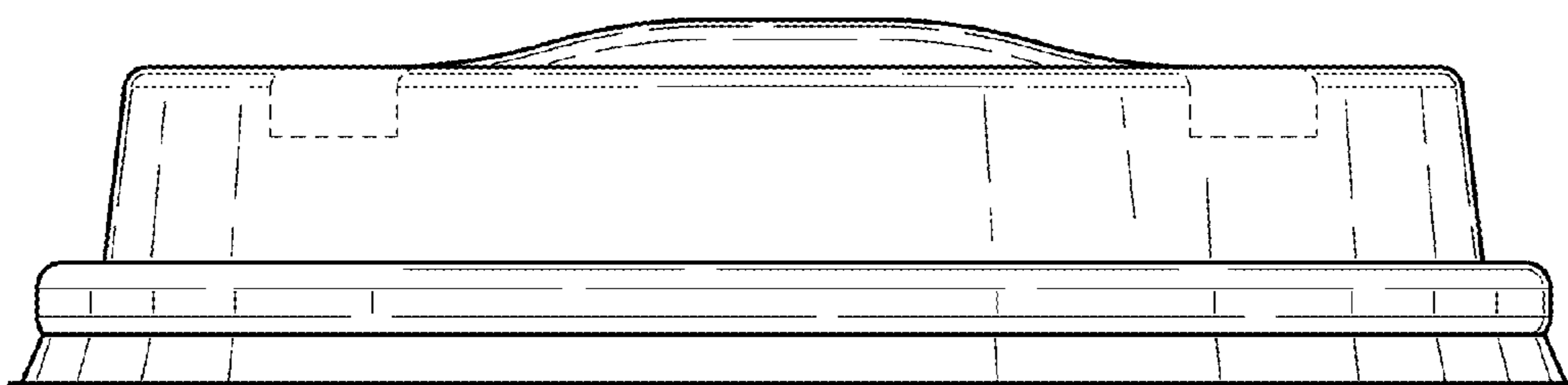

*Fig. 12*

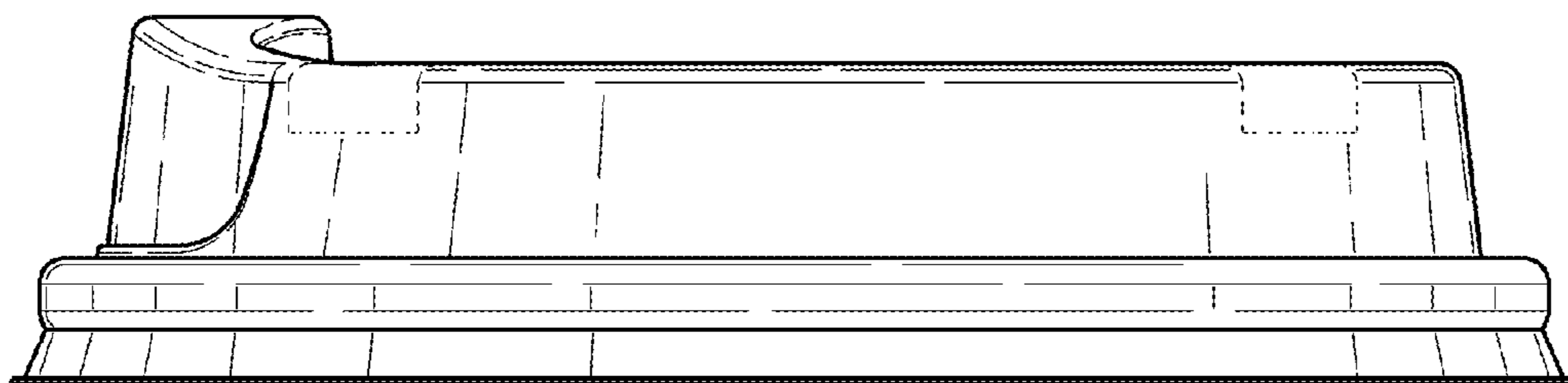

*Fig. 13*

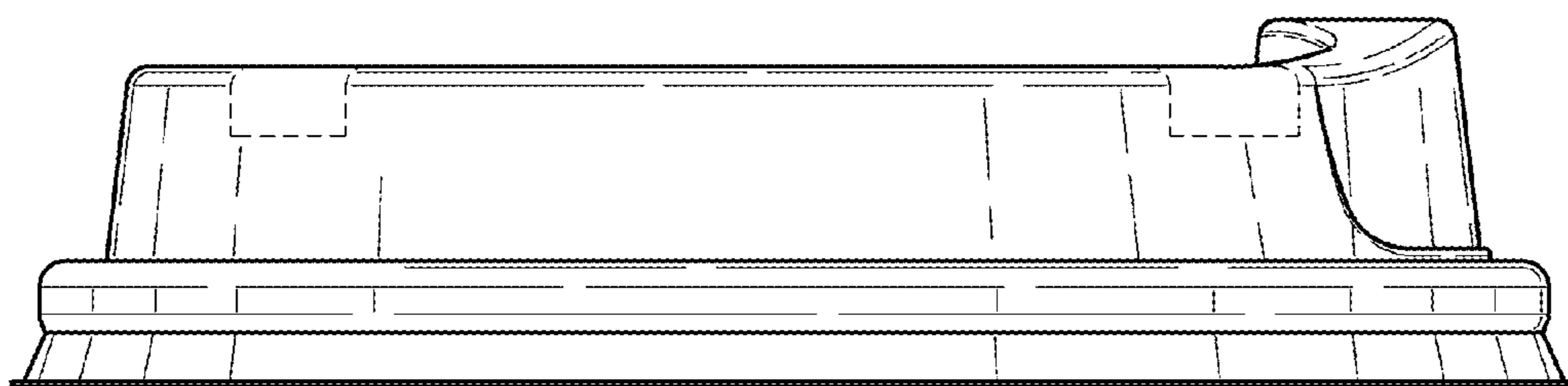

*Fig. 14*

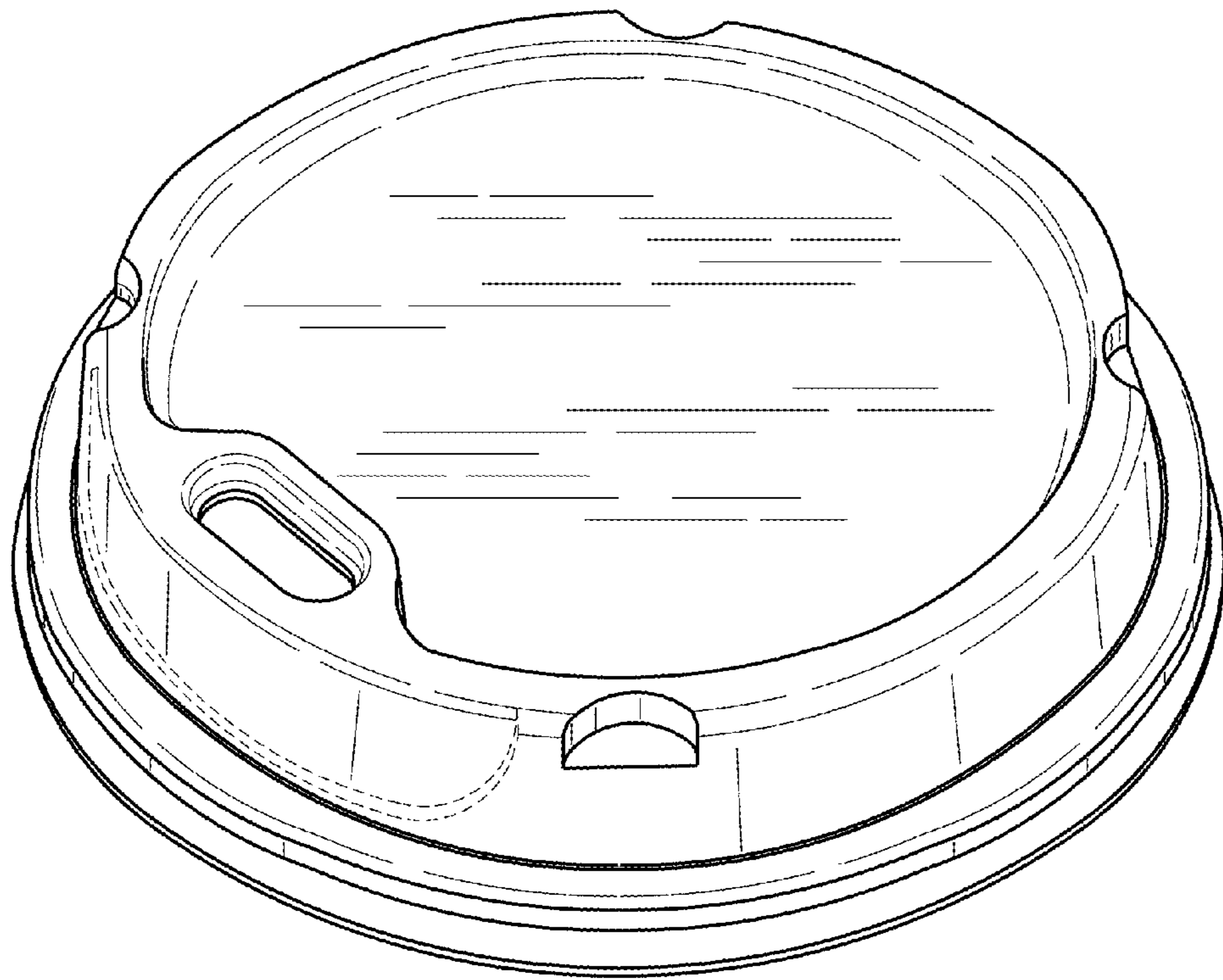

*Fig. 15*

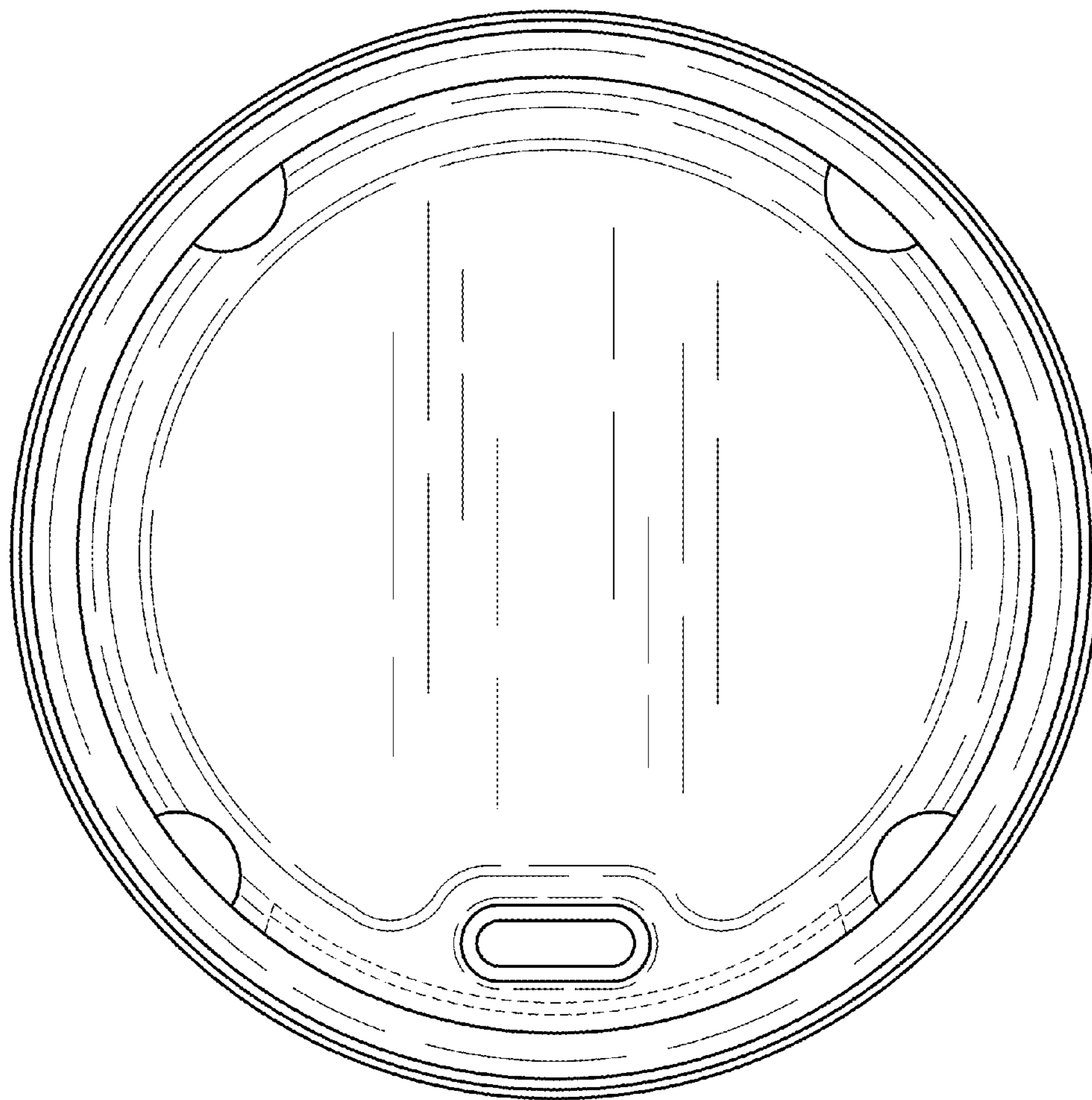

*Fig. 16*

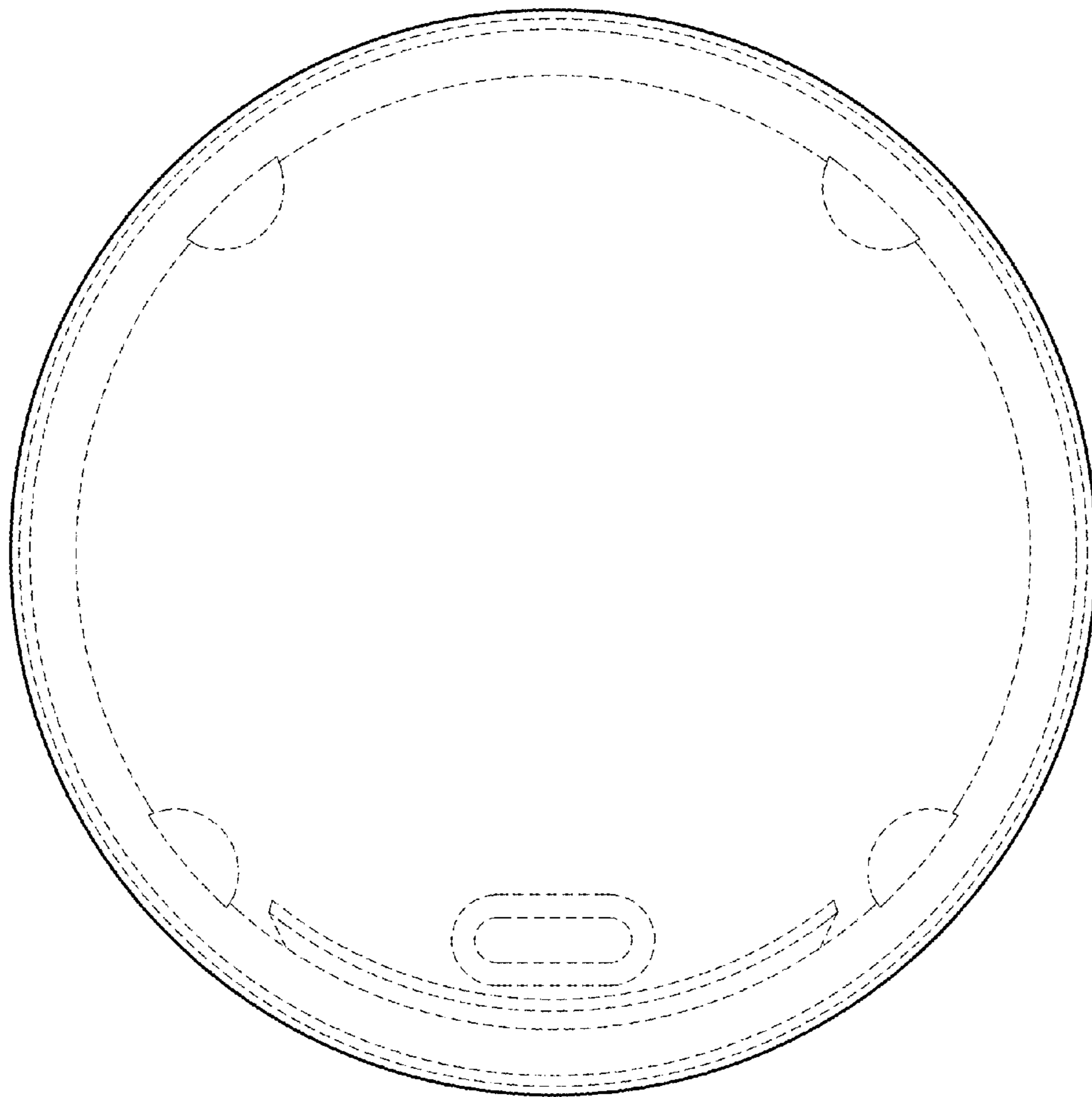

*Fig. 17*

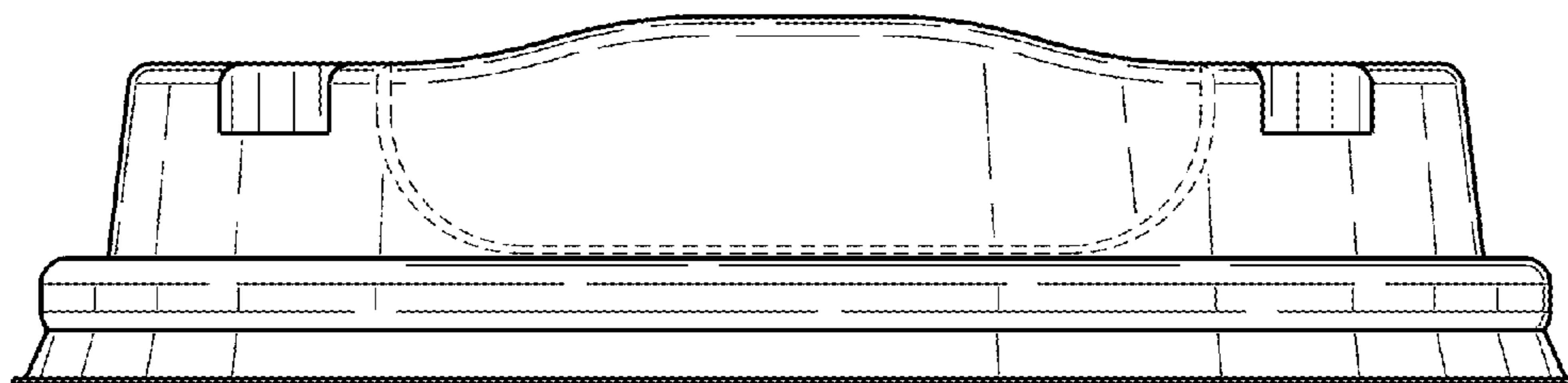

*Fig. 18*

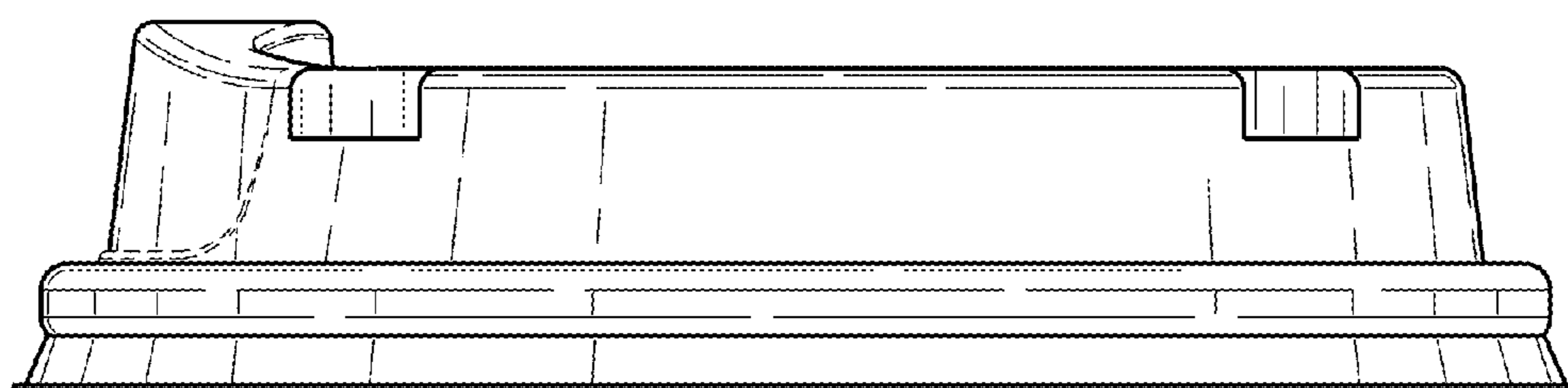

*Fig. 19*

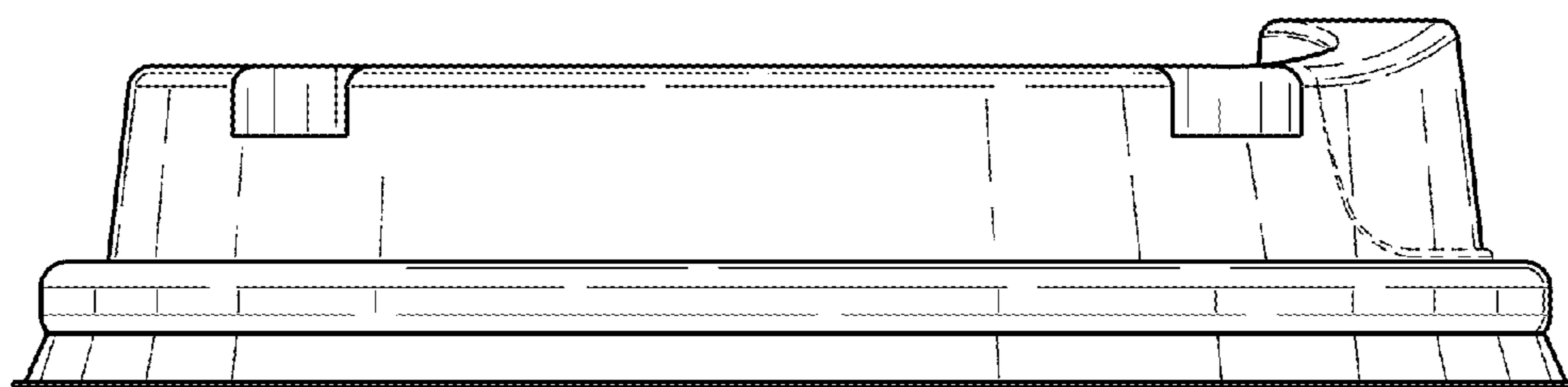

*Fig. 20*

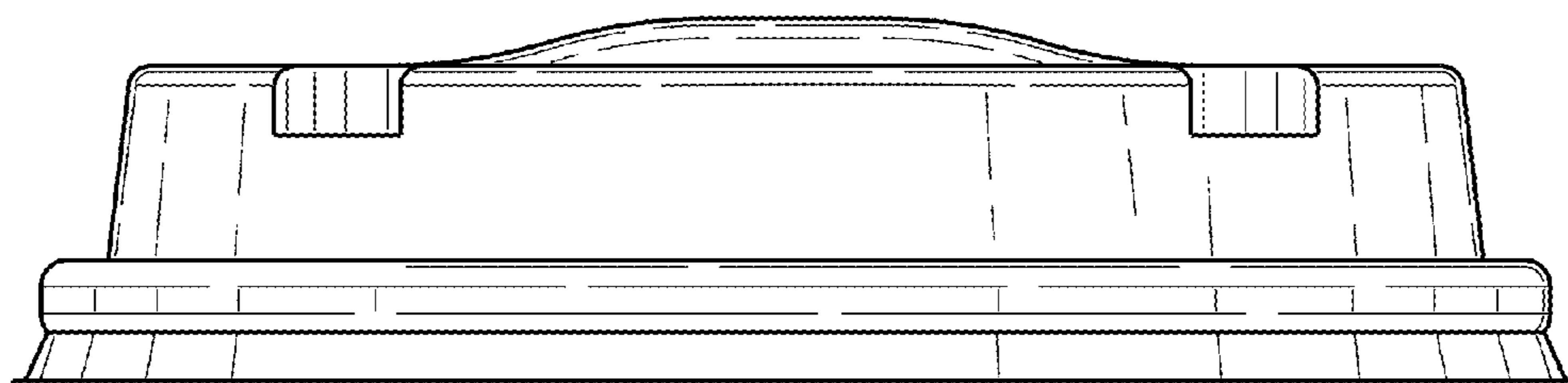

*Fig. 21*