



US00D716083S

(12) **United States Design Patent**
Hsu et al.

(10) **Patent No.:** **US D716,083 S**
(45) **Date of Patent:** **** Oct. 28, 2014**

- (54) **CORNER SHELF**
- (71) Applicant: **Seville Classics, Inc.**, Torrance, CA (US)
- (72) Inventors: **Li-Han Hsu**, Torrance, CA (US);
Cynthia J. Luff, Redondo Beach, CA (US)
- (73) Assignee: **Seville Classics Inc.**, Torrance, CA (US)
- (**) Term: **14 Years**
- (21) Appl. No.: **29/488,419**
- (22) Filed: **Apr. 18, 2014**
- (51) **LOC (10) Cl.** **06-06**
- (52) **U.S. Cl.**
USPC **D6/678.4**
- (58) **Field of Classification Search**
USPC D6/396, 449, 462, 491-492, 509-511,
D6/672, 676, 676.5, 678, 678.4;
108/153.1, 155-156, 157.1, 150, 161;
248/188, 188.1
See application file for complete search history.

D285,036 S *	8/1986	Gilchrist et al.	D7/554.1
D316,345 S *	4/1991	Mo Yau Kee	D6/465
D352,409 S *	11/1994	Hosoe	D6/482
D407,251 S *	3/1999	Hampshire	D6/540
D444,017 S *	6/2001	Walker	D6/562
D488,647 S *	4/2004	Ford et al.	D6/489
6,722,042 B1 *	4/2004	Naville et al.	30/280
D536,873 S *	2/2007	Thorsteinsson et al.	D3/306
D540,072 S *	4/2007	Steinman	D6/487
D572,940 S *	7/2008	Murray	D6/462
D585,670 S *	2/2009	Gharabegian	D6/489
D638,640 S *	5/2011	Molayem	D6/465
D701,714 S *	4/2014	Gelman	D6/676.1

* cited by examiner

Primary Examiner — Kelley Donnelly
(74) *Attorney, Agent, or Firm* — Raymond Sun

(57) **CLAIM**
The ornamental design for a corner shelf, as shown and described.

DESCRIPTION

FIG. 1 is a perspective view of a corner shelf showing our new design.
FIG. 2 is a front plan view thereof;
FIG. 3 is a right plan view thereof;
FIG. 4 is a left plan view thereof;
FIG. 5 is a top plan view thereof;
FIG. 6 is a bottom plan view thereof; and,
FIG. 7 is a rear plan view thereof.

1 Claim, 7 Drawing Sheets

- (56) **References Cited**
U.S. PATENT DOCUMENTS
2,710,733 A * 6/1955 Phillips 248/431
D267,211 S * 12/1982 Farrell D6/468
D280,164 S * 8/1985 Berry, Jr. D6/489

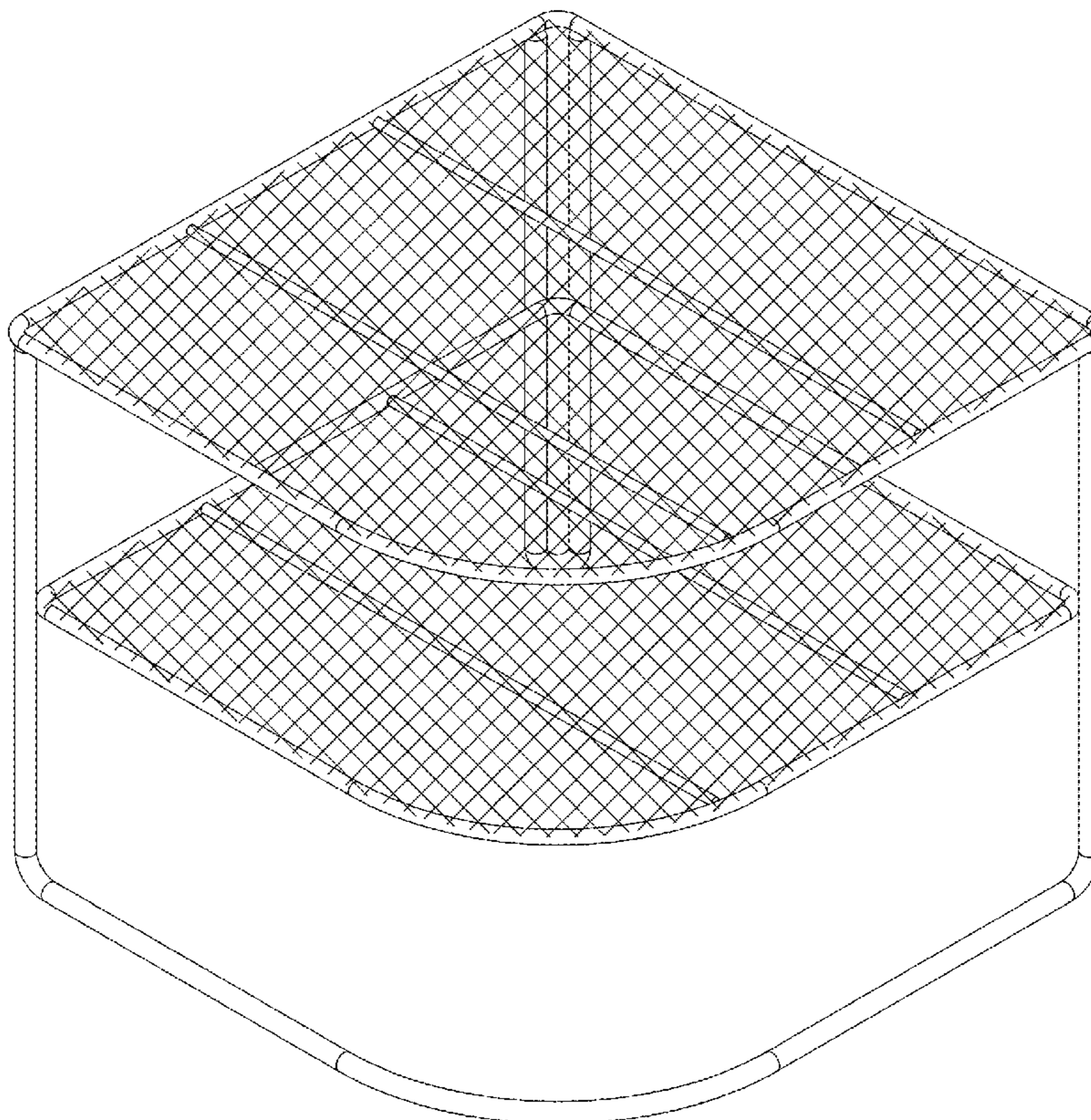

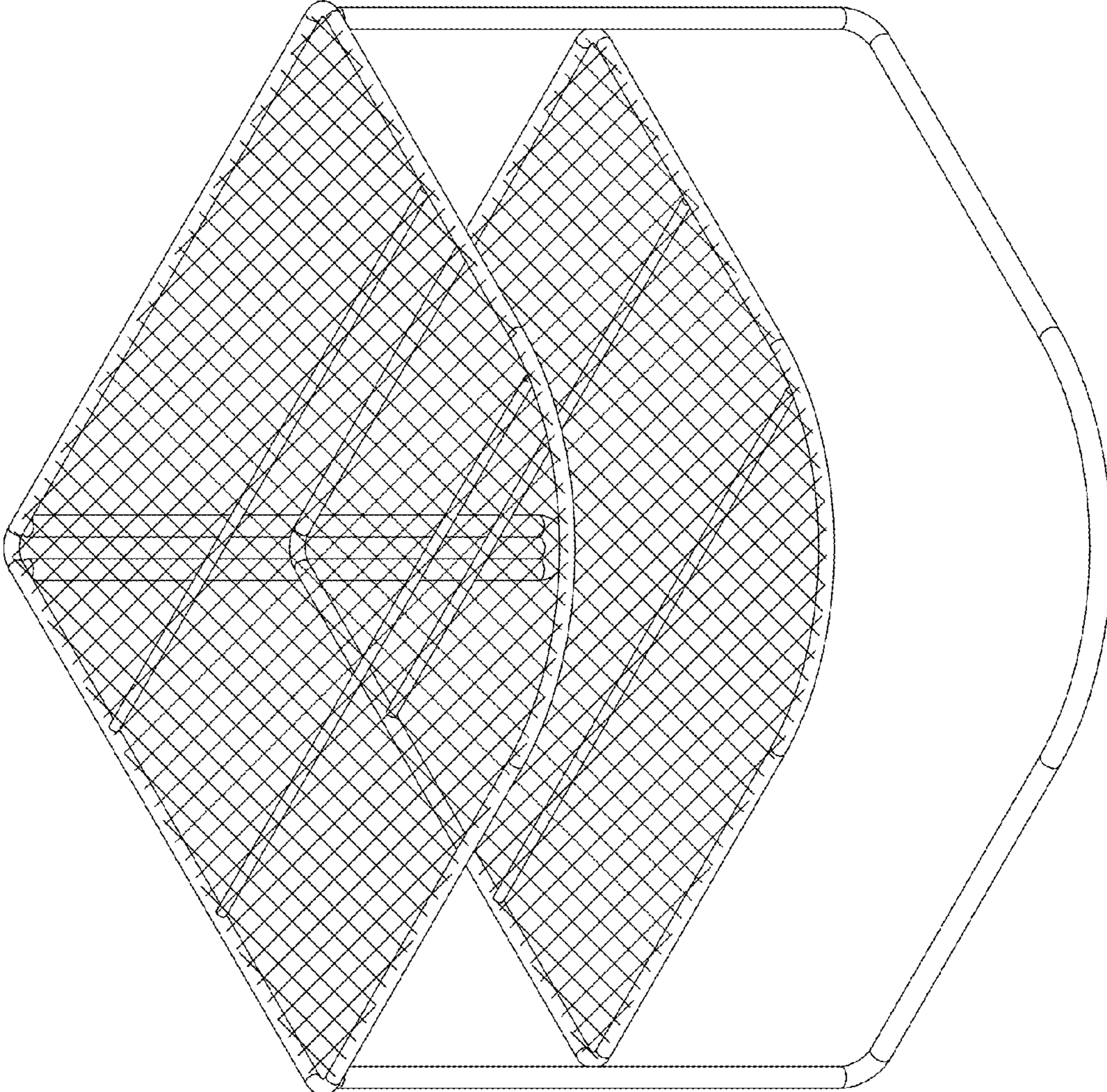

FIG. 1

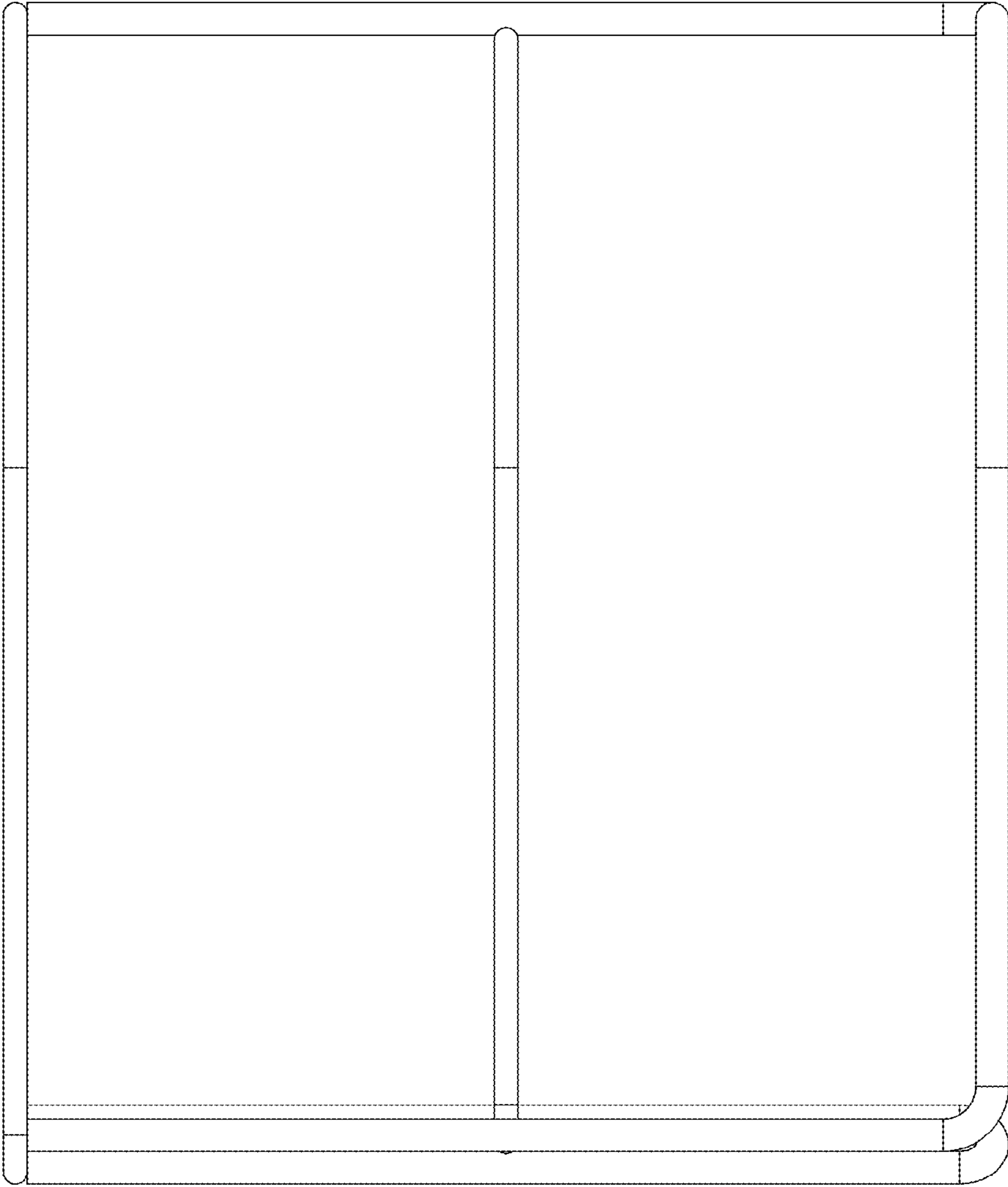

FIG. 2

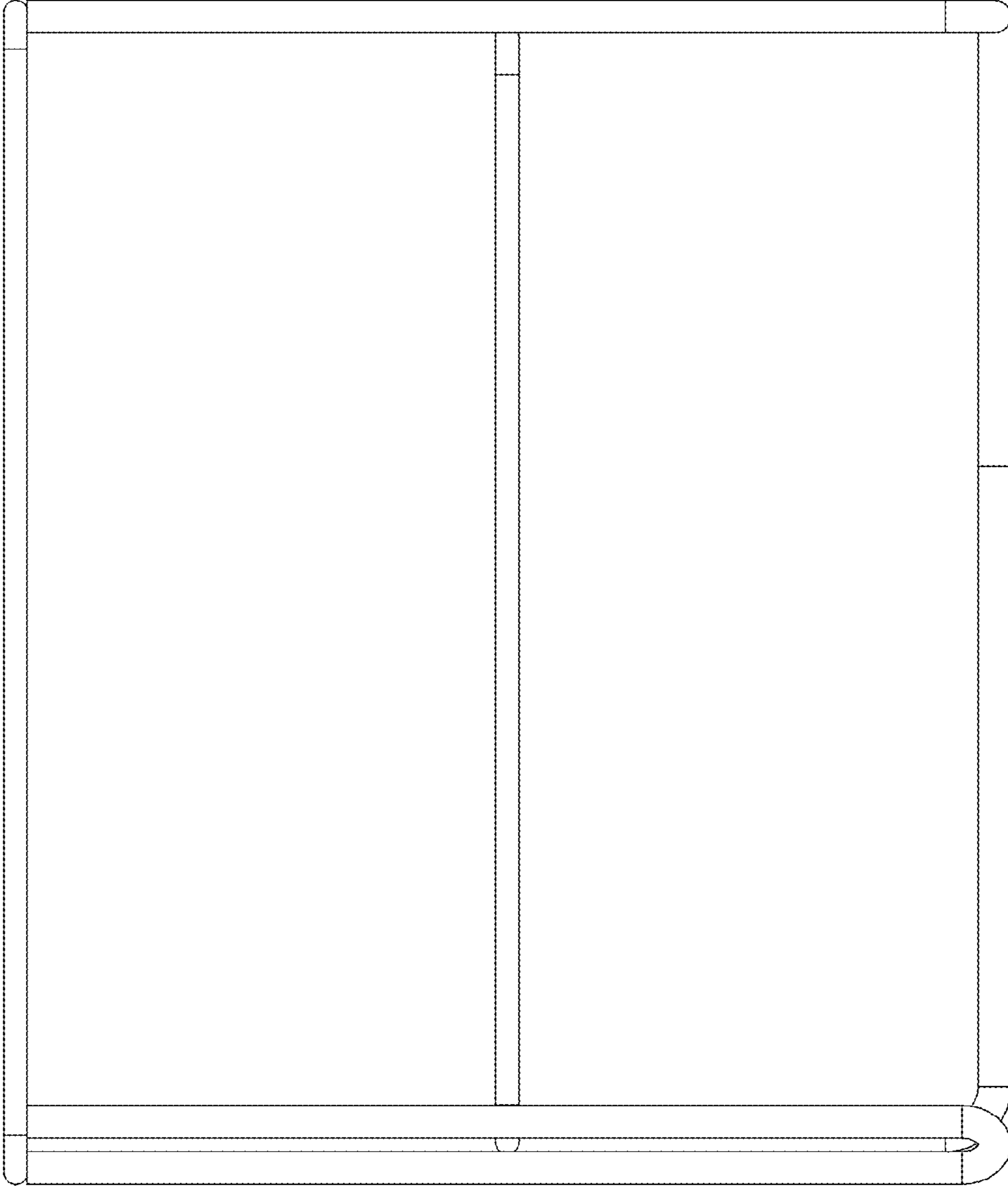

FIG. 3

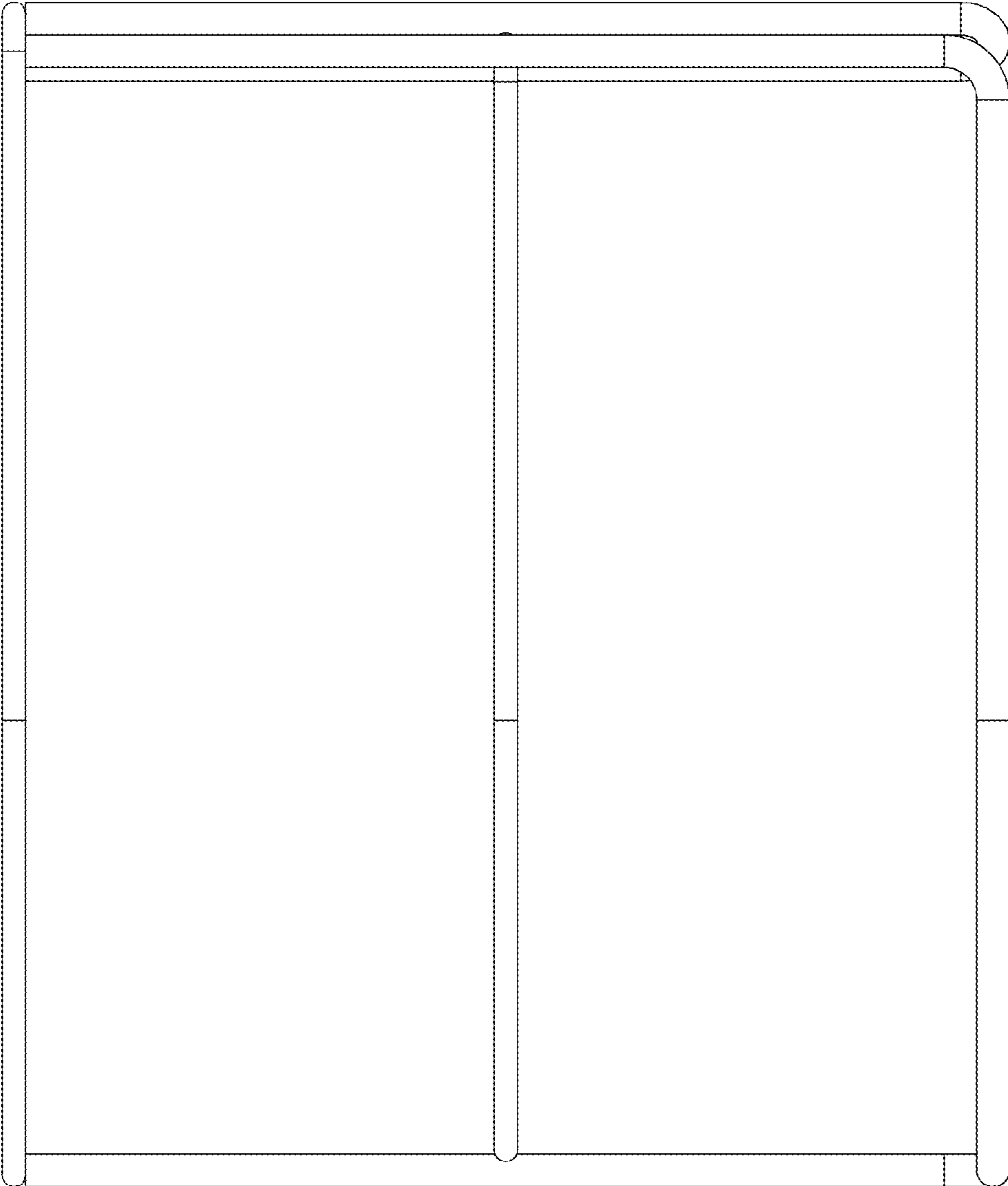

FIG. 4

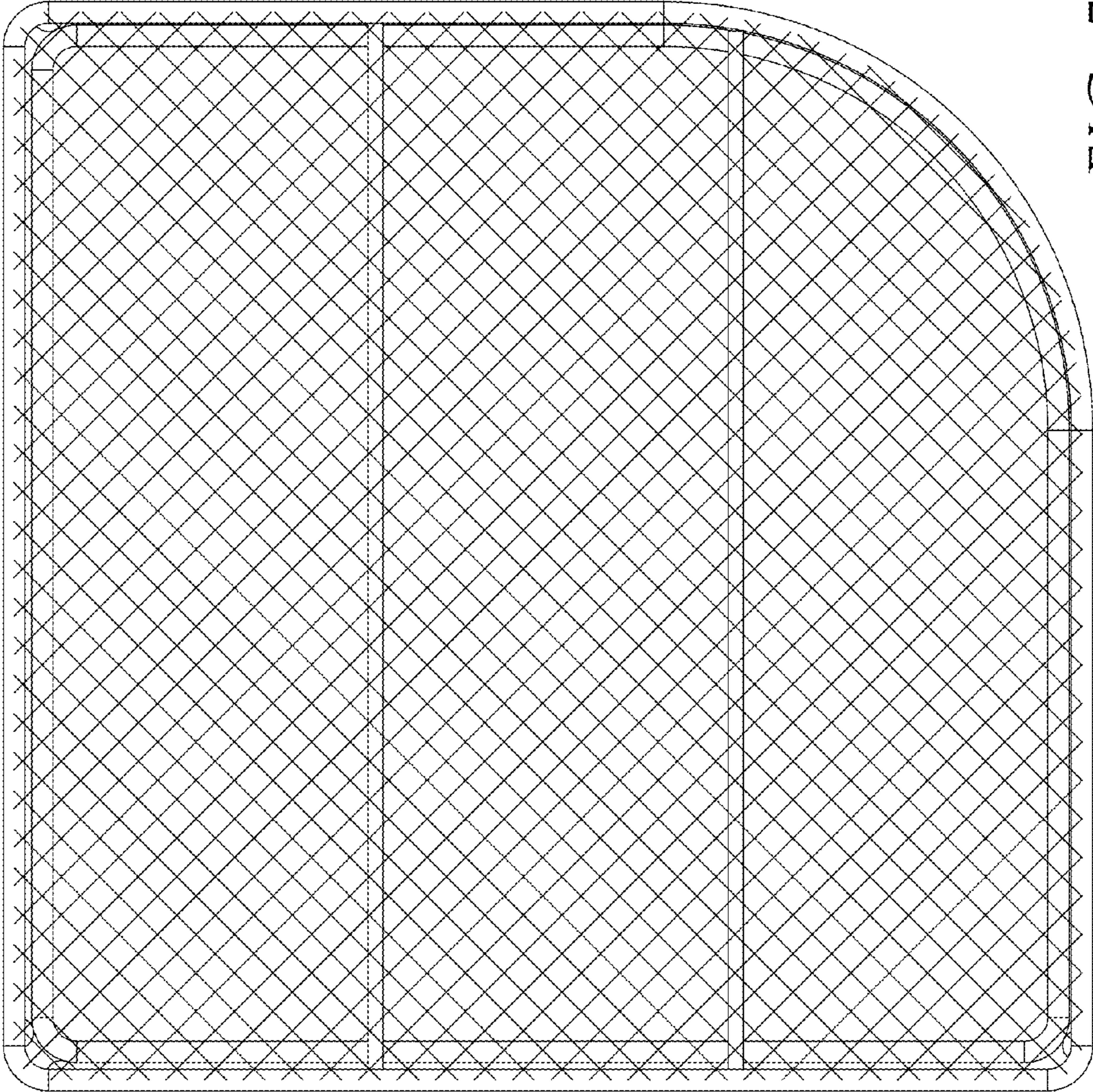
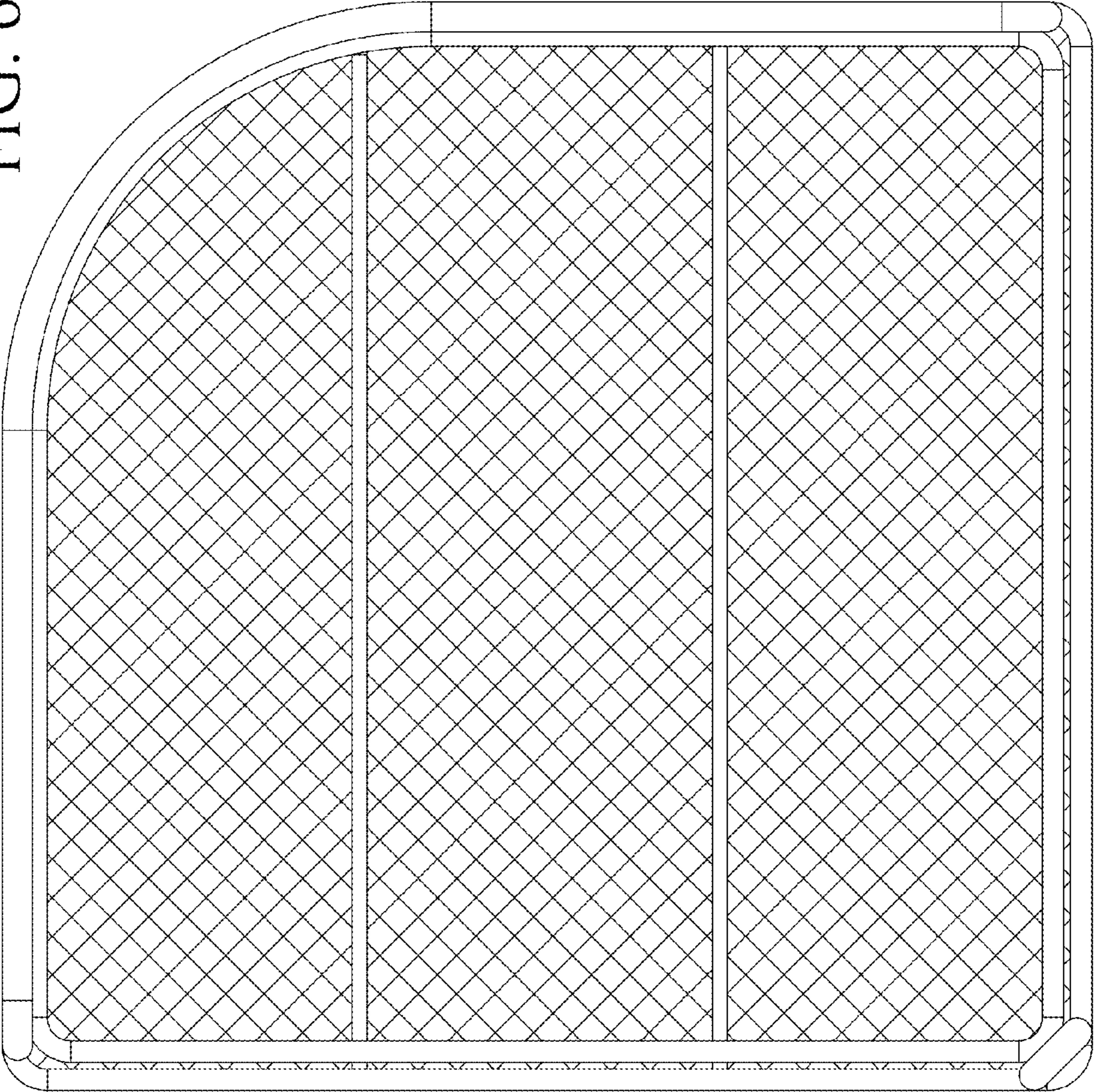

FIG. 5

FIG. 6



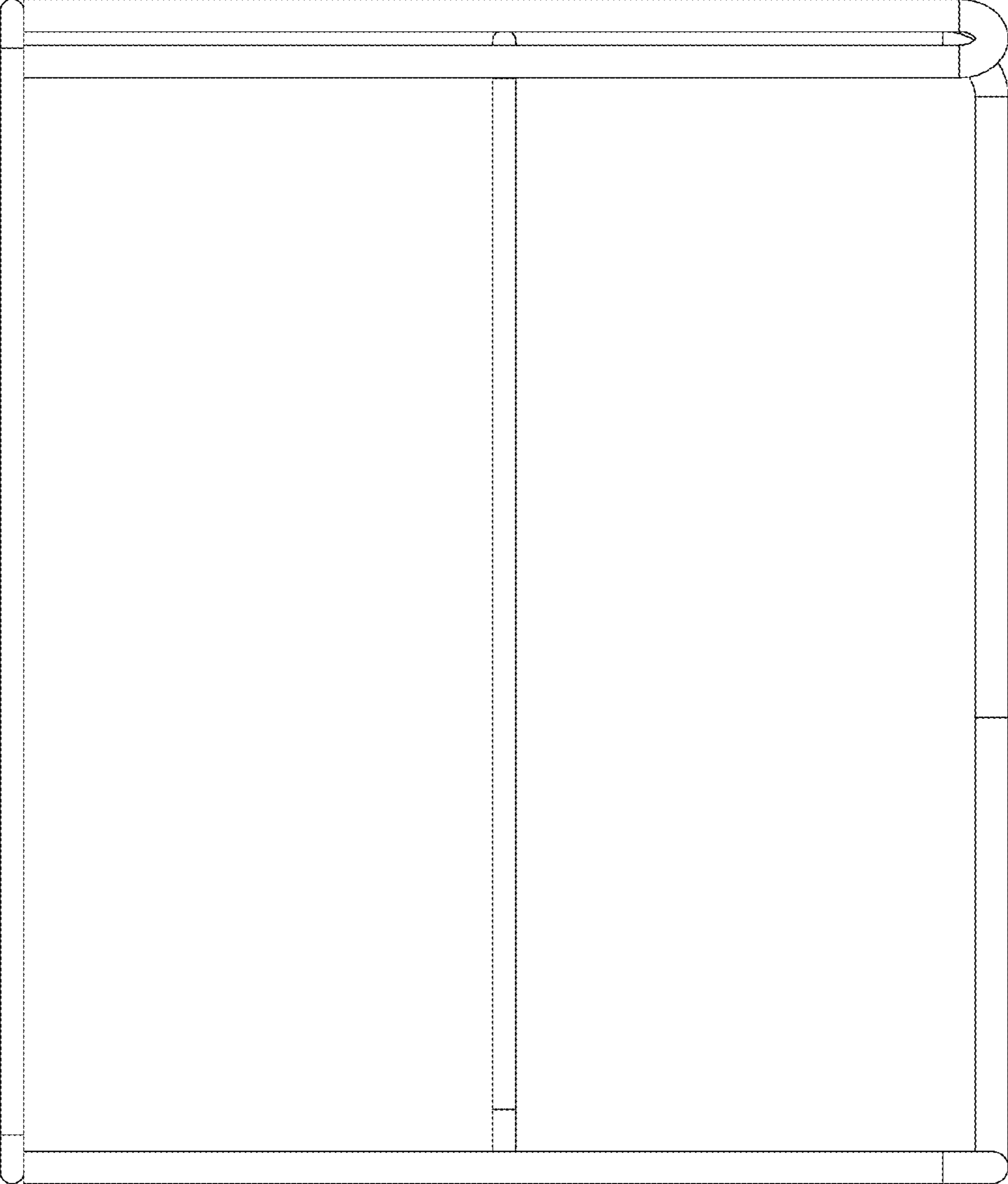

FIG. 7