



US00D716080S

(12) **United States Design Patent**
Bell et al.

(10) **Patent No.:** **US D716,080 S**
(45) **Date of Patent:** **** Oct. 28, 2014**

- (54) **FOLDABLE DISPLAY RACK**
- (71) Applicant: **JAB Distributors, LLC**, Wheeling, IL (US)
- (72) Inventors: **Warrick Bell**, Northbrook, IL (US);
James Bell, Glencoe, IL (US)
- (73) Assignee: **JAB Distributors, LLC**
- (**) Term: **14 Years**
- (21) Appl. No.: **29/491,145**
- (22) Filed: **May 16, 2014**
- (51) **LOC (10) Cl.** **06-06**
- (52) **U.S. Cl.**
USPC **D6/675.1**
- (58) **Field of Classification Search**
USPC D6/449, 455, 457, 464, 470-472,
D6/474-475, 477, 567, 675-675.1;
108/107, 144.11, 149, 59, 161, 108;
312/107, 114; 211/59.4, 134, 69,
211/186-192
See application file for complete search history.

| | | | |
|----------------|---------|-------------------------|----------|
| D623,439 S * | 9/2010 | Daniel et al. | D6/465 |
| D631,680 S * | 2/2011 | Walsh | D6/477 |
| D635,377 S * | 4/2011 | Rodgers et al. | D6/468 |
| D635,801 S * | 4/2011 | Stubis | D6/461 |
| D651,024 S * | 12/2011 | Shenkin | D6/474 |
| D657,591 S * | 4/2012 | Sanchez | D6/479 |
| D668,476 S * | 10/2012 | Carlshamre | D6/476 |
| D670,511 S * | 11/2012 | Hansen, Jr. | D6/477 |
| D675,040 S * | 1/2013 | Koenigsknecht et al. .. | D6/675.1 |
| D682,584 S * | 5/2013 | Hansen, Jr. | D6/675.1 |
| D684,412 S * | 6/2013 | Hansen, Jr. | D6/673 |
| 8,651,298 B2 * | 2/2014 | Beaty | 211/135 |

* cited by examiner

Primary Examiner — Kelley Donnelly

(74) *Attorney, Agent, or Firm* — McAndrews, Held & Malloy, Ltd.

(57) **CLAIM**

The ornamental design for a foldable display rack, as shown and described.

DESCRIPTION

FIG. 1 is a perspective view of a foldable display rack; and FIG. 2 is a front view of the foldable display rack of FIG. 1. FIG. 3 is a right side view of the foldable display rack of FIG. 1, and which is a mirror image of the left side view of the foldable display rack of FIG. 1. FIG. 4 is a top view of the foldable display rack of FIG. 1. FIG. 5 is a bottom view of the foldable display rack of FIG. 1. FIG. 6 is a back view of the foldable display rack of FIG. 1; and, FIG. 7 is a perspective view of the foldable display rack in a folded position. The broken lines showing on the upper element in FIG. 1 are for the purposes of illustrating the environment of the article only and form no part of the claimed design.

1 Claim, 4 Drawing Sheets

(56) **References Cited**

U.S. PATENT DOCUMENTS

| | | | |
|--------------|---------|---------------------------|--------|
| D393,160 S * | 4/1998 | Canton Gongora et al. ... | D6/449 |
| D433,846 S * | 11/2000 | Chang | D6/474 |
| D486,673 S * | 2/2004 | Hessell | D6/474 |
| D492,138 S * | 6/2004 | Dardashti | D6/479 |
| D521,276 S * | 5/2006 | Lenger | D6/474 |
| D534,376 S * | 1/2007 | Sparkowski | D6/468 |
| D540,354 S * | 4/2007 | Rousselin | D15/81 |
| D560,402 S * | 1/2008 | Lev | D6/479 |
| D591,531 S * | 5/2009 | Sparkowski | D6/464 |
| D607,669 S * | 1/2010 | Trinh et al. | D6/477 |
| D608,115 S * | 1/2010 | Trinh et al. | D6/477 |

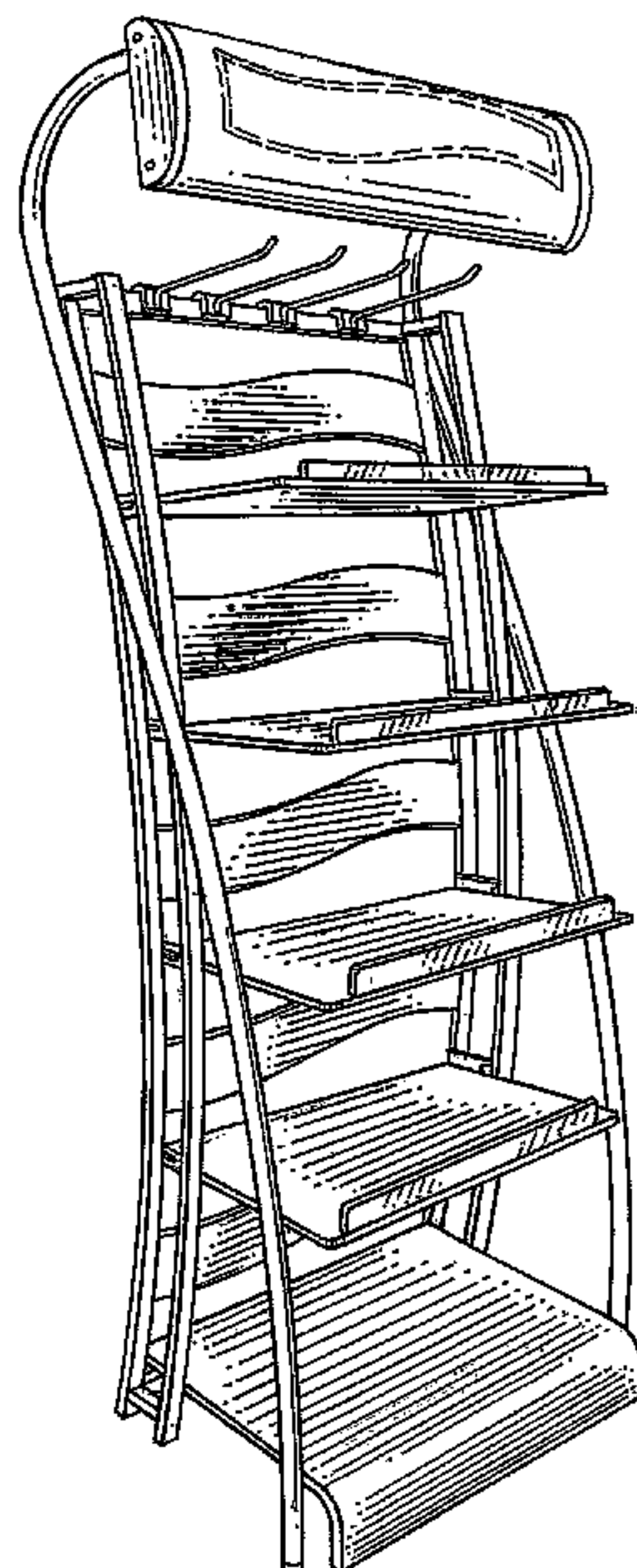

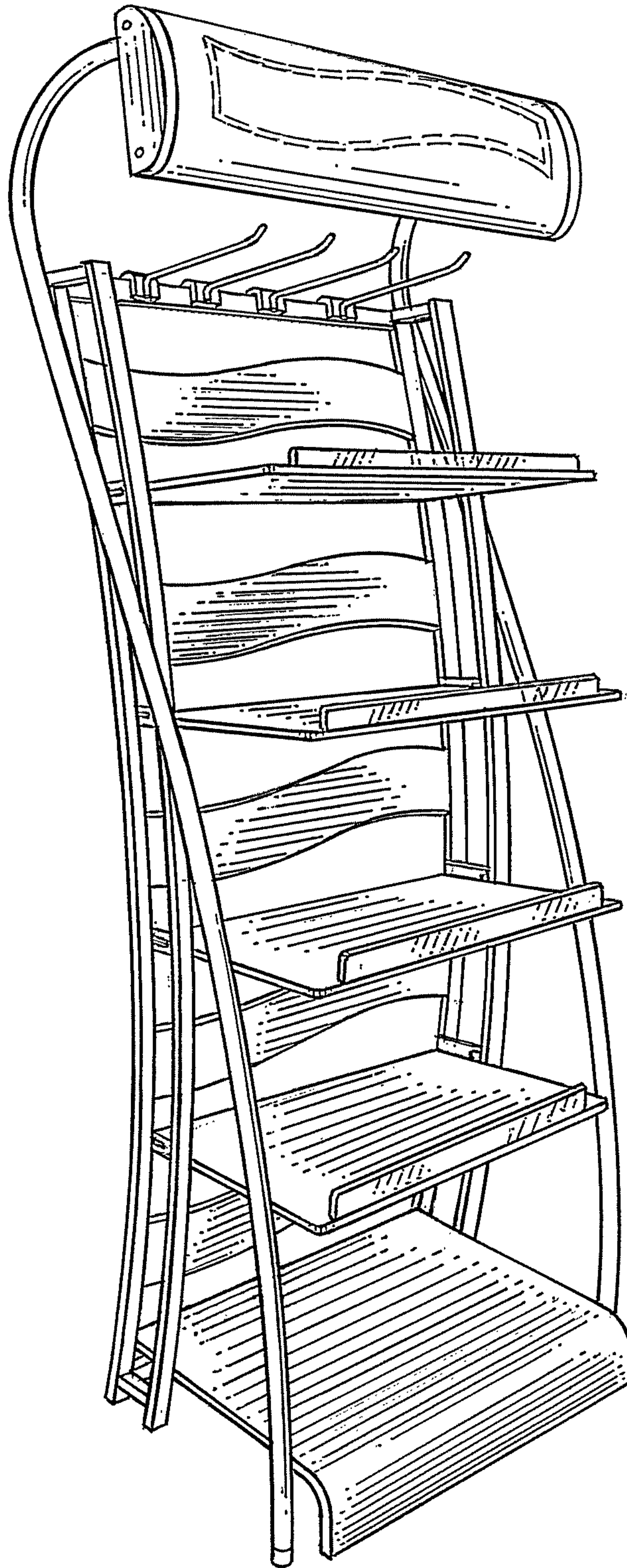

FIG.1

FIG.2

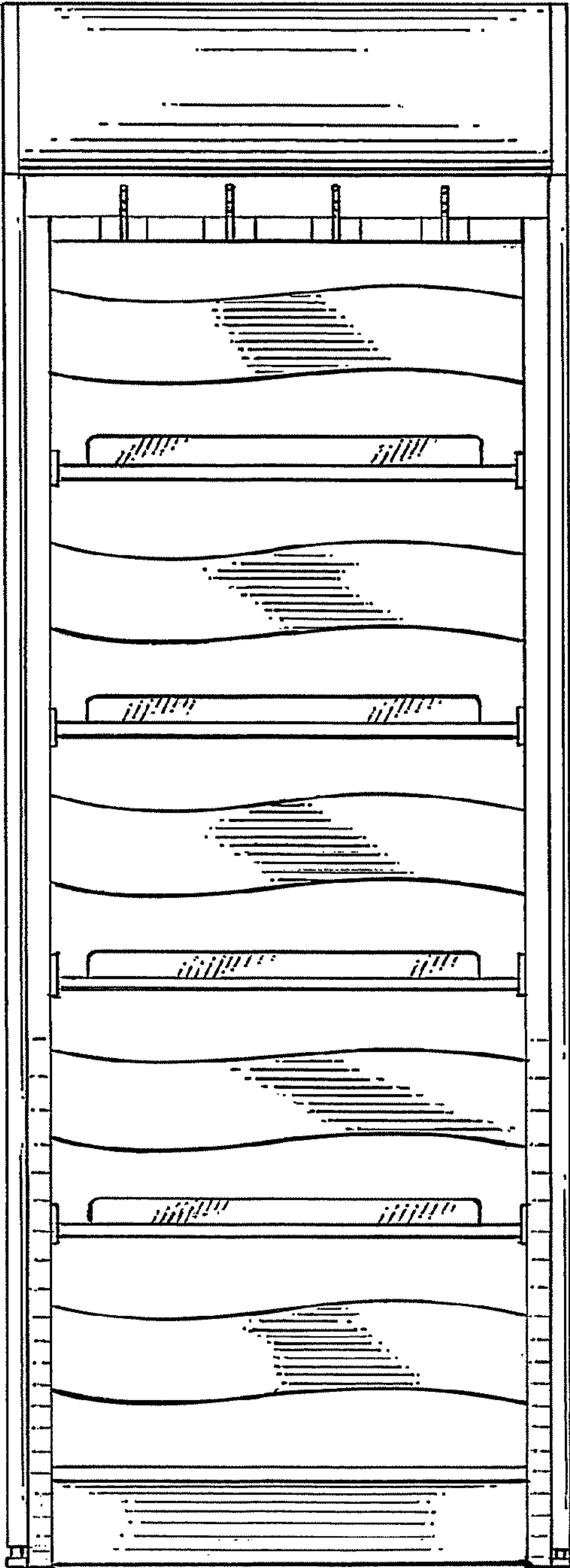

FIG.3

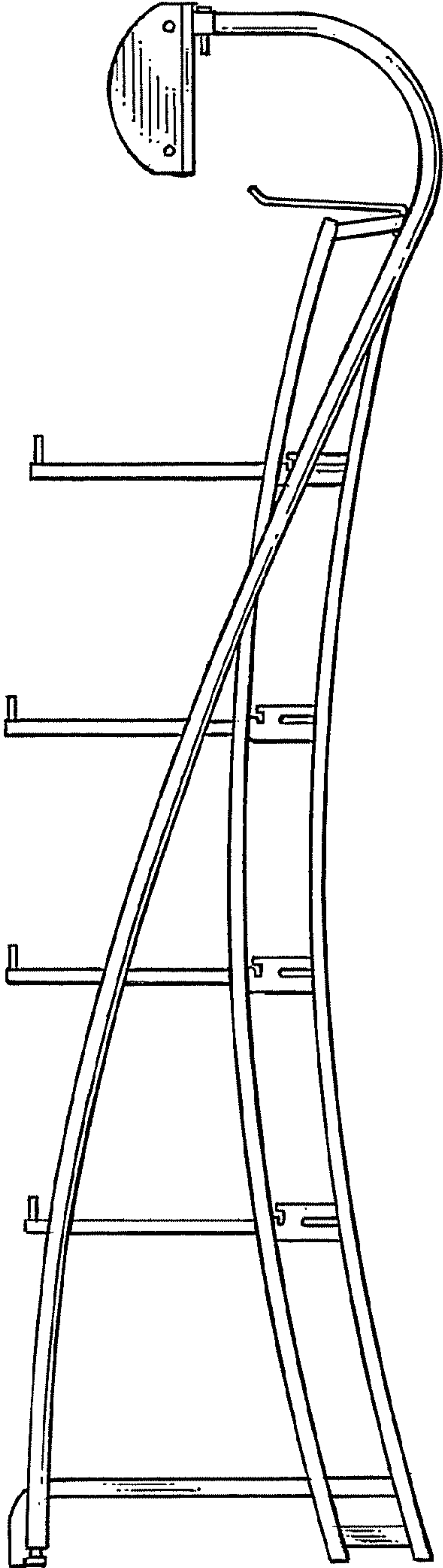

FIG.4

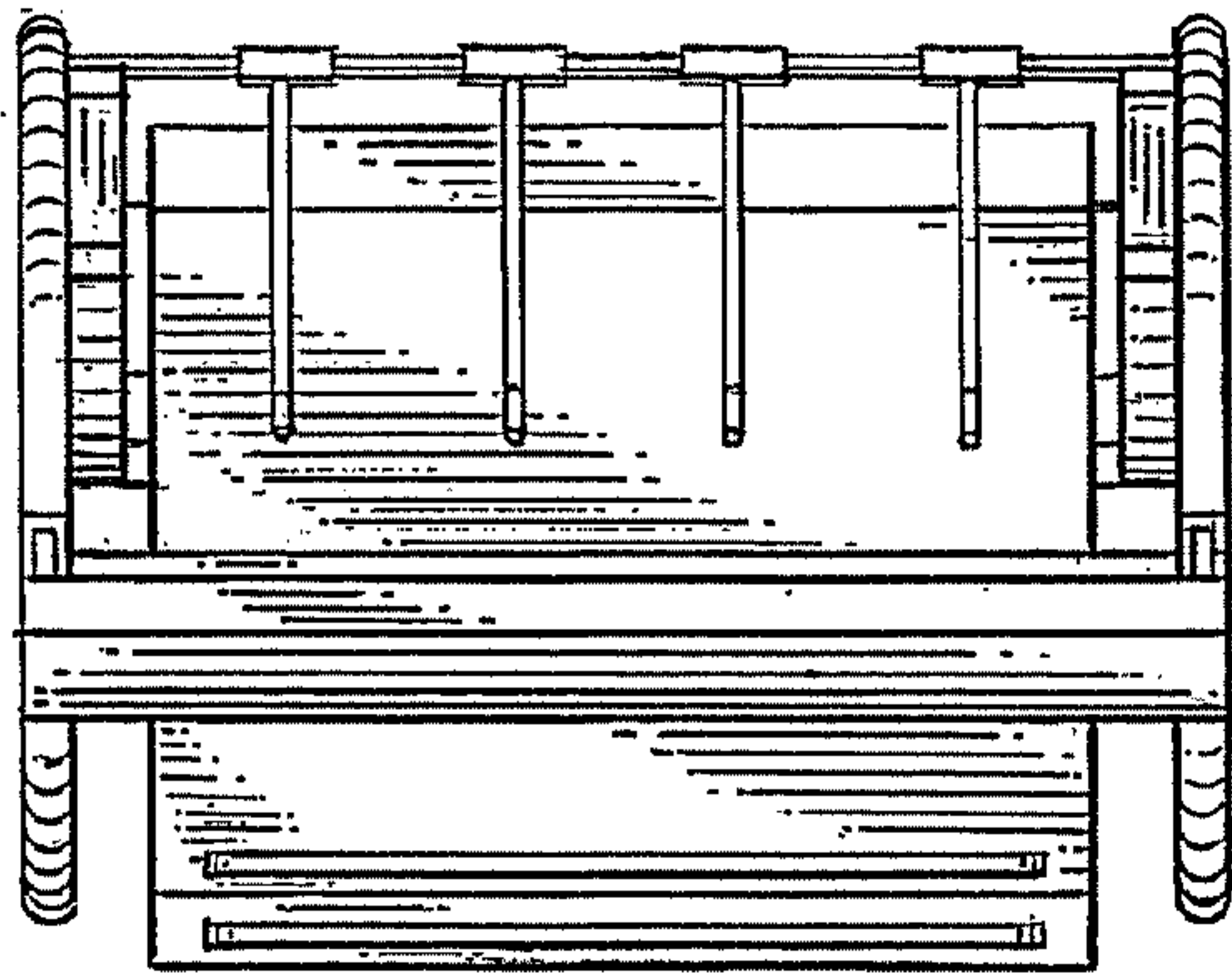

FIG.5

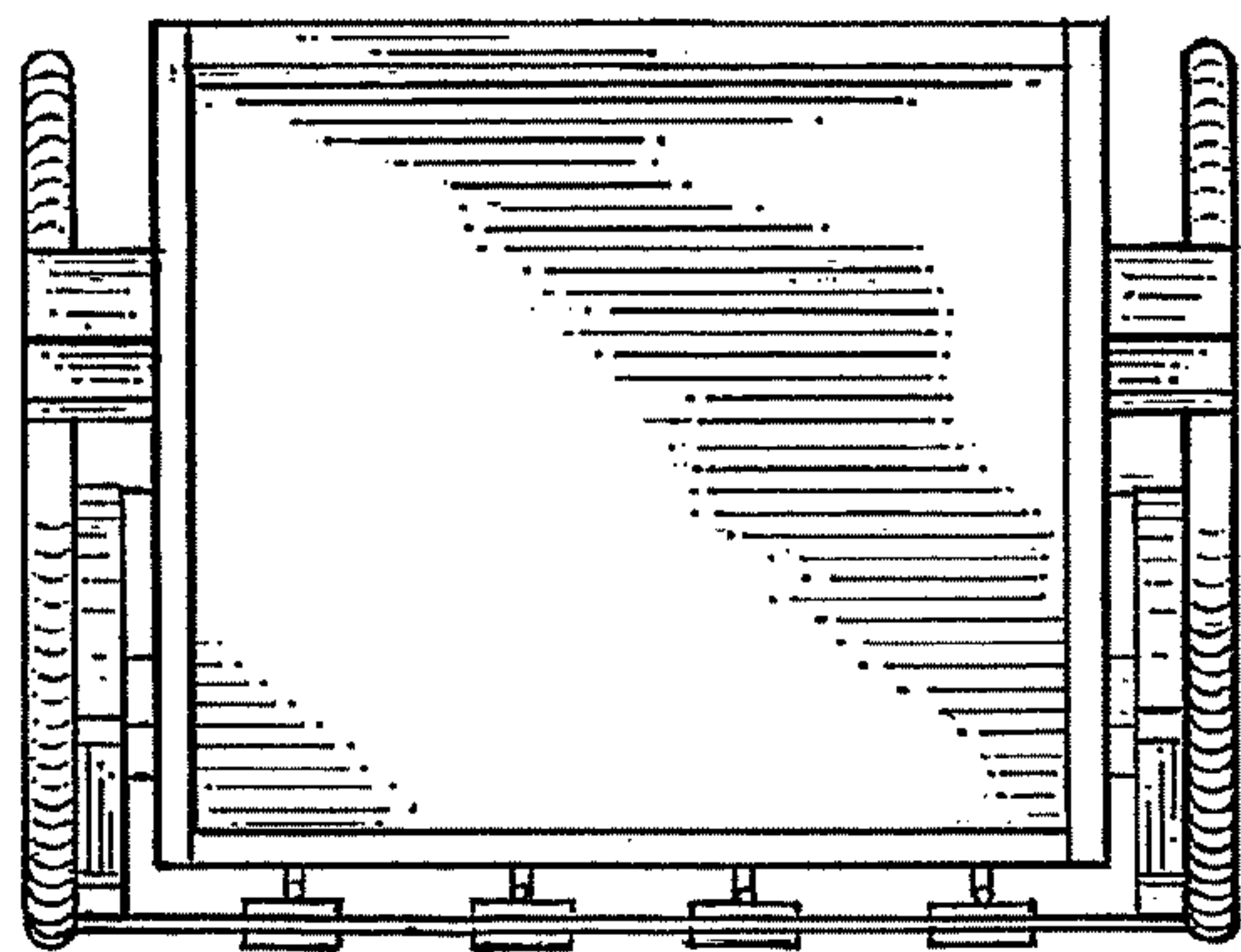
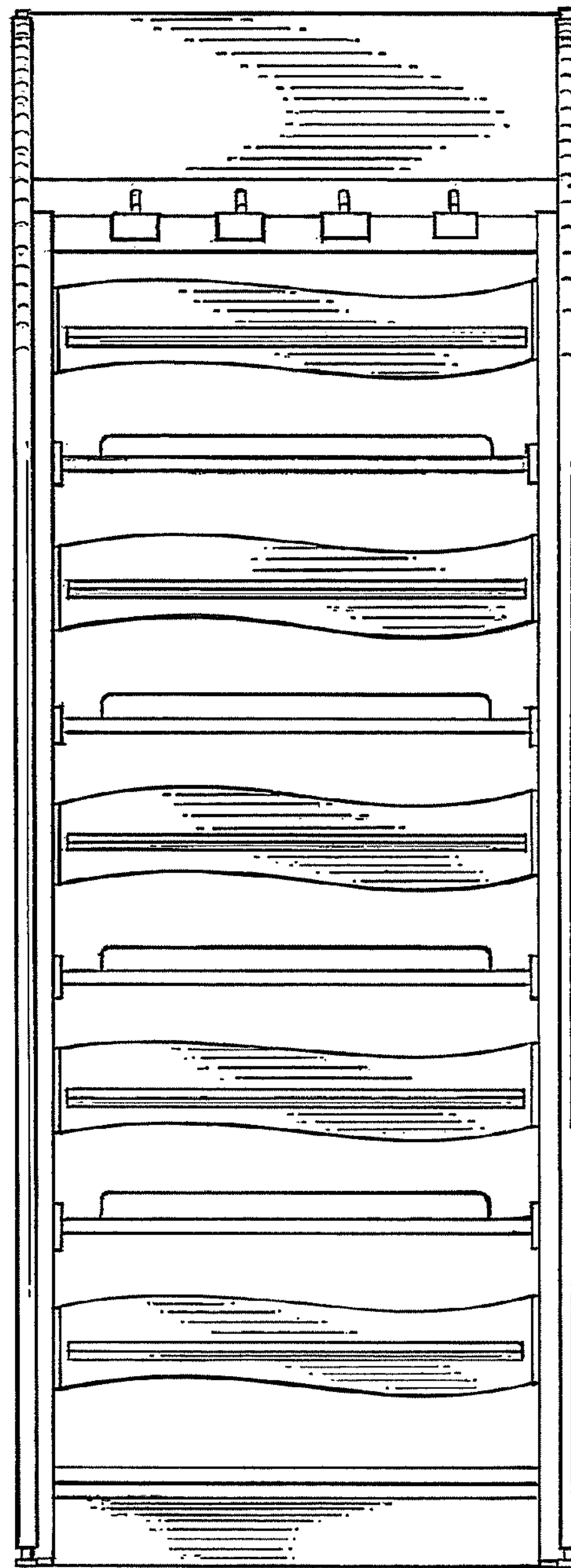

FIG.6



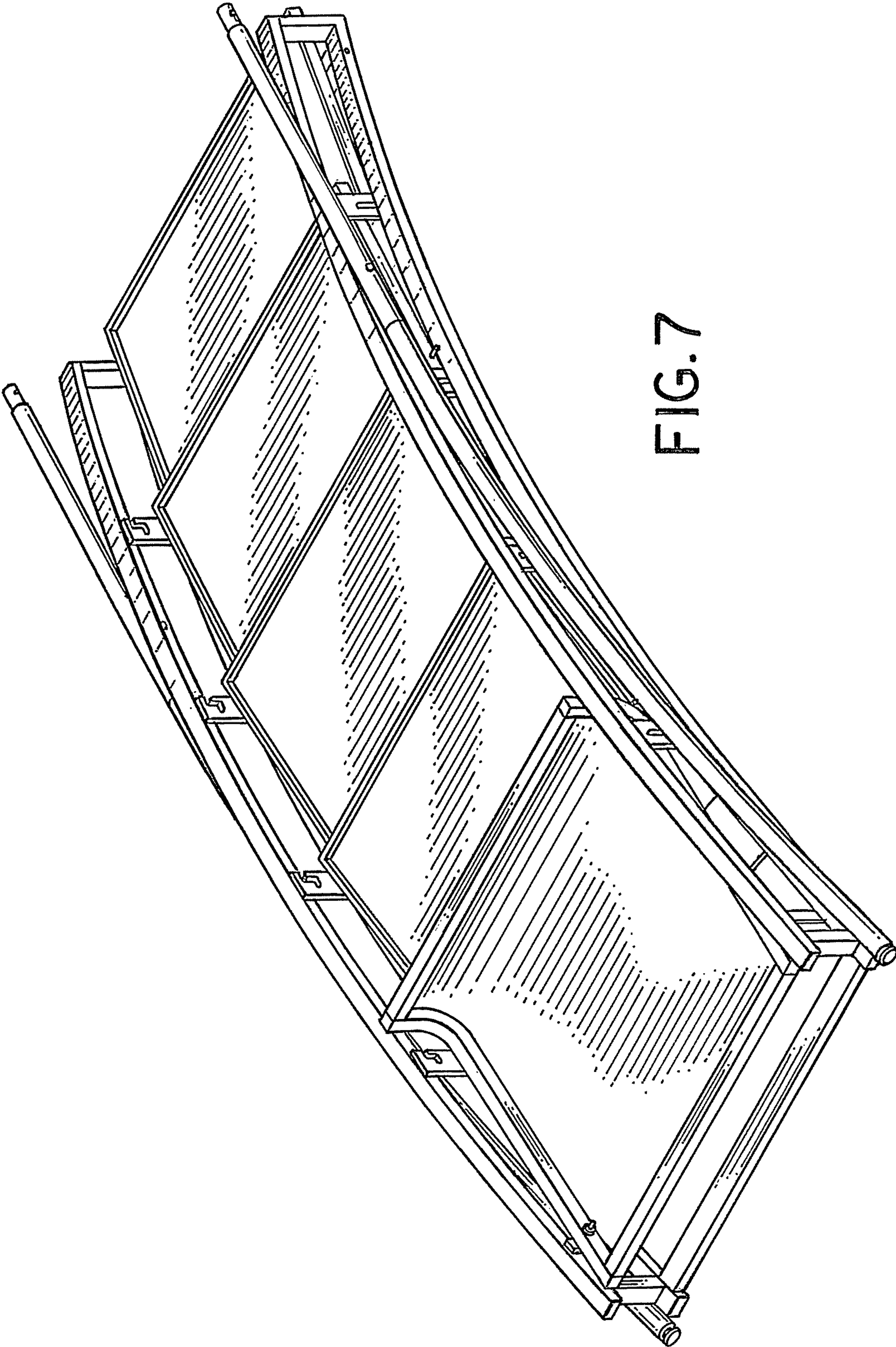

FIG. 7