



US00D716012S

(12) **United States Design Patent**
Jackson et al.

(10) **Patent No.:** **US D716,012 S**
(45) **Date of Patent:** **** Oct. 21, 2014**

(54) **LID FOR CONTAINER**

(74) *Attorney, Agent, or Firm* — Osha Liang LLP

(71) Applicant: **Pailpac Proprietary Limited**, New Germany (ZA)

(57) **CLAIM**
The ornamental design for a lid for container, as shown and described.

(72) Inventors: **Gavin Wayne Jackson**, Alverstone (ZA); **Theodorus Daniel Moolman**, Salt Rock (ZA)

DESCRIPTION

(73) Assignee: **Pailpac Proprietary Limited**, New Germany (ZA)

FIG. 1 is a top perspective view of a lid for container incorporating our ornamental design;
FIG. 2 is a front view of the lid for container incorporating our ornamental design;
FIG. 3 is a rear view of the lid for container incorporating our ornamental design;
FIG. 4 is a side view of the lid for container incorporating our ornamental design;
FIG. 5 is an opposite side view of the lid for container incorporating our ornamental design;
FIG. 6 is a top view of the lid for container incorporating our ornamental design;
FIG. 7 is a top perspective view of a lid for container incorporating an alternative embodiment of our ornamental design;

(**) Term: **14 Years**

(21) Appl. No.: **29/464,028**

(22) Filed: **Aug. 12, 2013**

(30) **Foreign Application Priority Data**

Feb. 12, 2013 (ZA) A2013/00298
Feb. 12, 2013 (ZA) A2013/00299

FIG. 8 is a front view of the lid for container of FIG. 7;
FIG. 9 is a rear view of the lid for container of FIG. 7;
FIG. 10 is a side view of the lid for container of FIG. 7;
FIG. 11 is an opposite side view of the lid for container of FIG. 7;
FIG. 12 is a top view of the lid for container of FIG. 7;
FIG. 13 is a top perspective view of the lid for container incorporating an alternative embodiment of our ornamental design;
FIG. 14 is a front view of the lid for container of FIG. 13;
FIG. 15 is a rear view of the lid for container of FIG. 13;
FIG. 16 is a side view of the lid for container of FIG. 13;
FIG. 17 is an opposite side view of the lid for container of FIG. 13; and,
FIG. 18 is a top view of the lid for container of FIG. 13.

(51) **LOC (10) Cl.** **07-07**

(52) **U.S. Cl.**
USPC **D32/54**

(58) **Field of Classification Search**
CPC B65D 1/42; B65D 41/56; B65D 41/48
USPC D32/53, 54, 53.1; 220/796, 805, 359.2, 220/694, 200, 659; D34/10
See application file for complete search history.

(56) **References Cited**

U.S. PATENT DOCUMENTS

5,743,425 A * 4/1998 Ellis 220/254.2
6,142,332 A * 11/2000 Ferrara 220/212
D659,333 S * 5/2012 Morris, Jr. D32/54

The broken line showing of a cap and vent holes is included for the purpose of illustrating environmental structure and forms no part of the claimed design.

Primary Examiner — Robin V Webster

1 Claim, 12 Drawing Sheets

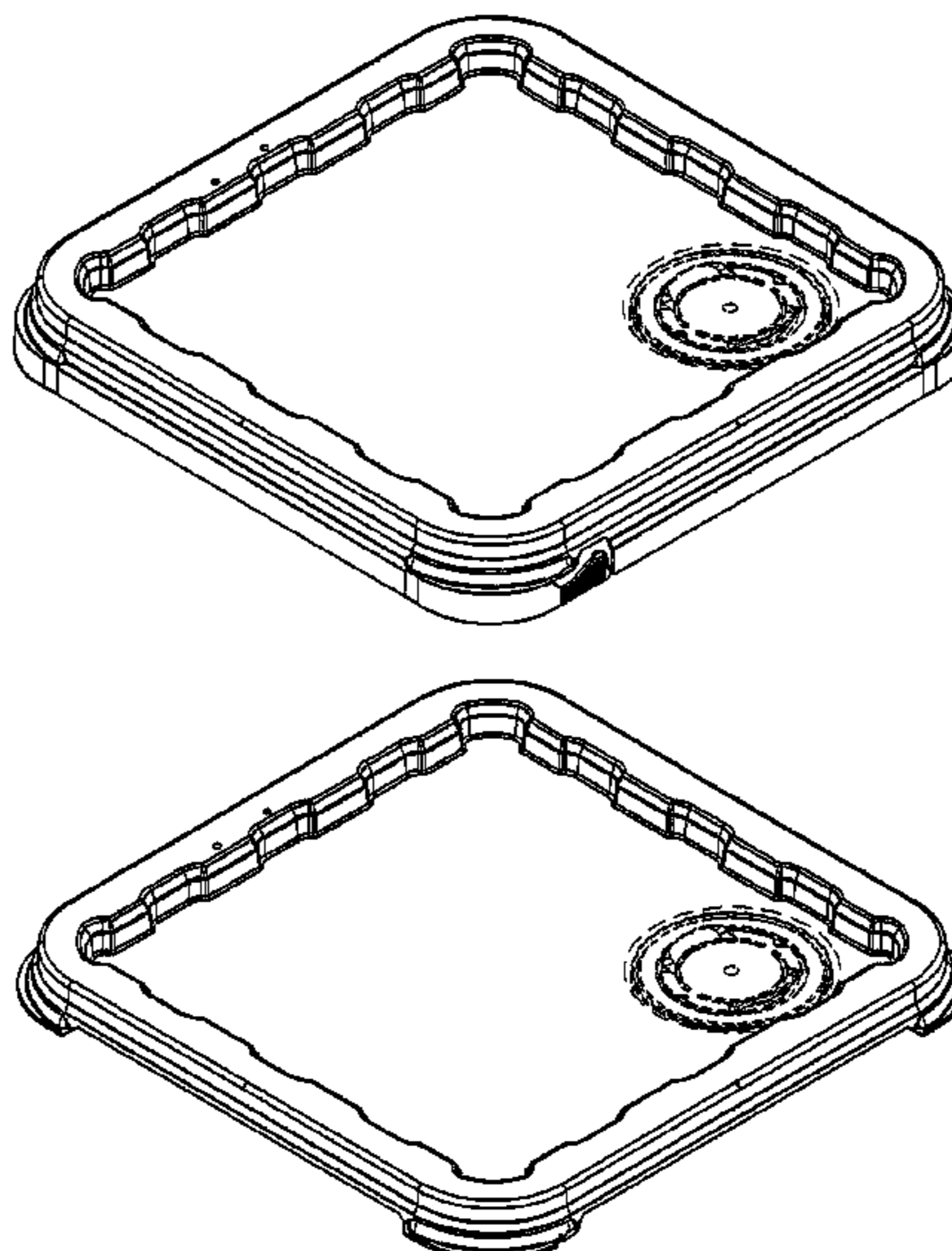

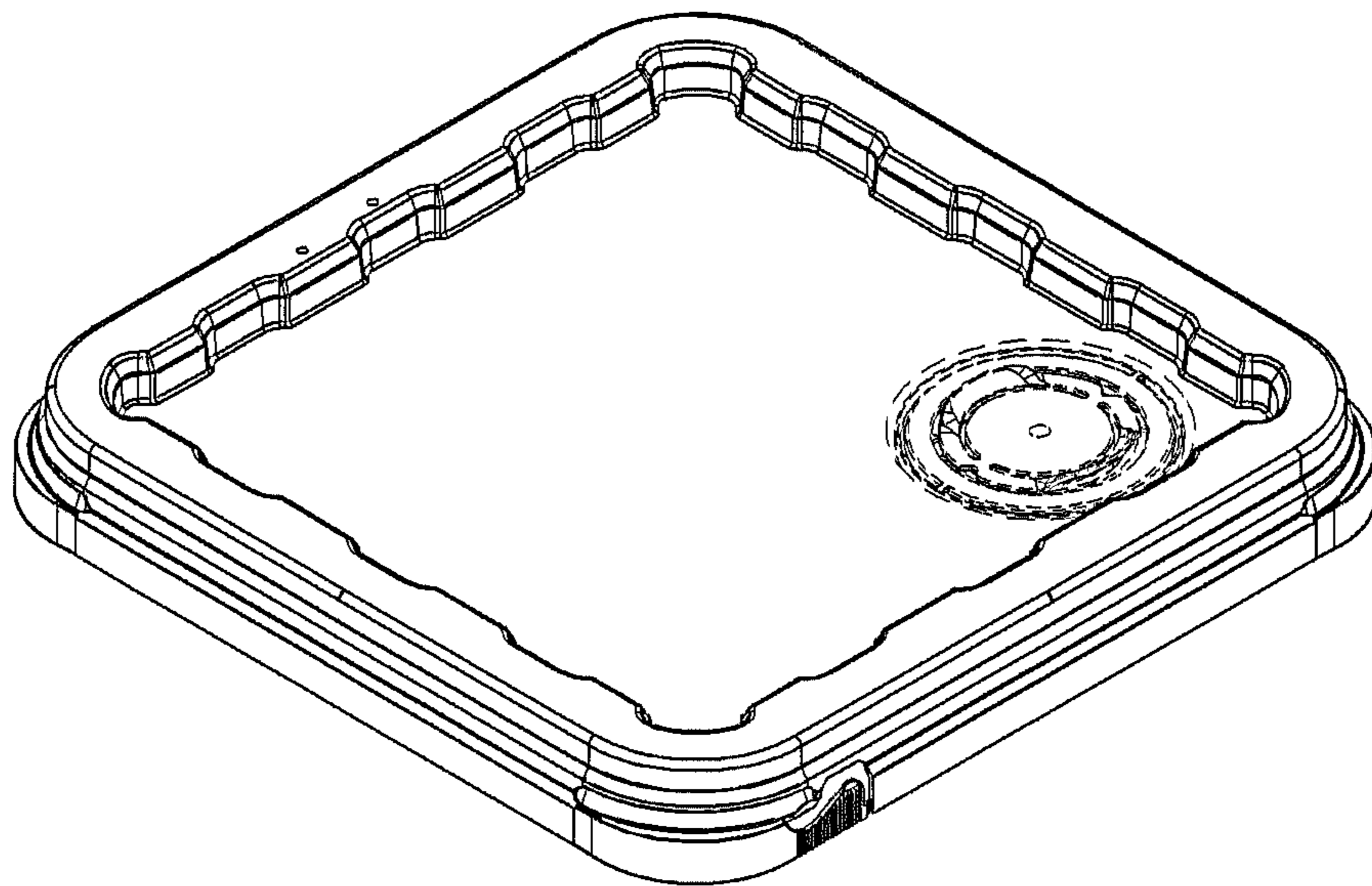

FIG 1

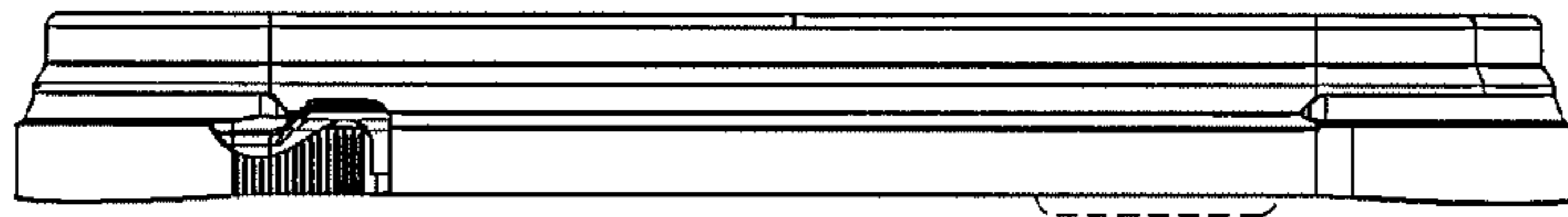

FIG 2

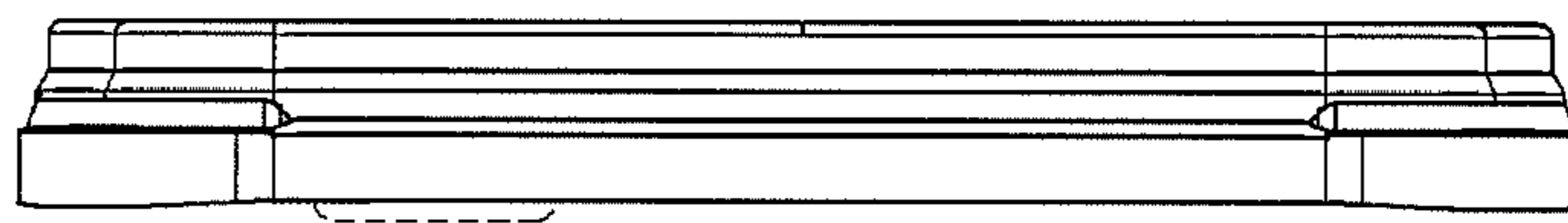

FIG 3

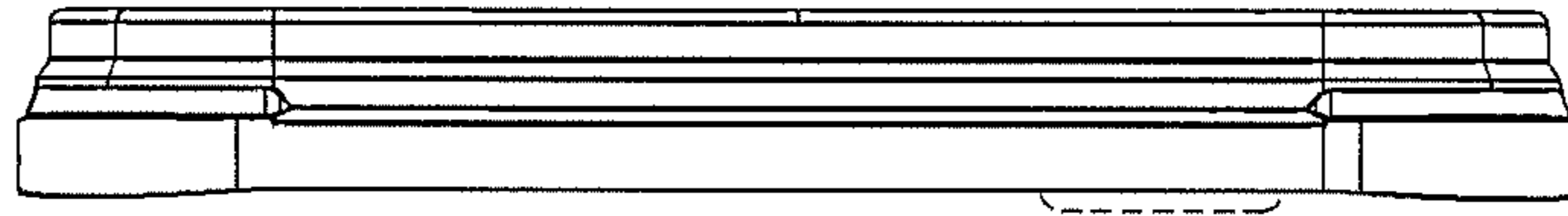

FIG 4

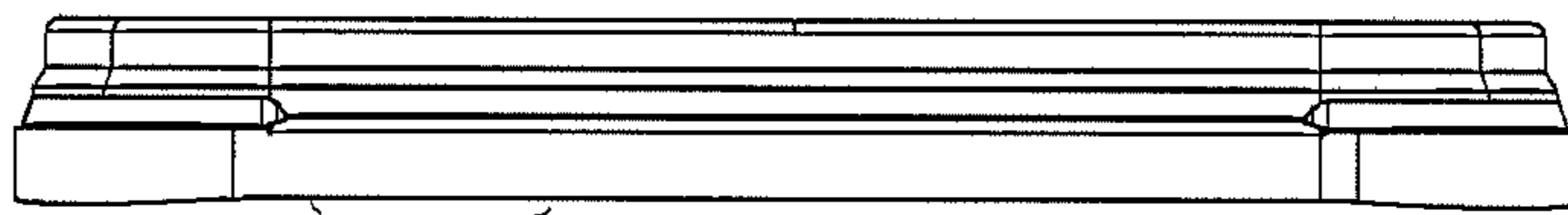

FIG 5

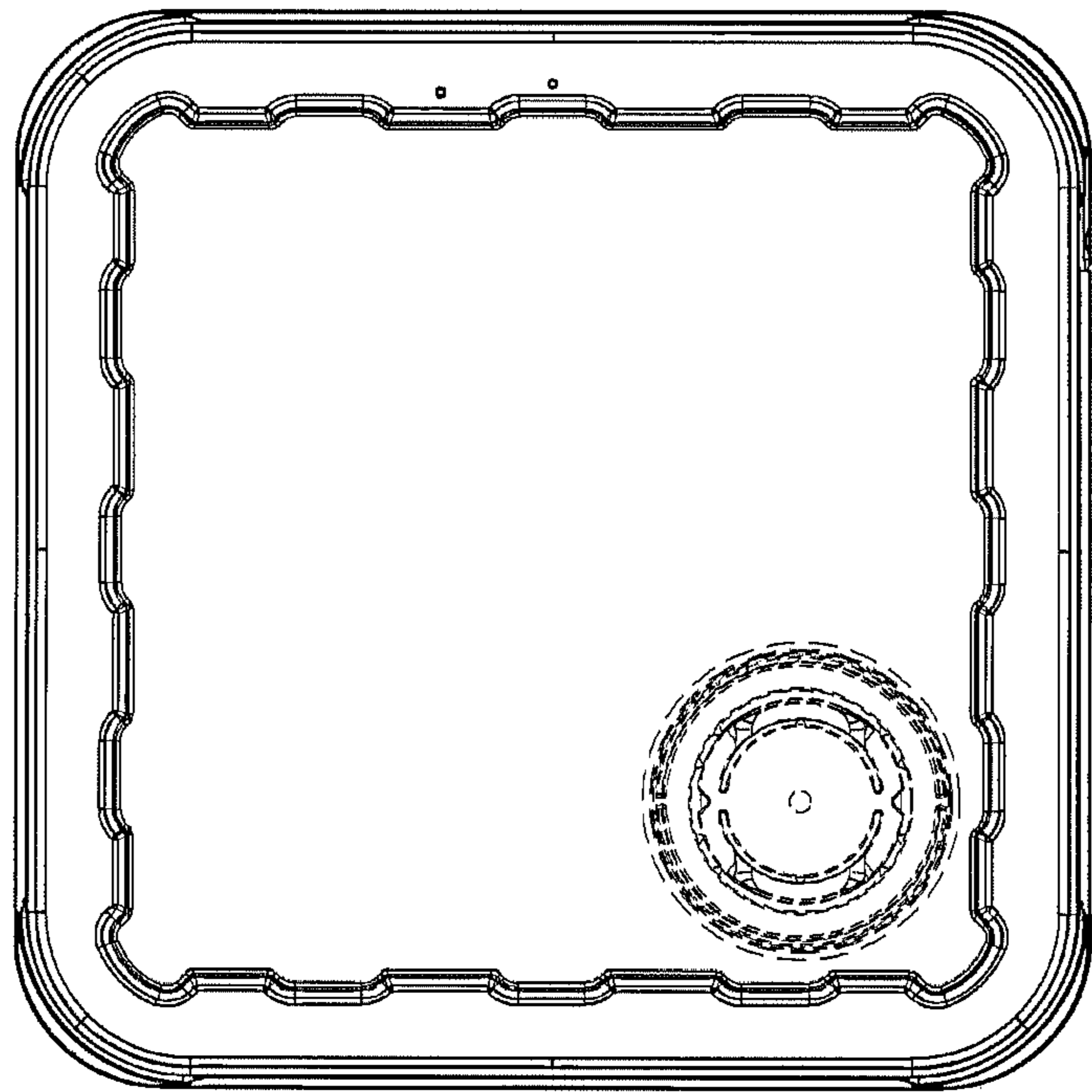

FIG 6

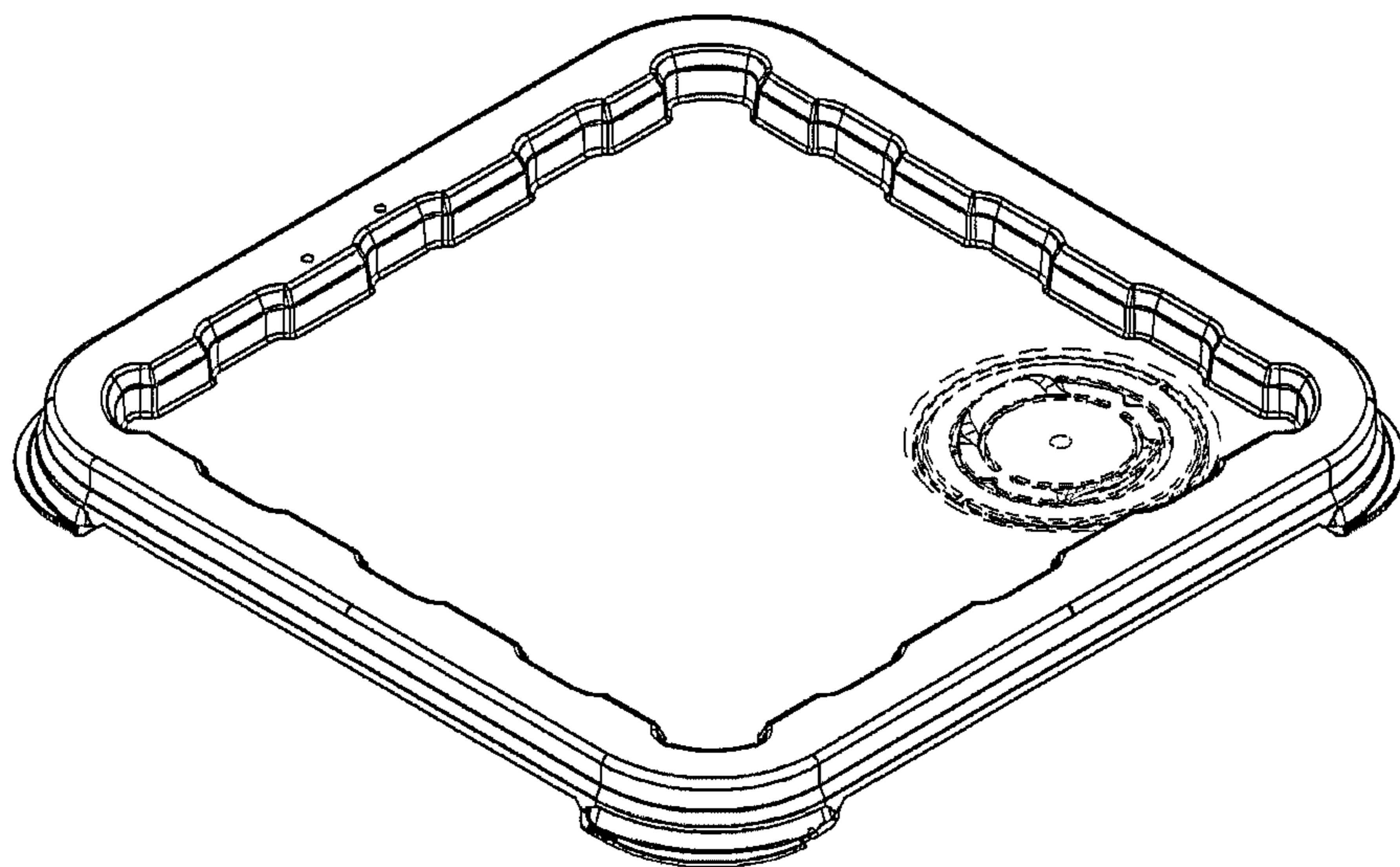

FIG 7

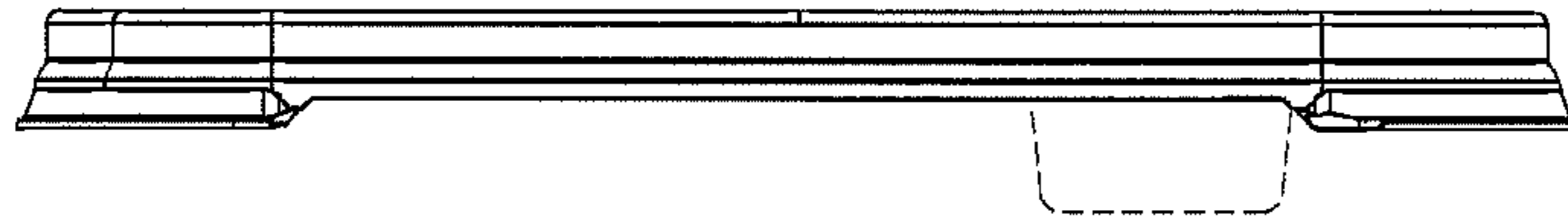

FIG 8

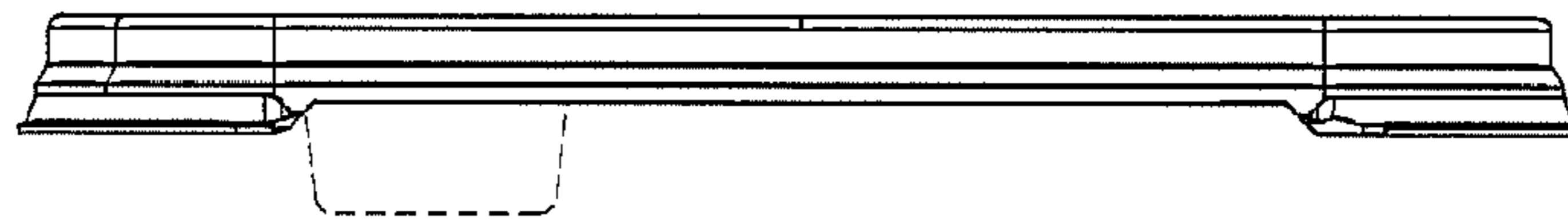

FIG 9

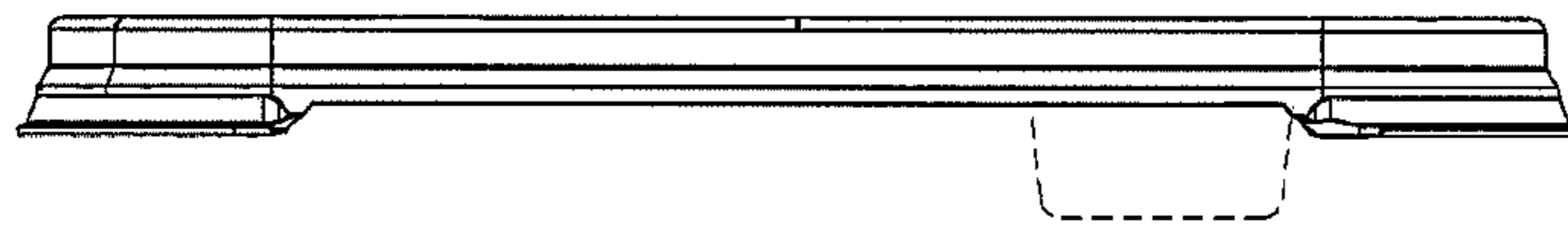

FIG 10

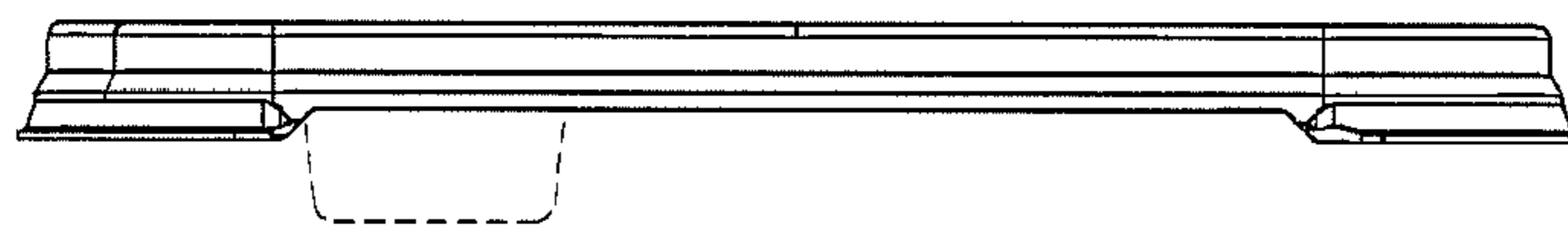

FIG 11

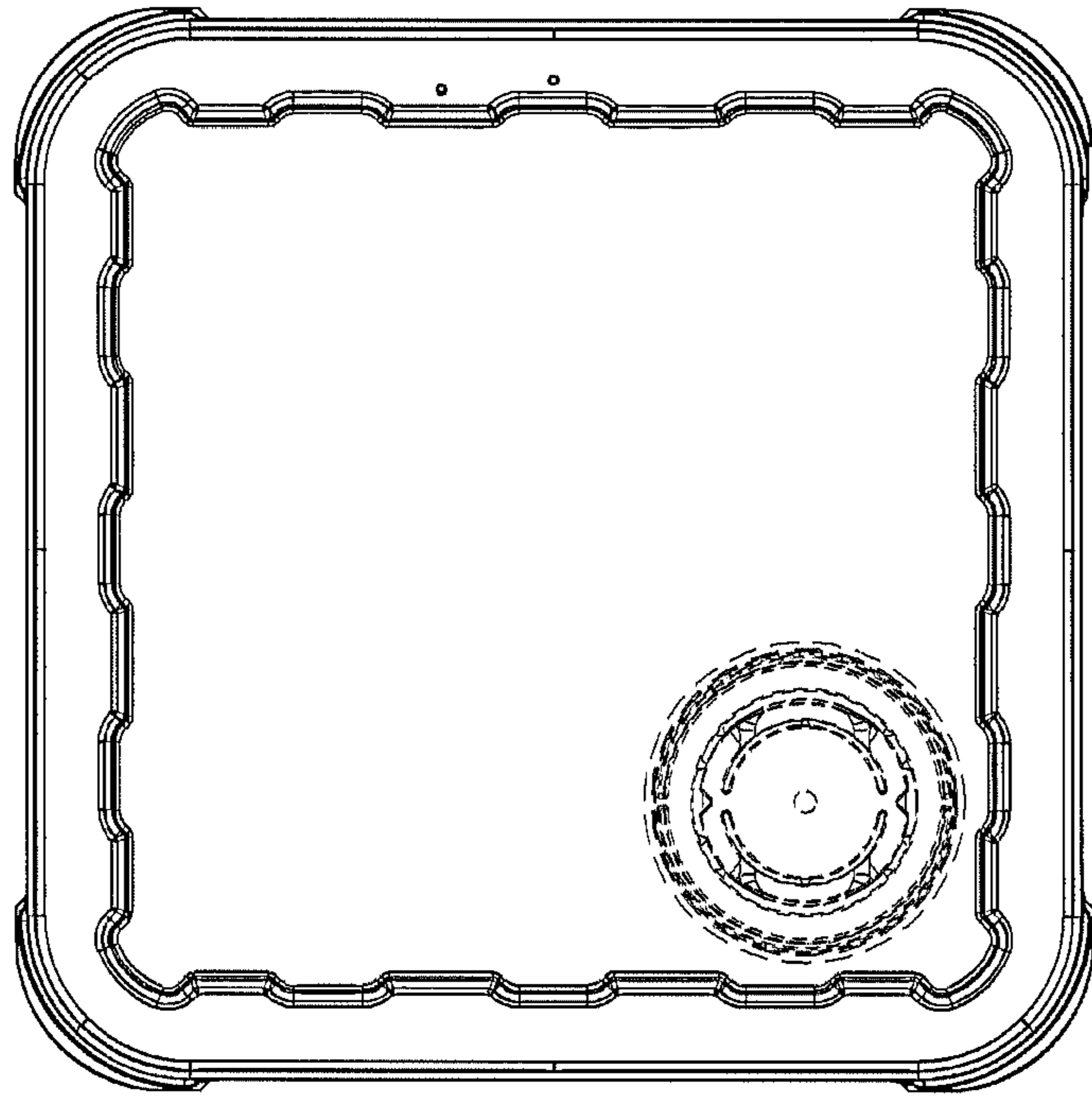

FIG 12

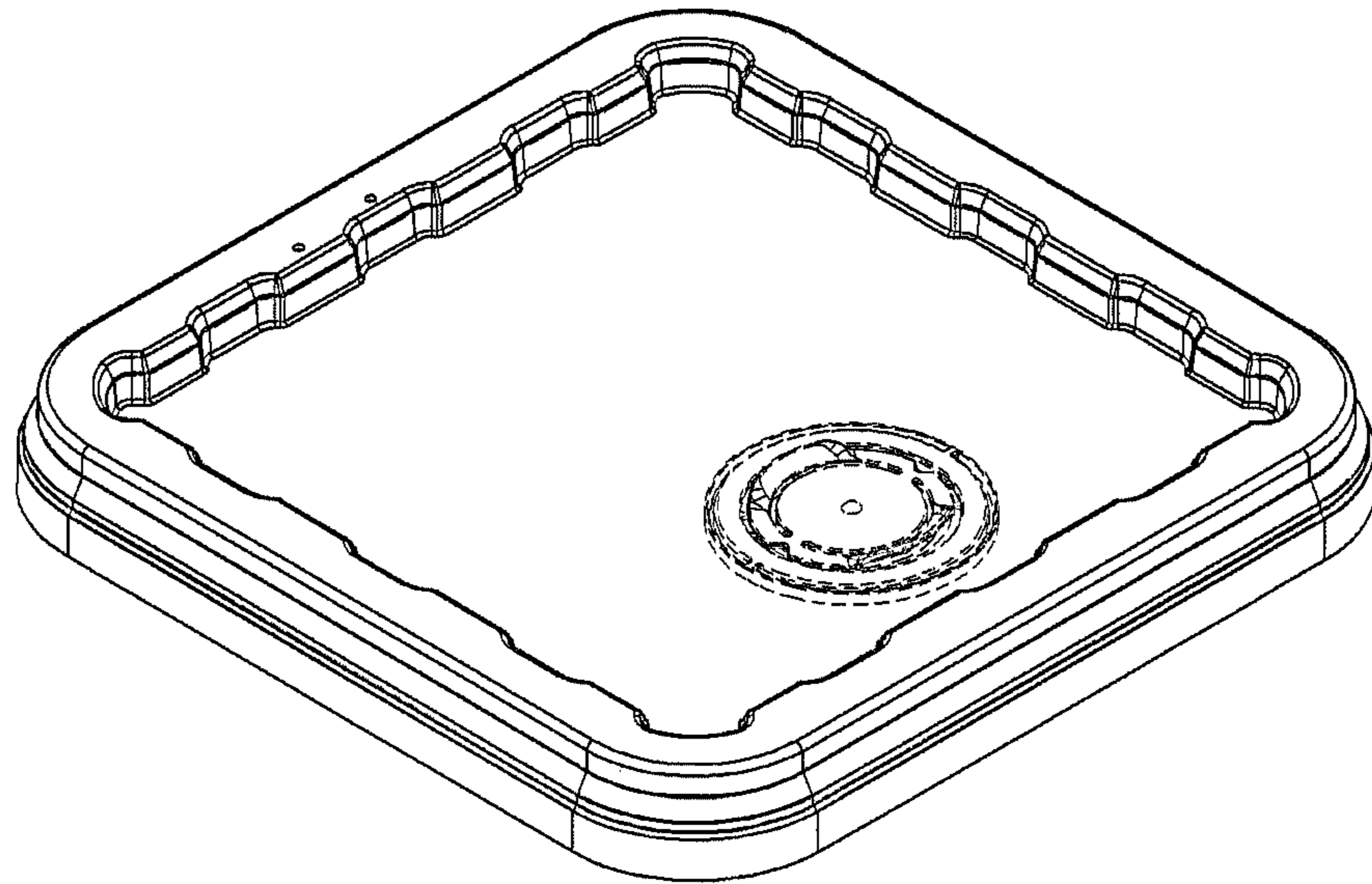

FIG 13

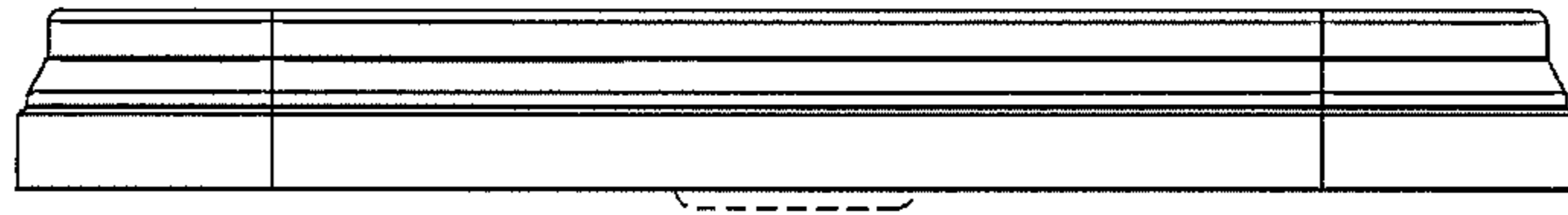

FIG 14

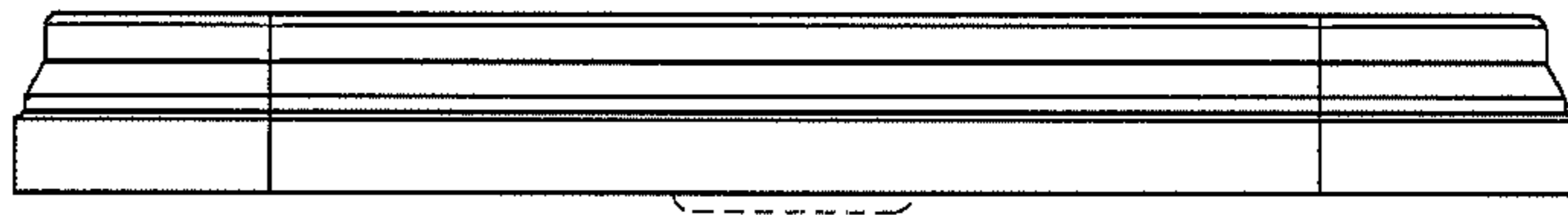

FIG 15

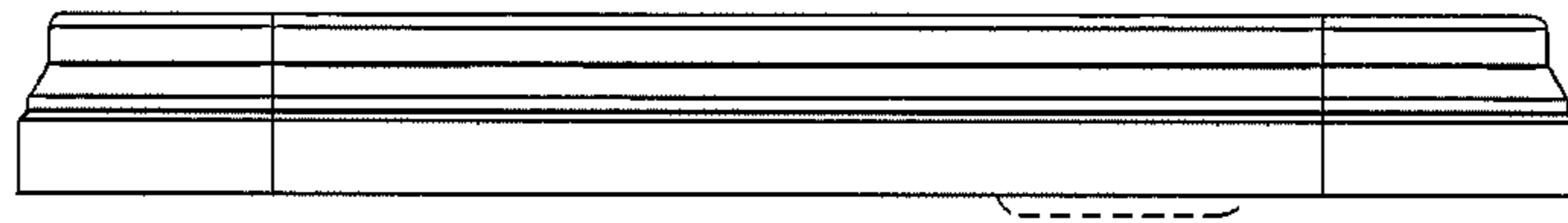

FIG 16

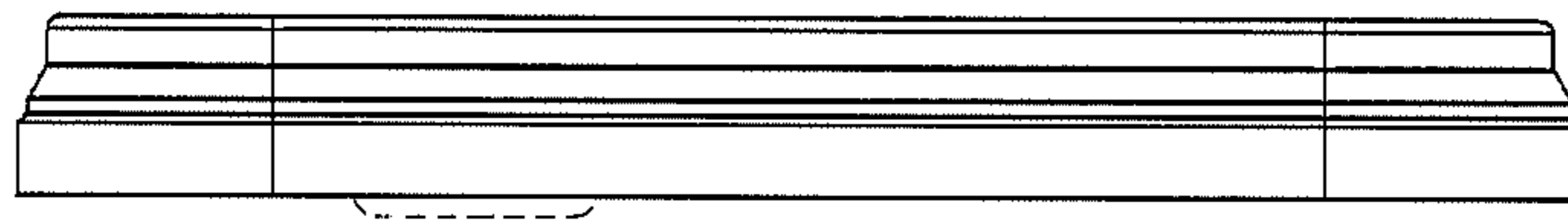

FIG 17

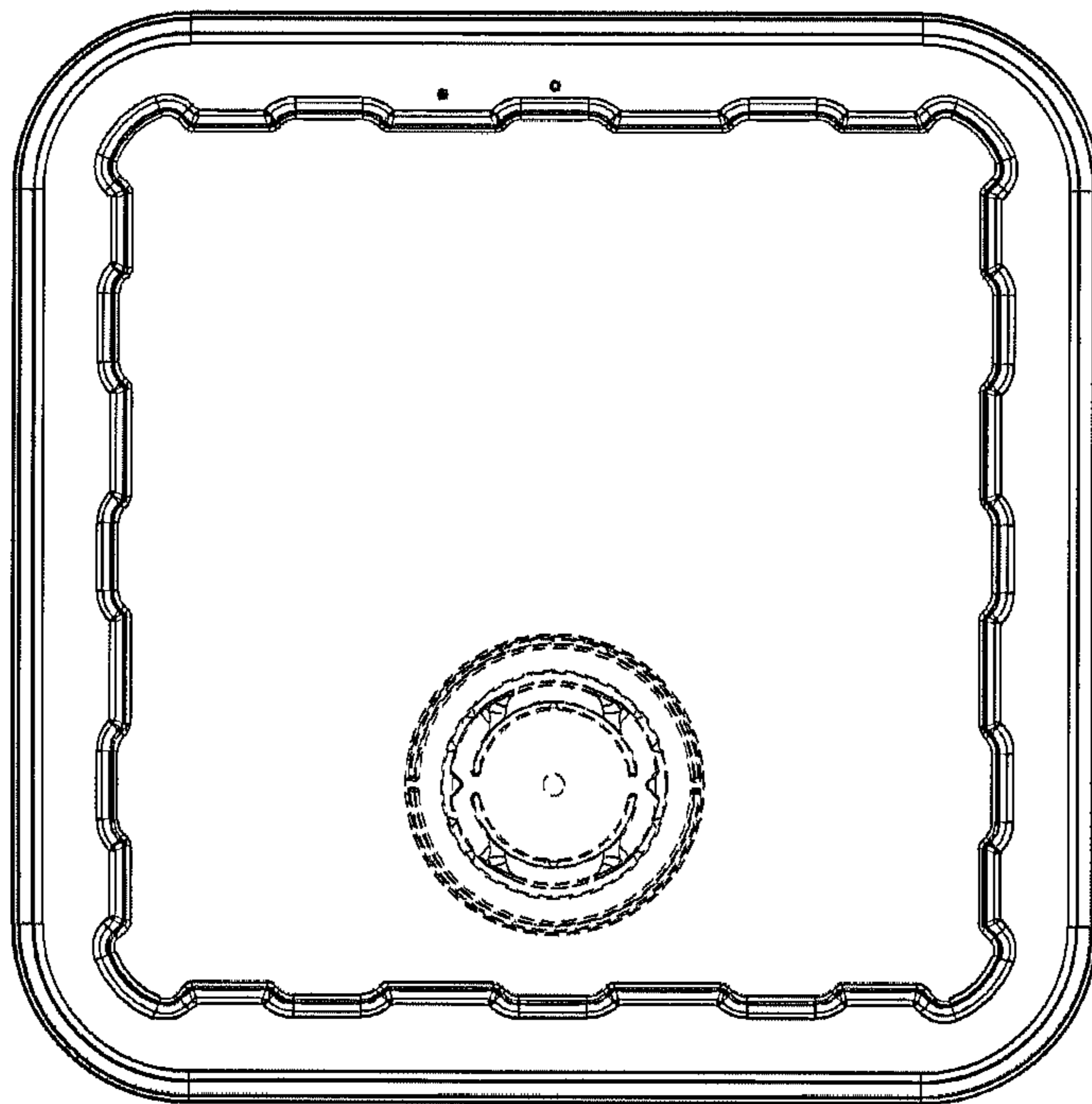

FIG 18