

US00D715936S

(12) **United States Design Patent**
Darian

(10) **Patent No.:** **US D715,936 S**
(45) **Date of Patent:** **** Oct. 21, 2014**

- (54) **ULTRASONIC OSTEOTOME**
- (71) Applicant: **Misonix, Incorporated**, Farmingdale, NY (US)
- (72) Inventor: **Alexander Darian**, Brightwaters, NY (US)
- (73) Assignee: **Misonix, Incorporated**, Farmingdale, NY (US)
- (**) Term: **14 Years**
- (21) Appl. No.: **29/468,789**
- (22) Filed: **Oct. 3, 2013**

| | | | | |
|--------------|------|---------|----------------|---------|
| 6,379,371 | B1 * | 4/2002 | Novak et al. | 606/169 |
| 6,423,082 | B1 | 7/2002 | Houser et al. | |
| 6,443,969 | B1 | 9/2002 | Novak et al. | |
| 7,217,270 | B2 | 5/2007 | Clement et al. | |
| D667,117 | S | 9/2012 | Darian et al. | |
| 8,343,178 | B2 * | 1/2013 | Novak et al. | 606/169 |
| D680,218 | S * | 4/2013 | Darian et al. | D24/144 |
| 2003/0204199 | A1 * | 10/2003 | Novak et al. | 606/169 |
| 2005/0234484 | A1 | 10/2005 | Houser et al. | |
| 2005/0273127 | A1 | 12/2005 | Novak et al. | |
| 2008/0188878 | A1 * | 8/2008 | Young | 606/169 |
| 2010/0057118 | A1 | 3/2010 | Dietz et al. | |
| 2010/0089405 | A1 | 4/2010 | Johnson et al. | |
| 2013/0090660 | A1 * | 4/2013 | Darian | 606/84 |

* cited by examiner

Primary Examiner — Wan Laymon

(74) *Attorney, Agent, or Firm* — R. Neil Sudol; Henry D. Coleman

Related U.S. Application Data

- (62) Division of application No. 29/403,580, filed on Oct. 7, 2011, now Pat. No. Des. 700,327.
- (51) **LOC (10) Cl.** **24-02**
- (52) **U.S. Cl.**
USPC **D24/146; D24/144**
- (58) **Field of Classification Search**
USPC D24/144, 146–147, 170; D8/20, 26, 98;
606/1, 39, 45, 53, 83–85, 86 R, 79, 167,
606/169–171
See application file for complete search history.

(57) **CLAIM**

The ornamental design for the ultrasonic osteotome, as shown and described.

DESCRIPTION

FIG. 1 is a top, front, and left side perspective view of an ultrasonic osteotome in accordance with the present invention;
 FIG. 2 is a left-side elevational view thereof, the right side elevation being a mirror image;
 FIG. 3 is a top plan view thereof;
 FIG. 4 is a bottom plan view thereof;
 FIG. 5 is a front elevational view thereof; and,
 FIG. 6 is a rear elevational view thereof.
 The broken lines in FIG. 6 are included for the purpose of illustrating portions of the ultrasonic osteotome that form no part of the claimed design.

(56) **References Cited**

U.S. PATENT DOCUMENTS

| | | | | |
|-----------|-----|---------|-------------|---------|
| 5,261,922 | A | 11/1993 | Hood | |
| 5,318,570 | A | 6/1994 | Hood et al. | |
| 5,695,510 | A * | 12/1997 | Hood | 606/169 |
| 5,935,142 | A | 8/1999 | Hood | |
| 6,254,622 | B1 | 7/2001 | Hood | |

1 Claim, 1 Drawing Sheet

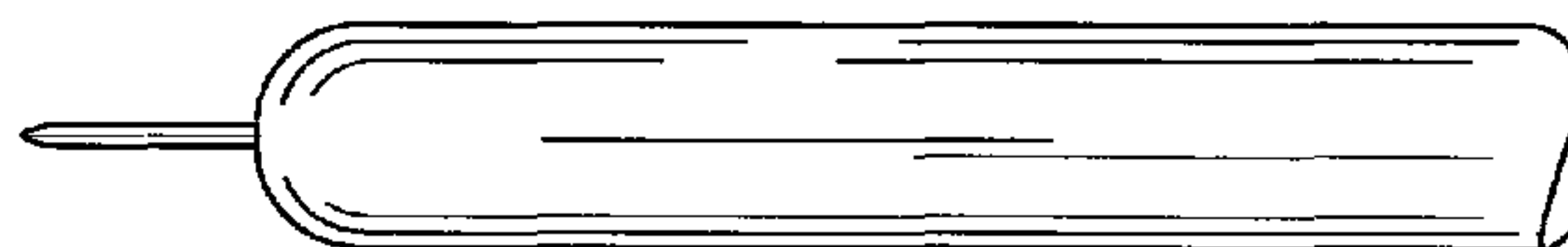
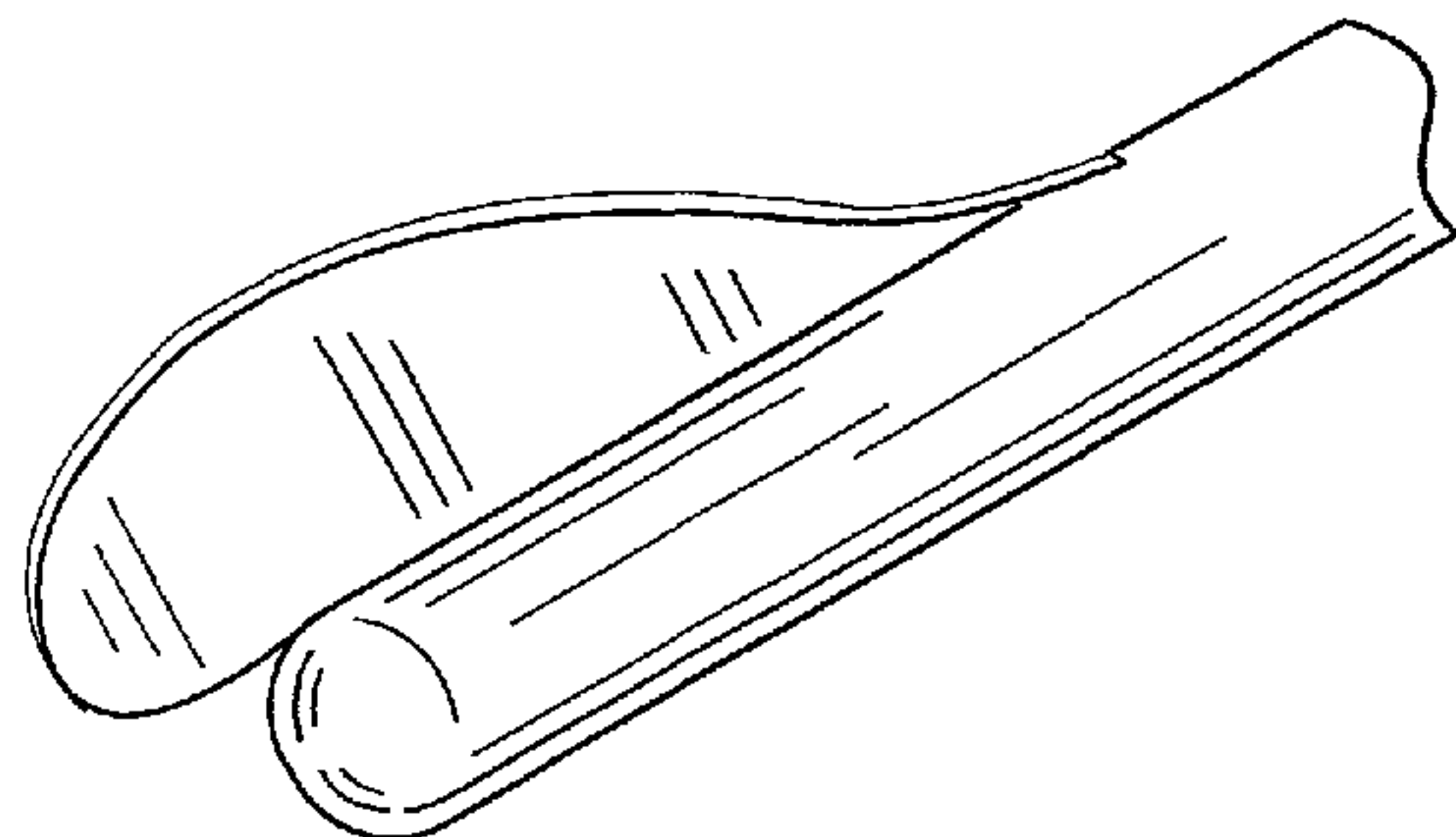

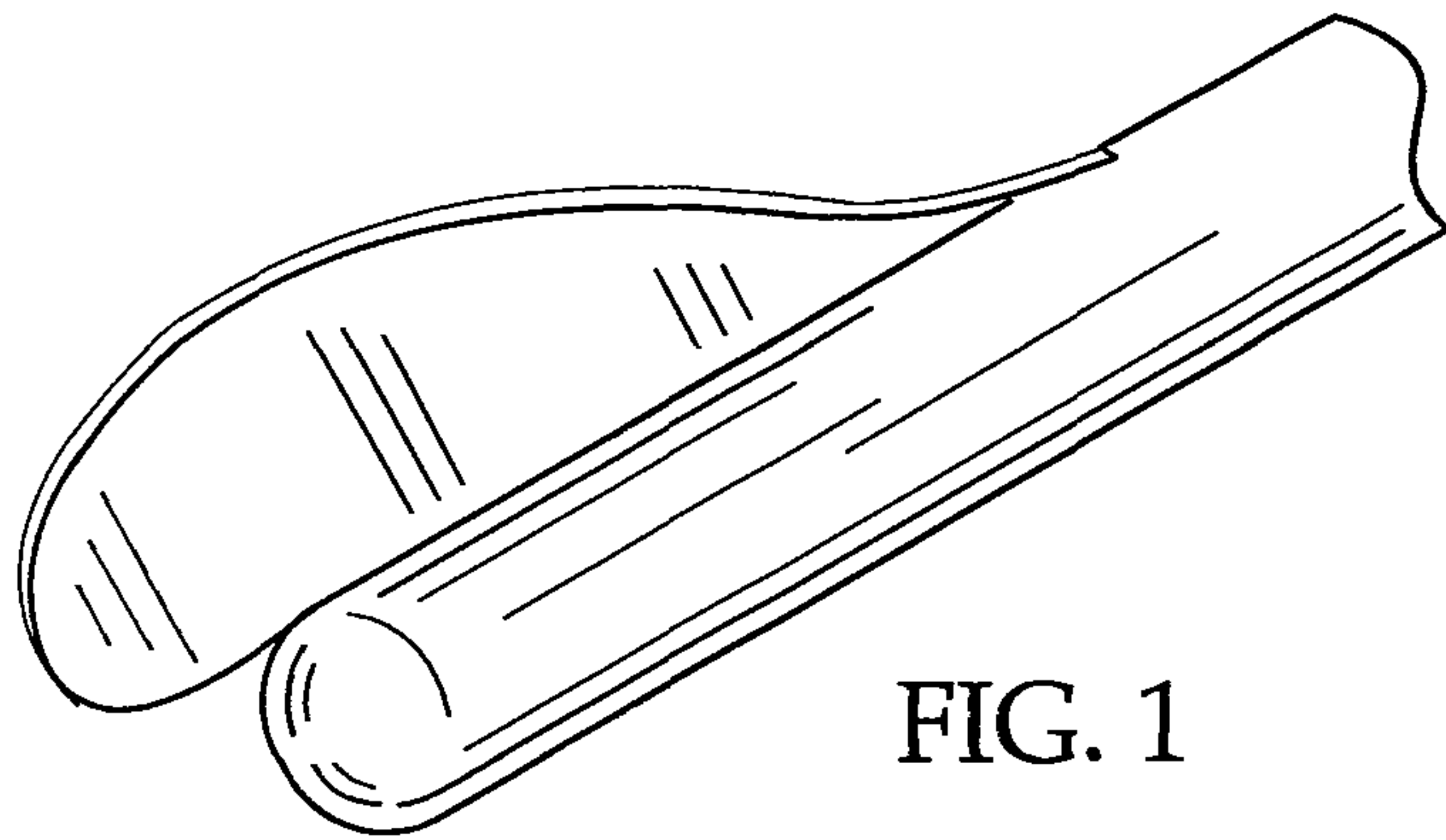

FIG. 1

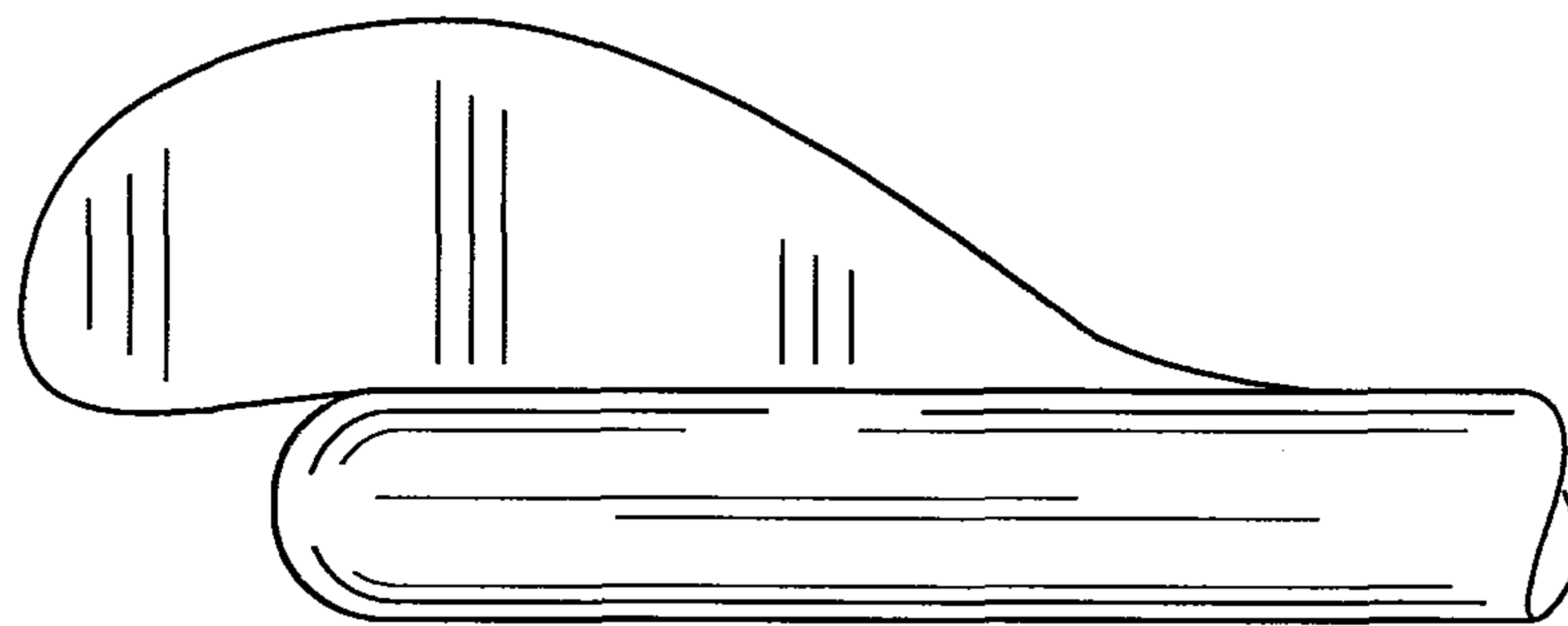

FIG. 2

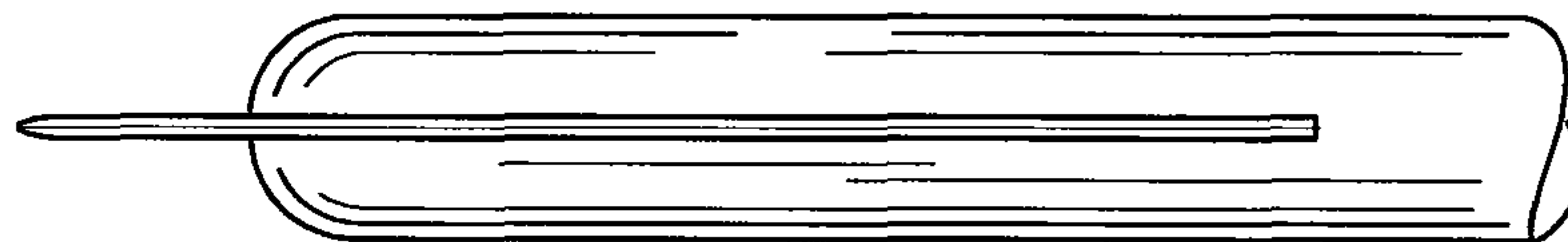

FIG. 3

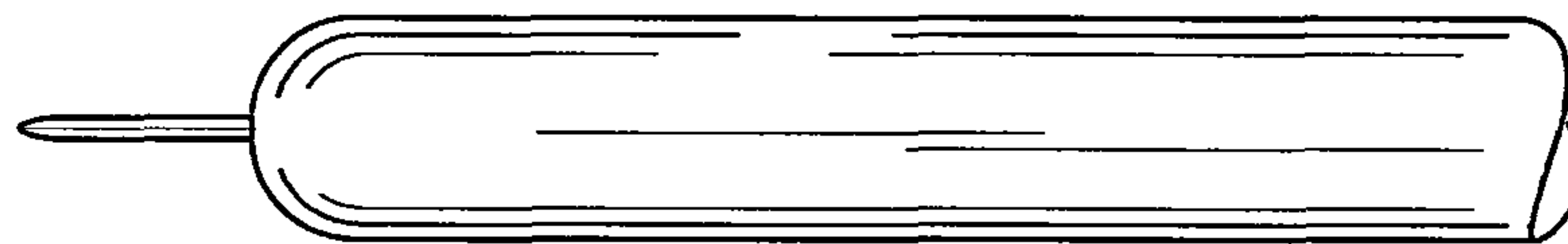

FIG. 4

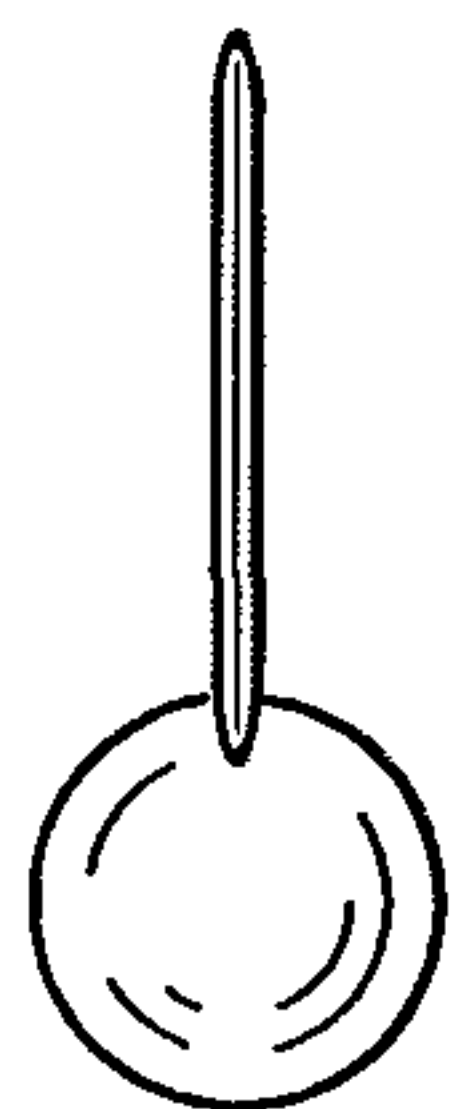

FIG. 5

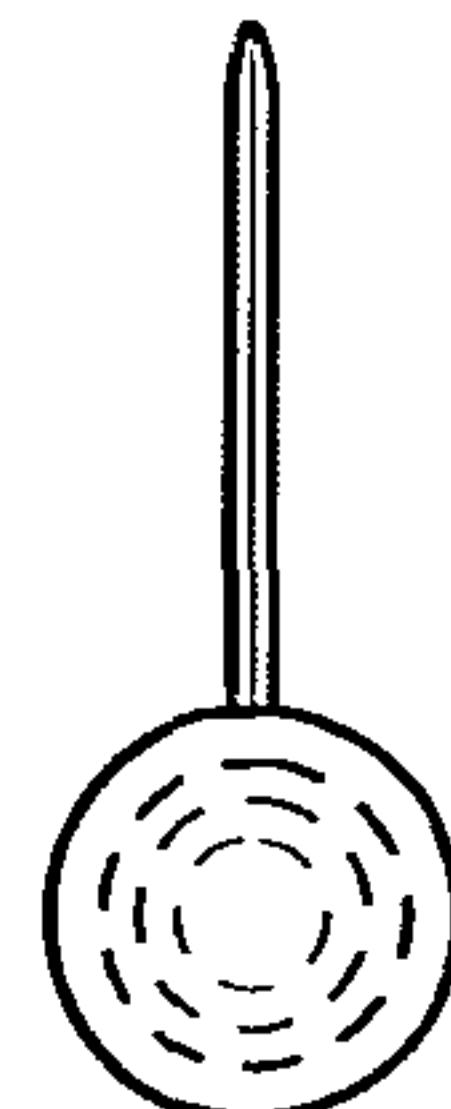

FIG. 6