



US00D715923S

(12) **United States Design Patent**  
**Cardin et al.**

(10) **Patent No.:** **US D715,923 S**

(45) **Date of Patent:** **\*\* Oct. 21, 2014**

(54) **SANITARY NAPKIN**

(75) Inventors: **Jeannine Cardin**, St-Eugène (CA);  
**Helmut Georgi**, Drummondville (CA)

(73) Assignee: **Fempro I Inc.** (CA)

(\*\*) Term: **14 Years**

(21) Appl. No.: **29/425,362**

(22) Filed: **Jun. 21, 2012**

(51) **LOC (10) Cl.** ..... **24-04**

(52) **U.S. Cl.**  
USPC ..... **D24/125**

(58) **Field of Classification Search**  
USPC ..... D24/124, 125, 126; 604/358, 361, 378,  
604/362, 383, 384, 385.01, 386, 387, 391;  
D5/57, 60-62  
See application file for complete search history.

(56) **References Cited**

**U.S. PATENT DOCUMENTS**

- D439,332 S \* 3/2001 Velazquez et al. .... D24/125
- D448,476 S \* 9/2001 Page et al. .... D24/124

(Continued)

*Primary Examiner* — Michael A Pratt  
*Assistant Examiner* — Michelle E Wilson

(74) *Attorney, Agent, or Firm* — St. Onge Steward Johnston  
& Reens LLC

(57) **CLAIM**

The ornamental design for a sanitary napkin, as shown and described.

**DESCRIPTION**

FIG. 1 is a top plan view of the sanitary napkin according to the first variant;

FIG. 2 is a bottom plan view thereof;

FIG. 3 is a front view thereof, the rear view being identical;

FIG. 4 is a side view thereof, the other side view being a mirror image thereof;

FIG. 5 is a top plan view of the sanitary napkin according to the second variant;

FIG. 6 is a bottom plan view thereof;

FIG. 7 is a front view thereof, the rear view being identical;

FIG. 8 is a side view thereof, the other side view being a mirror image thereof;

FIG. 9 is a top plan view of the sanitary napkin according to the third variant;

FIG. 10 is a bottom plan view thereof;

FIG. 11 is a front view thereof, the rear view being identical;

FIG. 12 is a side view thereof, the other side view being a mirror image thereof;

FIG. 13 is a top plan view of the sanitary napkin according to the fourth variant;

FIG. 14 is a bottom plan view thereof;

FIG. 15 is a front view thereof, the rear view being identical;

FIG. 16 is a side view thereof, the other side view being mirror image thereof;

FIG. 17 is a top plan view of the sanitary napkin according to the fifth variant;

FIG. 18 is a bottom plan view thereof;

FIG. 19 is a front view thereof, the rear view being identical; and,

FIG. 20 is a side view thereof, the other side view being a mirror image thereof.

The design consists of the features of pattern and ornament of the portions of the sanitary napkin shown in solid lines in the drawings. The portions of the drawings shown in stippled lines do not form part of the claimed design.

**1 Claim, 15 Drawing Sheets**

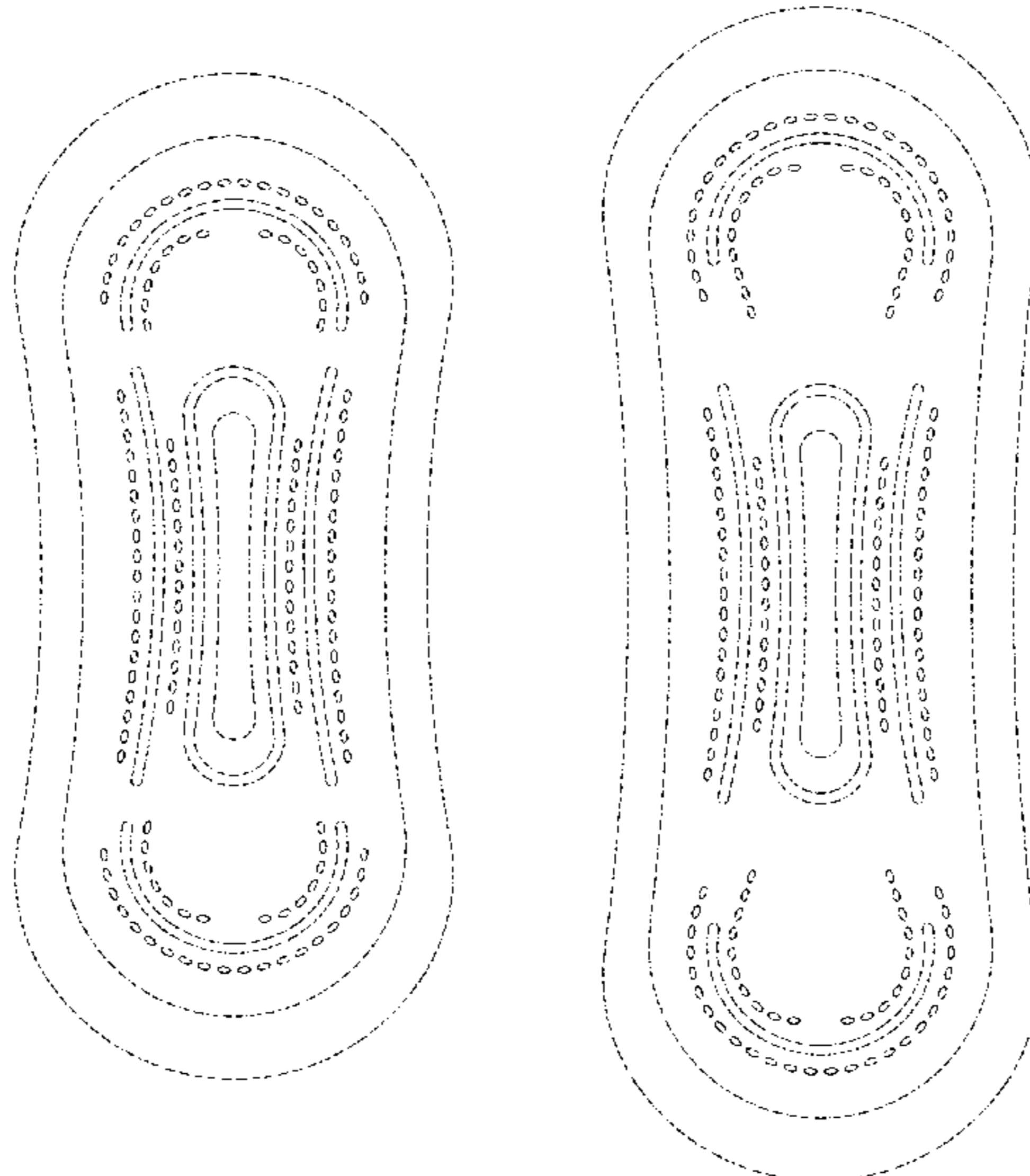

(56)

**References Cited**

U.S. PATENT DOCUMENTS

D460,176 S \* 7/2002 Carlucci et al. .... D24/125  
 D468,426 S \* 1/2003 Edens et al. .... D24/124  
 D473,940 S \* 4/2003 Hantke et al. .... D24/124  
 D475,456 S \* 6/2003 Gell ..... D24/125  
 6,590,138 B2 \* 7/2003 Onishi ..... 604/378  
 D478,661 S \* 8/2003 Levy et al. .... D24/125  
 D482,785 S \* 11/2003 Lord ..... D24/125  
 D482,786 S \* 11/2003 Harriz ..... D24/125  
 D496,100 S \* 9/2004 Ecker ..... D24/125  
 D511,001 S \* 10/2005 Christianson et al. .... D24/125  
 7,145,054 B2 \* 12/2006 Zander et al. .... 604/380  
 D542,409 S \* 5/2007 Wannaborworn et al. ... D24/125  
 D554,254 S \* 10/2007 Cole ..... D24/125

D600,805 S \* 9/2009 Hood et al. .... D24/124  
 7,589,249 B2 \* 9/2009 Gubernick et al. .... 604/378  
 7,674,949 B2 \* 3/2010 Wahlstrom et al. .... 604/380  
 7,686,790 B2 \* 3/2010 Rasmussen et al. .... 604/317  
 D614,294 S \* 4/2010 Hedbratt et al. .... D24/125  
 D614,766 S \* 4/2010 Hernandez ..... D24/125  
 D615,194 S \* 5/2010 Hedbratt et al. .... D24/125  
 7,754,940 B2 \* 7/2010 Brisebois et al. .... 604/380  
 7,842,022 B2 \* 11/2010 Vegli et al. .... 604/387  
 7,857,797 B2 \* 12/2010 Kudo et al. .... 604/385.01  
 D631,151 S \* 1/2011 Lundstrom et al. .... D24/124  
 7,994,385 B2 \* 8/2011 Hernandez ..... 604/378  
 D645,960 S \* 9/2011 Hood et al. .... D24/124  
 8,093,448 B2 \* 1/2012 De Carvalho et al. .... 604/378  
 D664,642 S \* 7/2012 Hood et al. .... D24/125  
 2013/0345656 A1 \* 12/2013 Kato et al. .... 604/375

\* cited by examiner

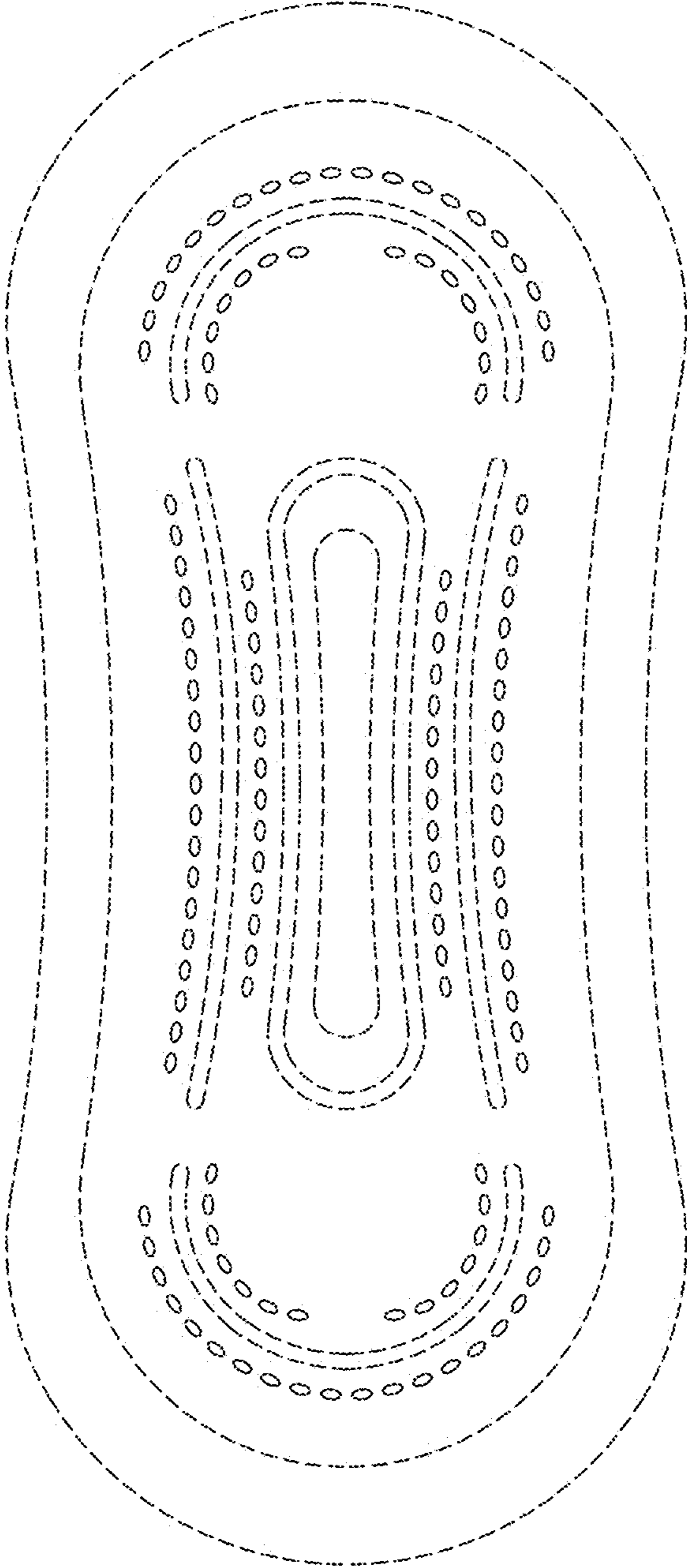

FIG. 1

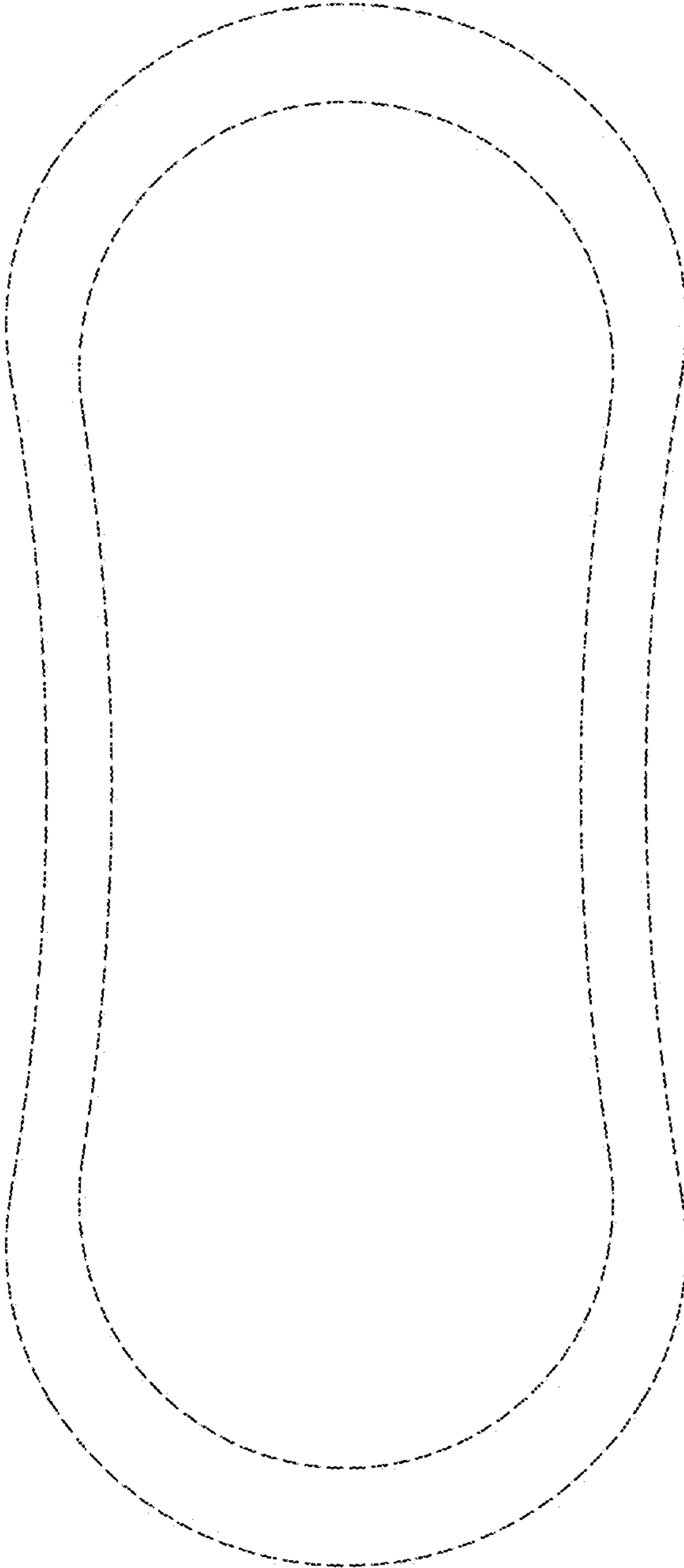

FIG. 2



FIG. 3

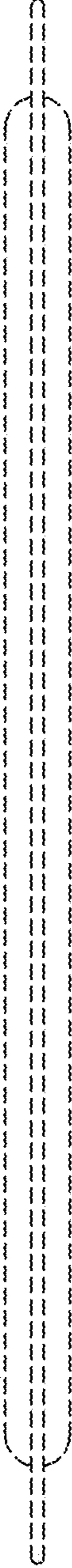

FIG. 4

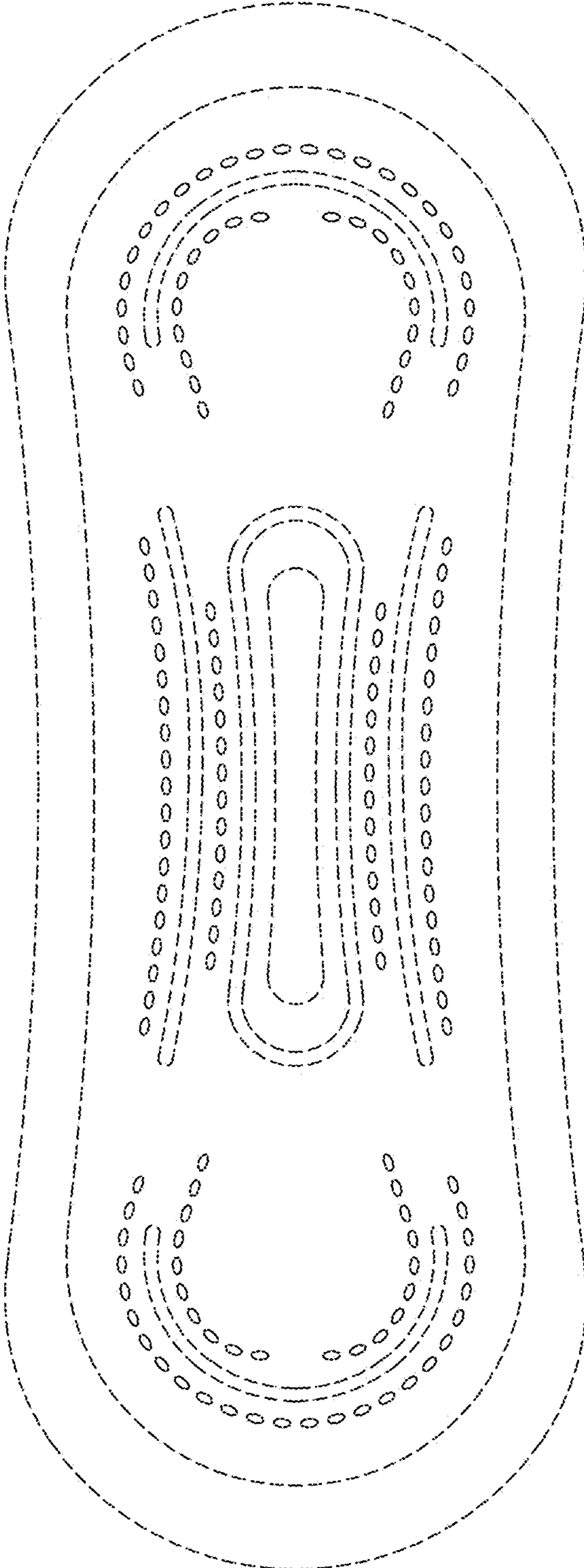

FIG. 5

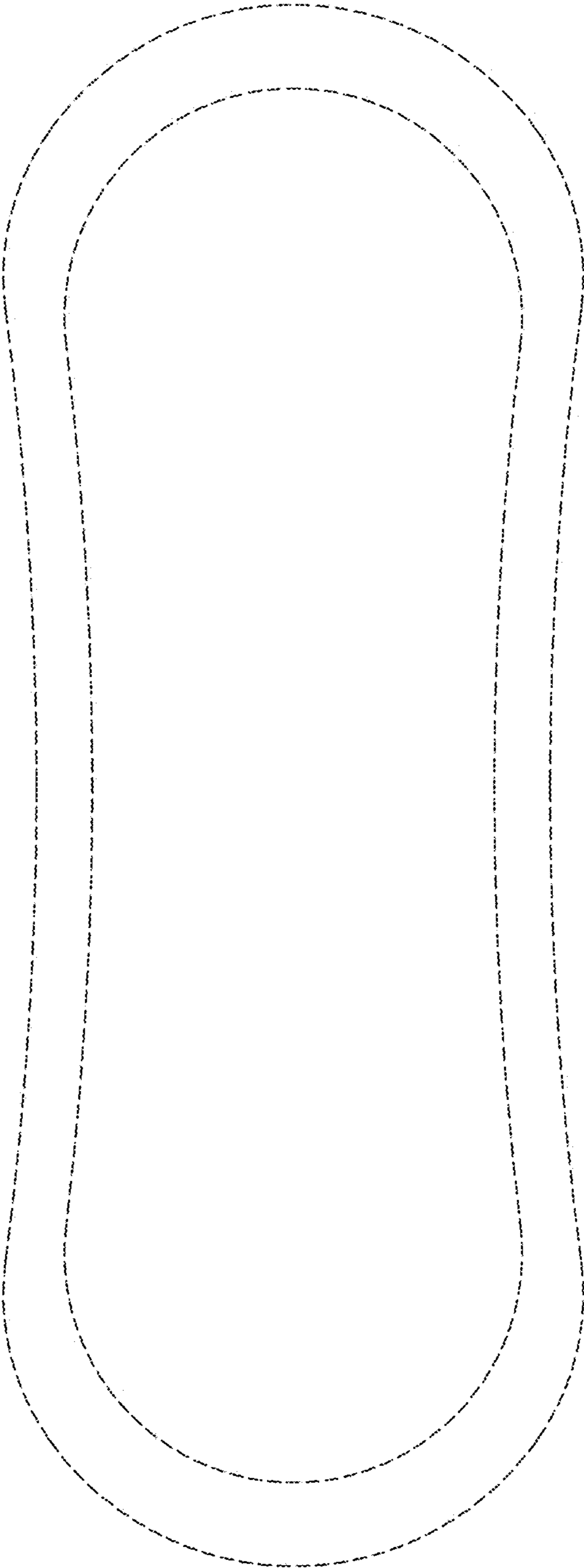

FIG. 6

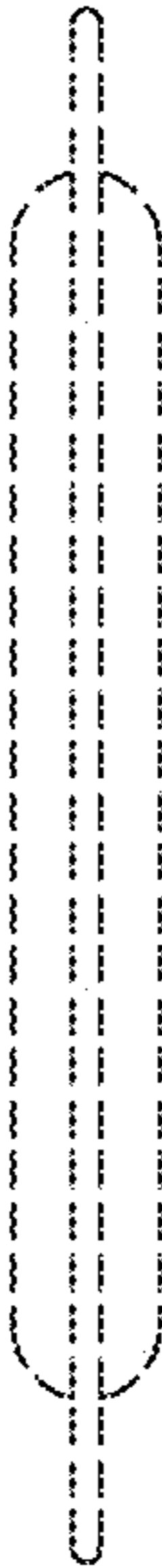

FIG. 7

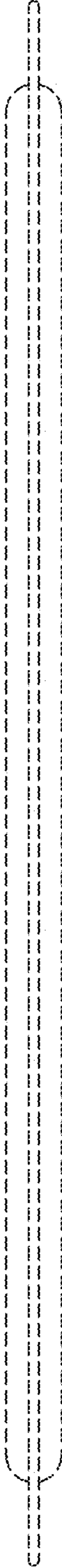

FIG. 8



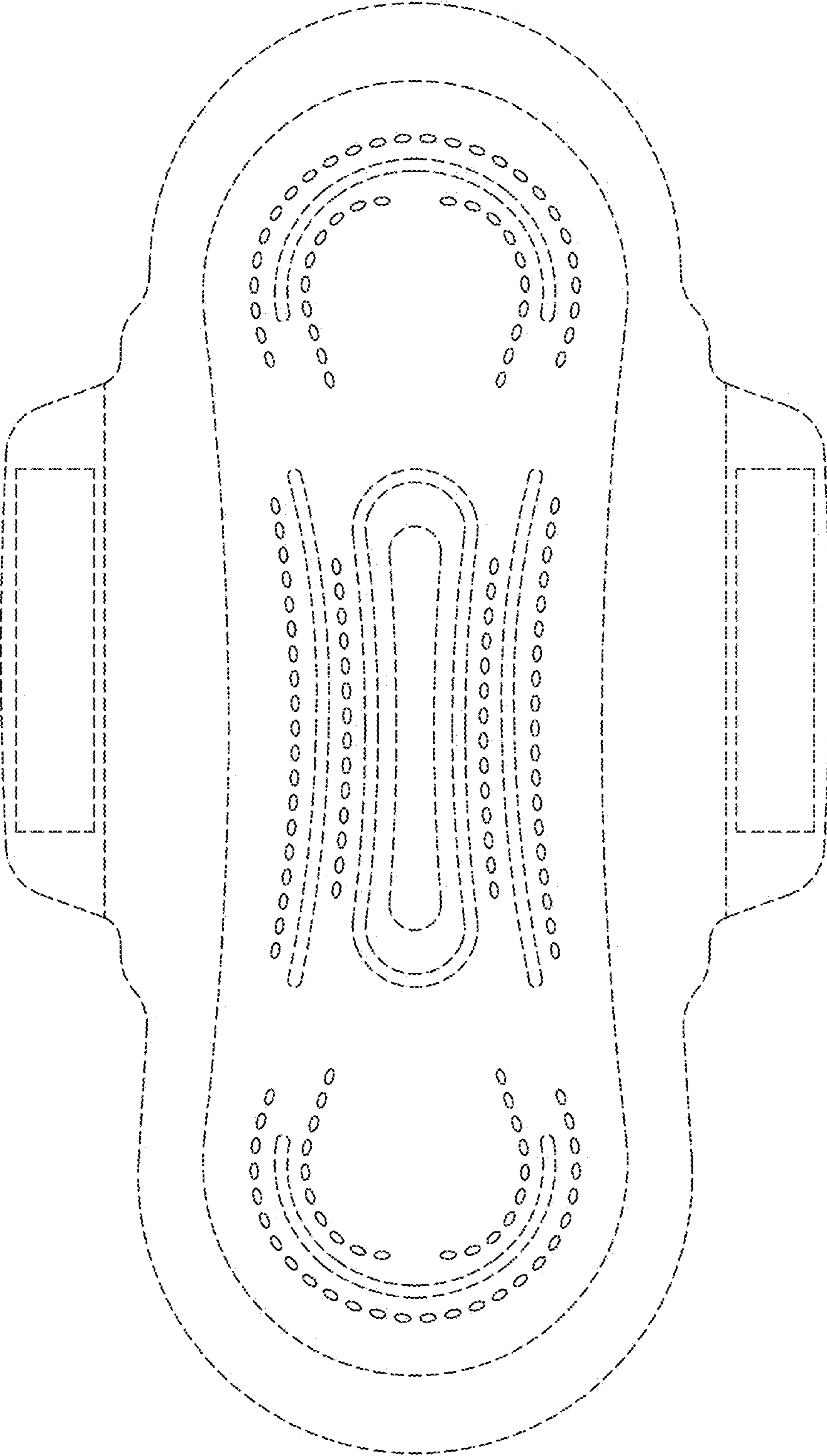

FIG. 9

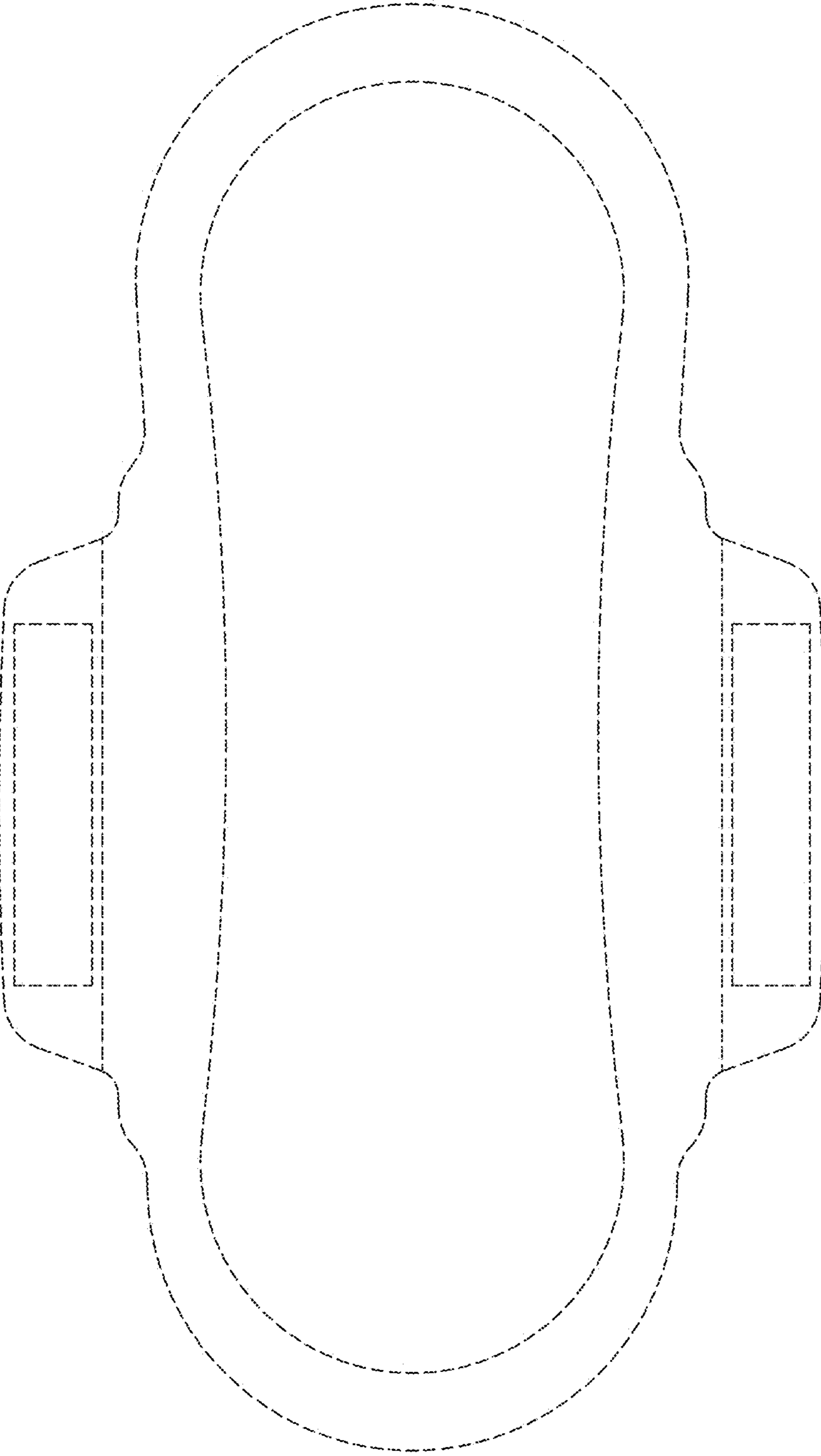

FIG. 10

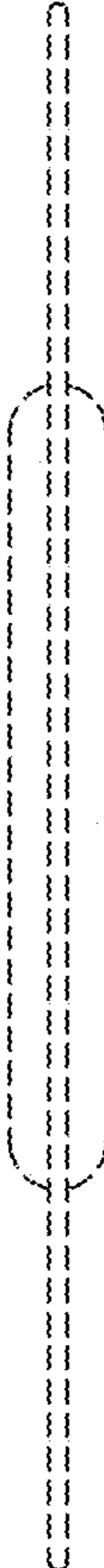

FIG. 11

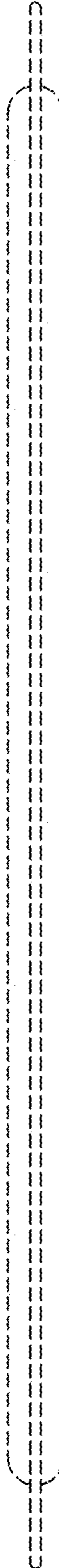

FIG. 12

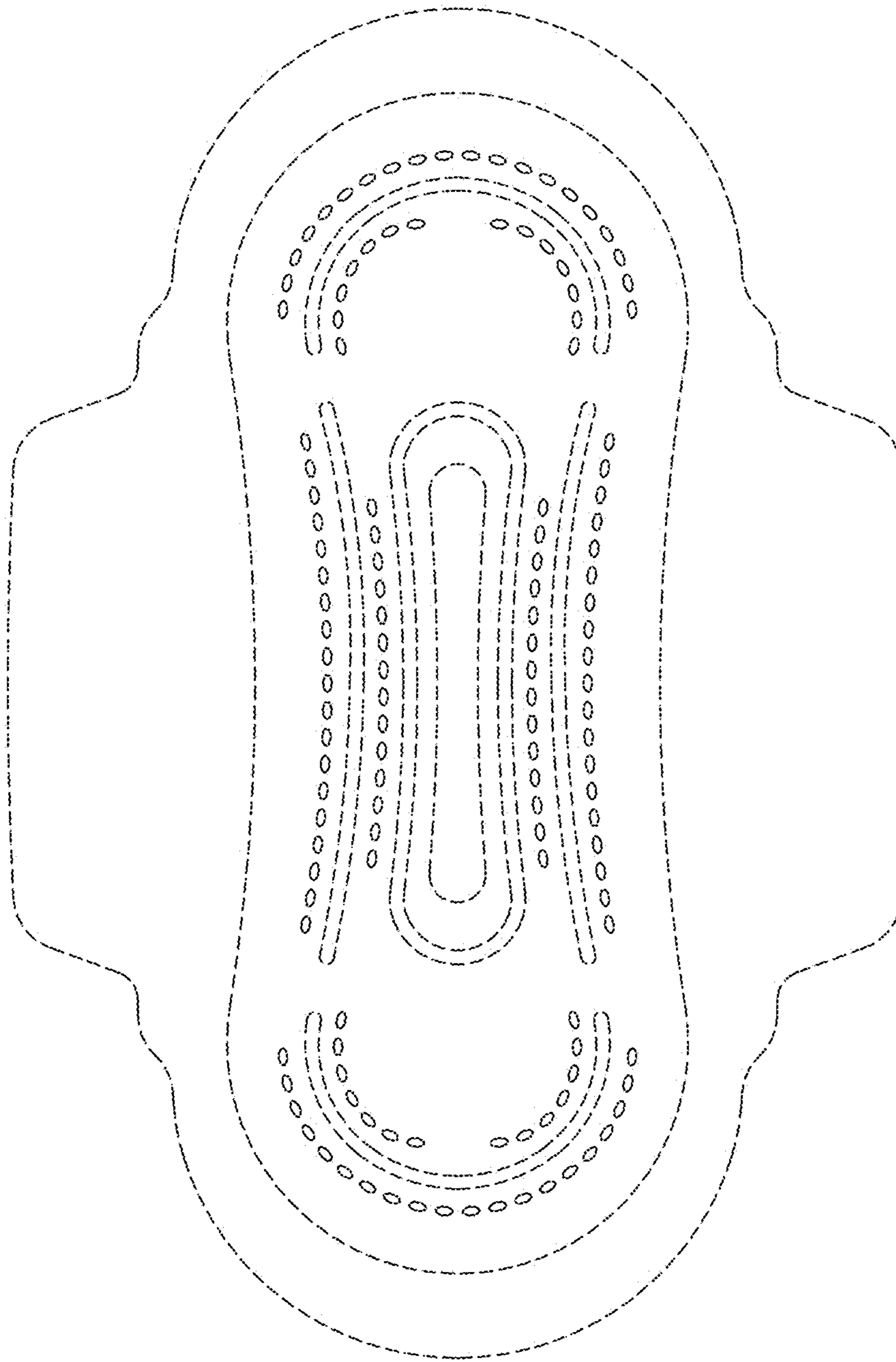

FIG. 13

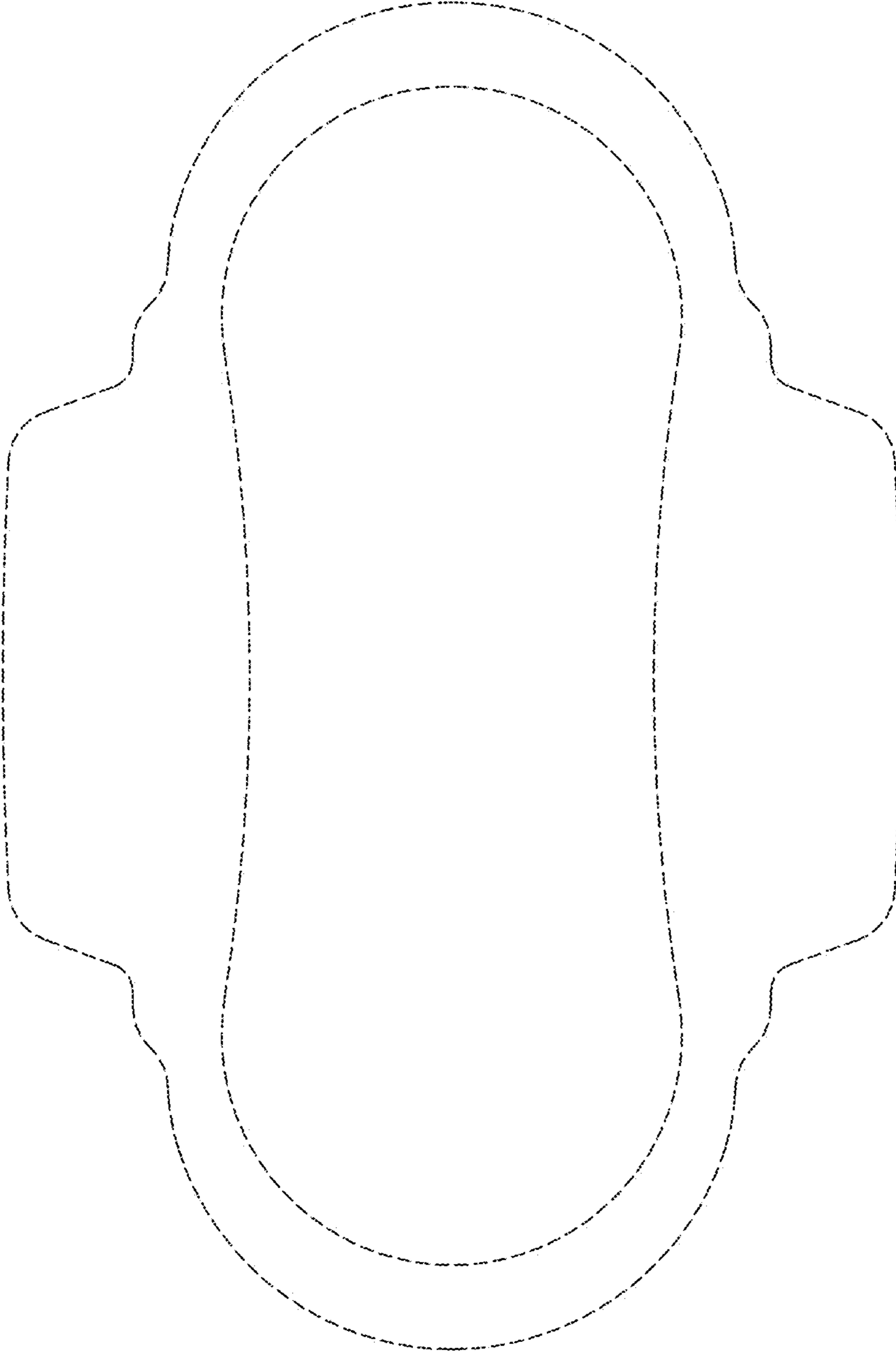

FIG. 14

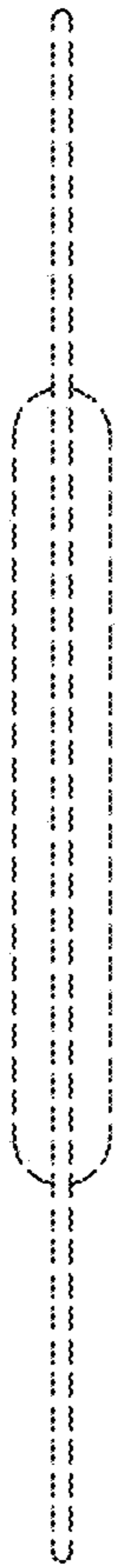

FIG. 15

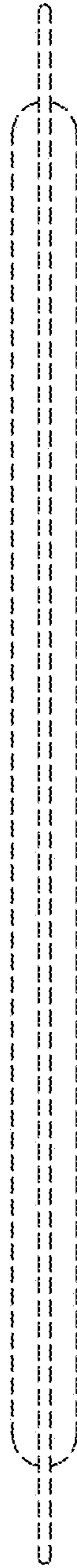

FIG. 16

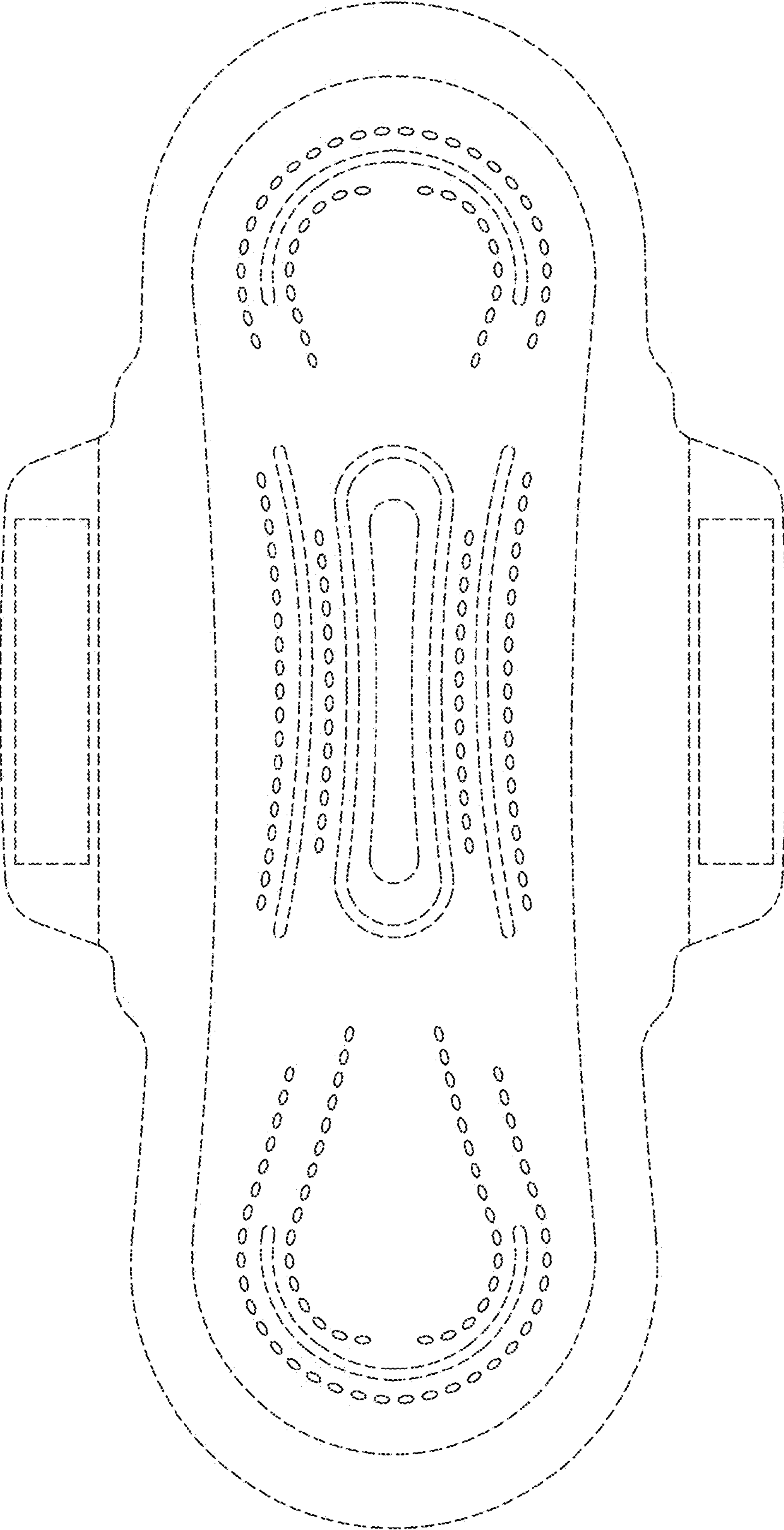

FIG. 17

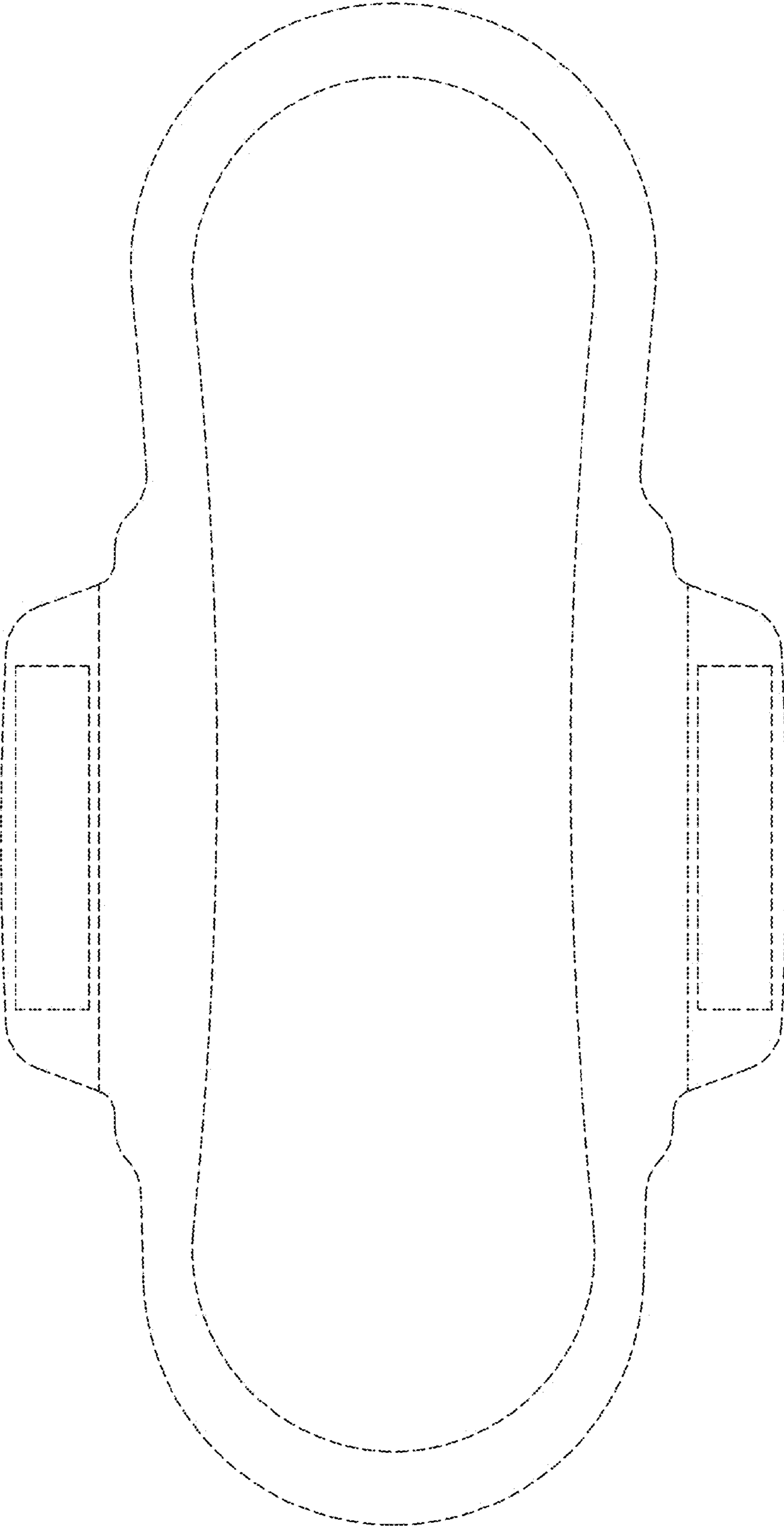

FIG. 18



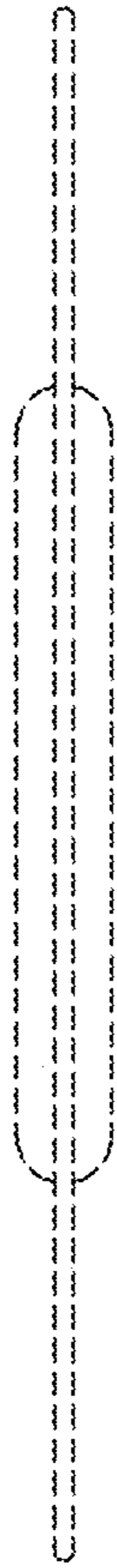

FIG. 19

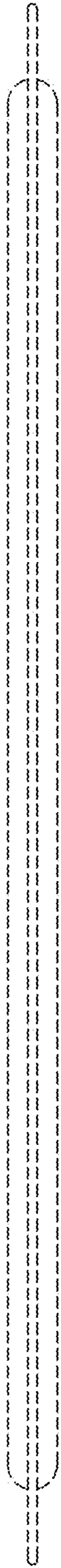

FIG. 20