



US00D715908S

(12) **United States Design Patent**  
**Shapiro**

(10) **Patent No.:** **US D715,908 S**

(45) **Date of Patent:** **\*\* Oct. 21, 2014**

(54) **BODY FOR A PORTABLE HEATER**

(71) Applicant: **Lasko Holdings, Inc.**, Wilmington, DE  
(US)

(72) Inventor: **Barry Shapiro**, Doylestown, PA (US)

(73) Assignee: **Lasko Holdings, Inc.**, Wilmington, DE  
(US)

(\*\*) Term: **14 Years**

(21) Appl. No.: **29/484,492**

(22) Filed: **Mar. 10, 2014**

(51) **LOC (10) Cl.** ..... **23-03**

(52) **U.S. Cl.**

USPC ..... **D23/332**

(58) **Field of Classification Search**

USPC ..... D23/314, 332, 335-350, 378, 370, 381,  
D23/354, 351, 386, 333, 328, 353, 361, 385,  
D23/417, 357; 392/365, 367, 424, 383, 411,  
392/360, 369, 373-376; 431/125; 126/183,  
126/110 B, 91 A, 500, 544, 547

See application file for complete search history.

(56) **References Cited**

U.S. PATENT DOCUMENTS

D633,609 S *	3/2011	Shapiro	.....	D23/314
D634,411 S *	3/2011	Shapiro	.....	D23/314
D651,706 S *	1/2012	Sidell	.....	D23/378
D685,077 S *	6/2013	Lewis	.....	D23/378
D693,448 S *	11/2013	Shapiro	.....	D23/332

\* cited by examiner

*Primary Examiner* — T. Chase Nelson

*Assistant Examiner* — Ania Aman

(74) *Attorney, Agent, or Firm* — Lange IP Law

(57) **CLAIM**

The ornamental design for a body for a portable heater, as shown and described.

**DESCRIPTION**

FIG. 1 is a right side front perspective view of a body for a portable heater showing my new design; FIG. 2 is a left side rear perspective view thereof; FIG. 3 is a front elevation view thereof; FIG. 4 is a right side elevation view thereof; FIG. 5 is a left side elevation view thereof; FIG. 6 is a rear elevation view thereof; and, FIG. 7 is a top plan view thereof.

The broken line showing of a front grill, a rear grill, a right side grill, a left side grill, front buttons, and a base are included for the purpose of illustrating environmental structure and forms no part of the claimed design.

**1 Claim, 7 Drawing Sheets**

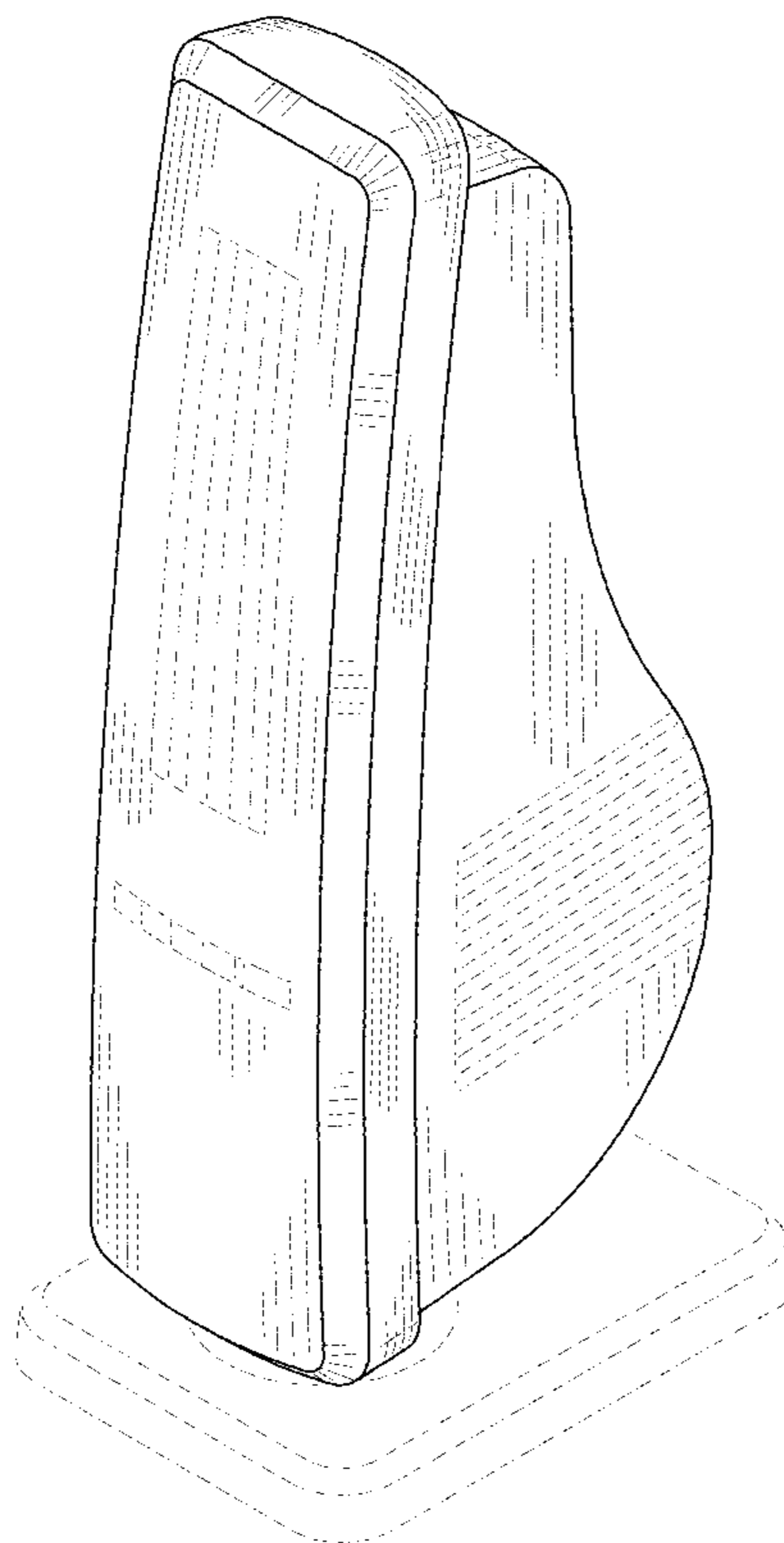

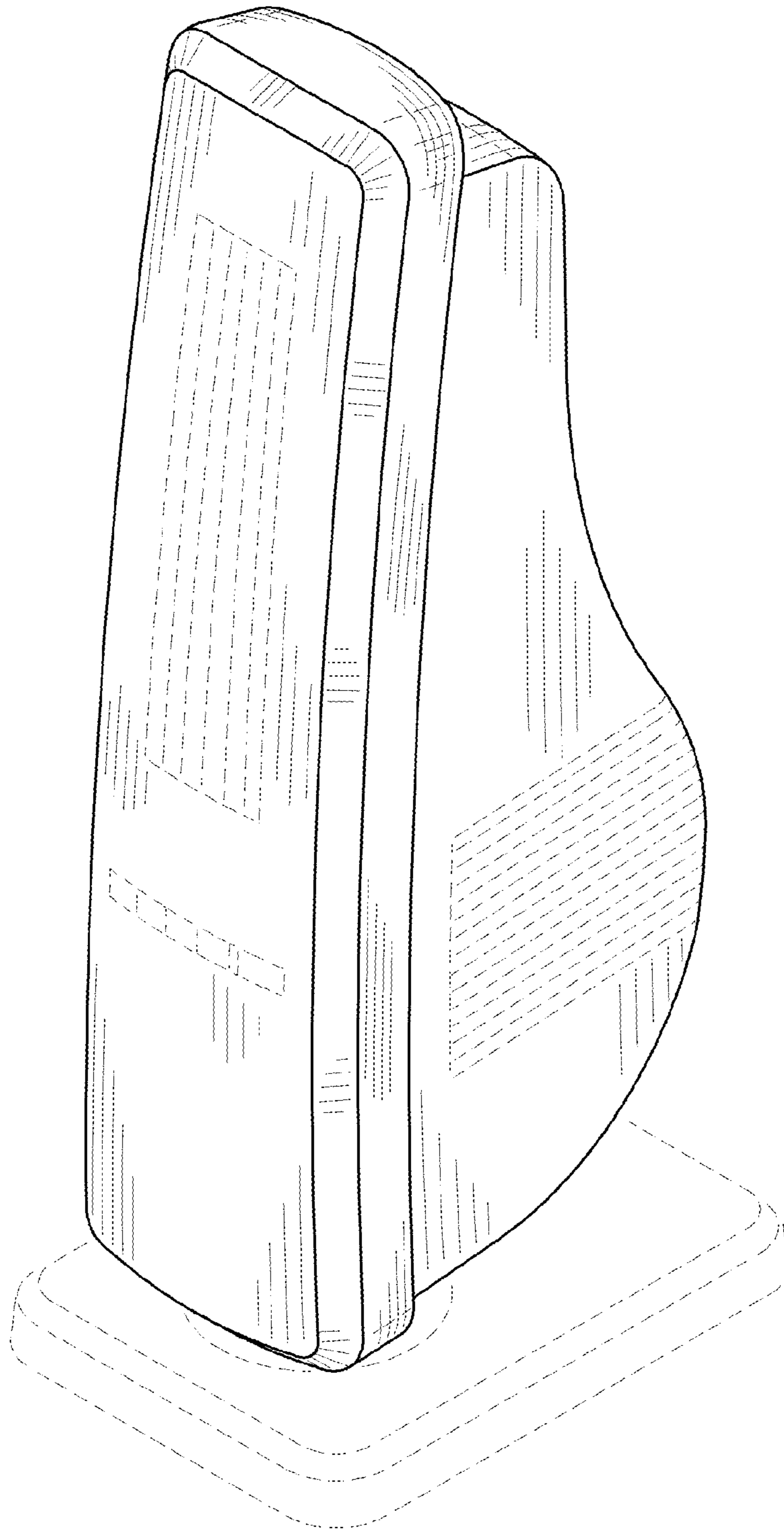
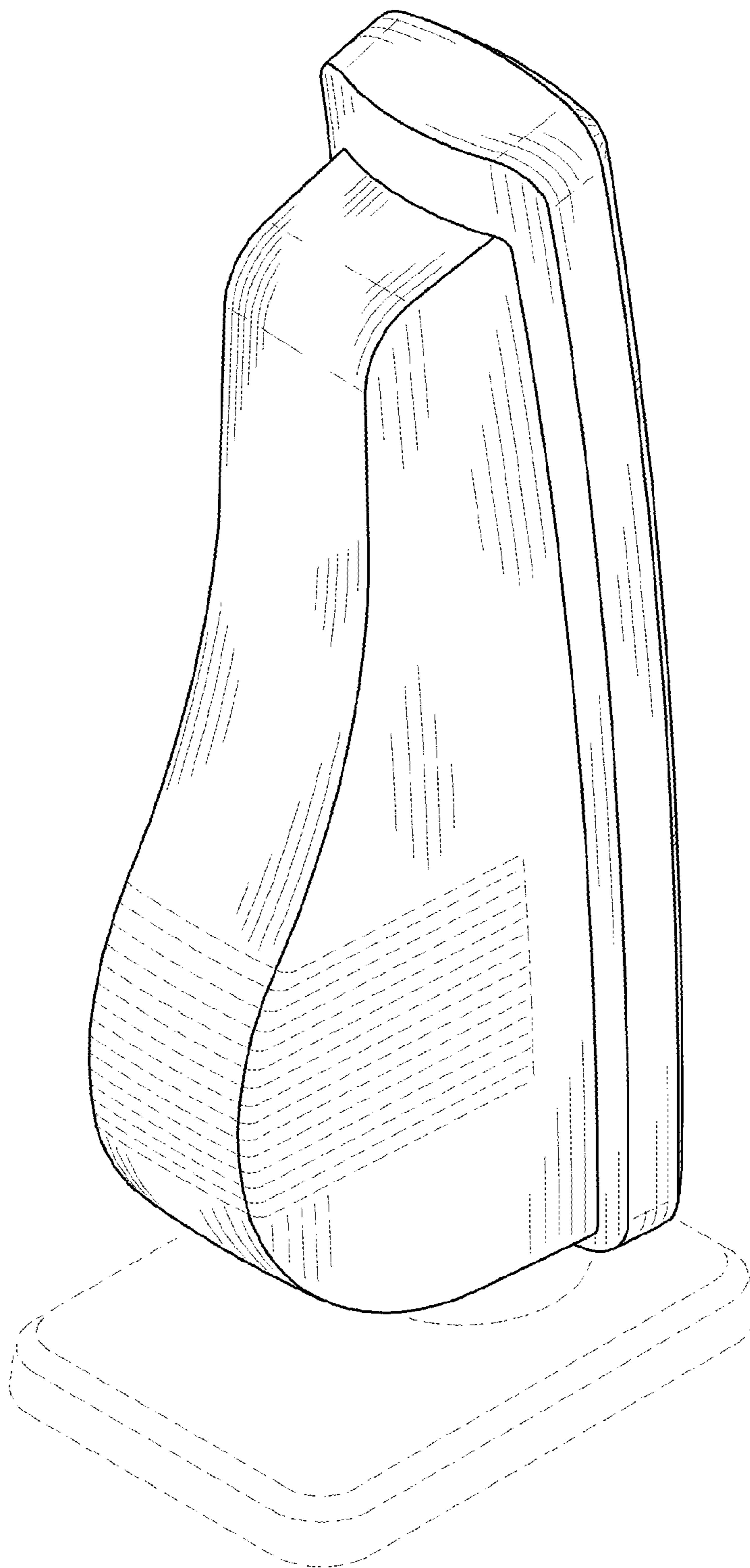

FIG. 1



**FIG. 2**

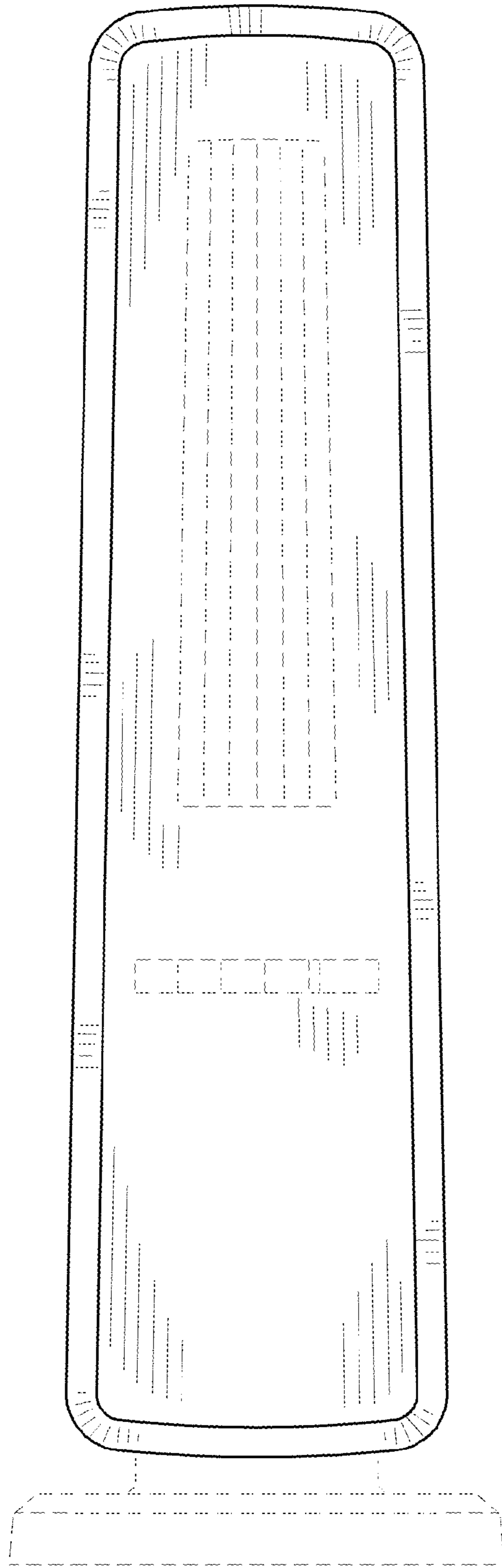

FIG. 3

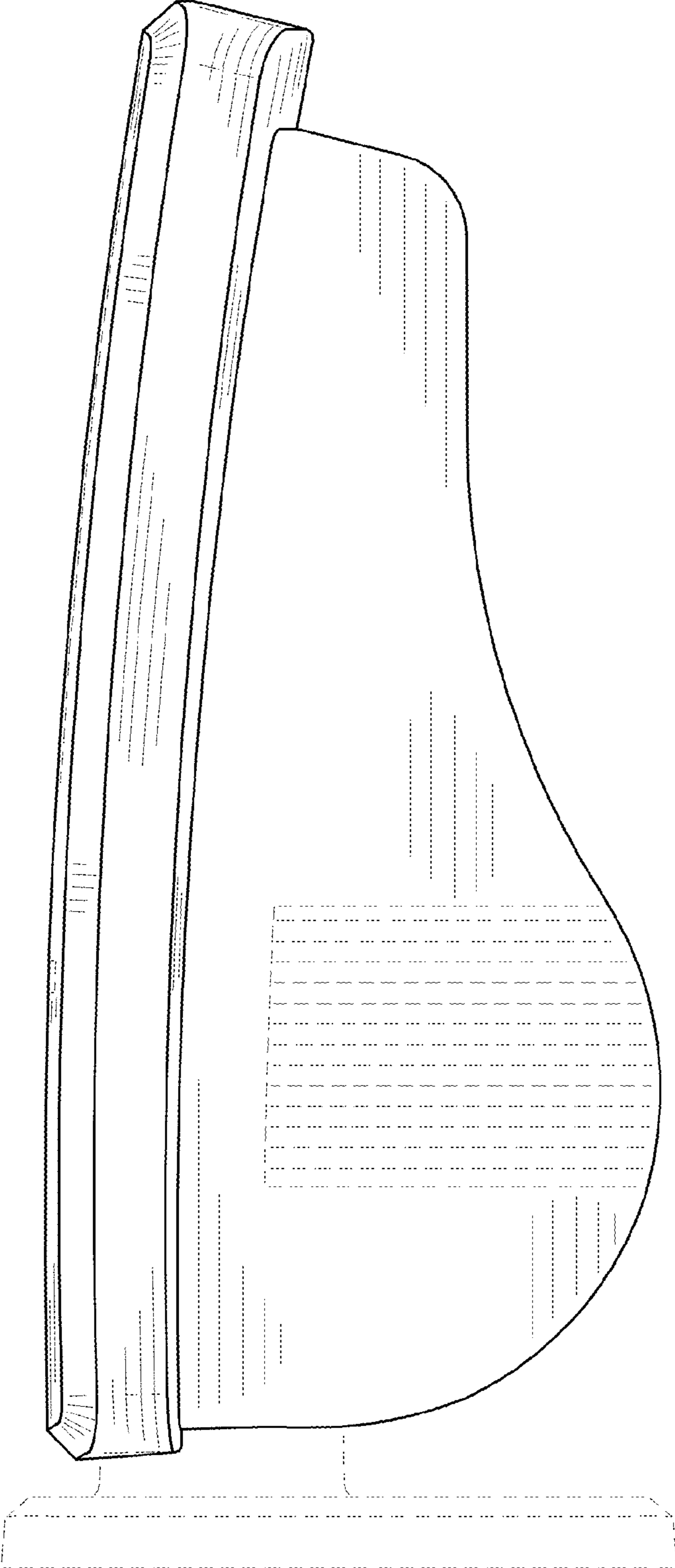

FIG. 4

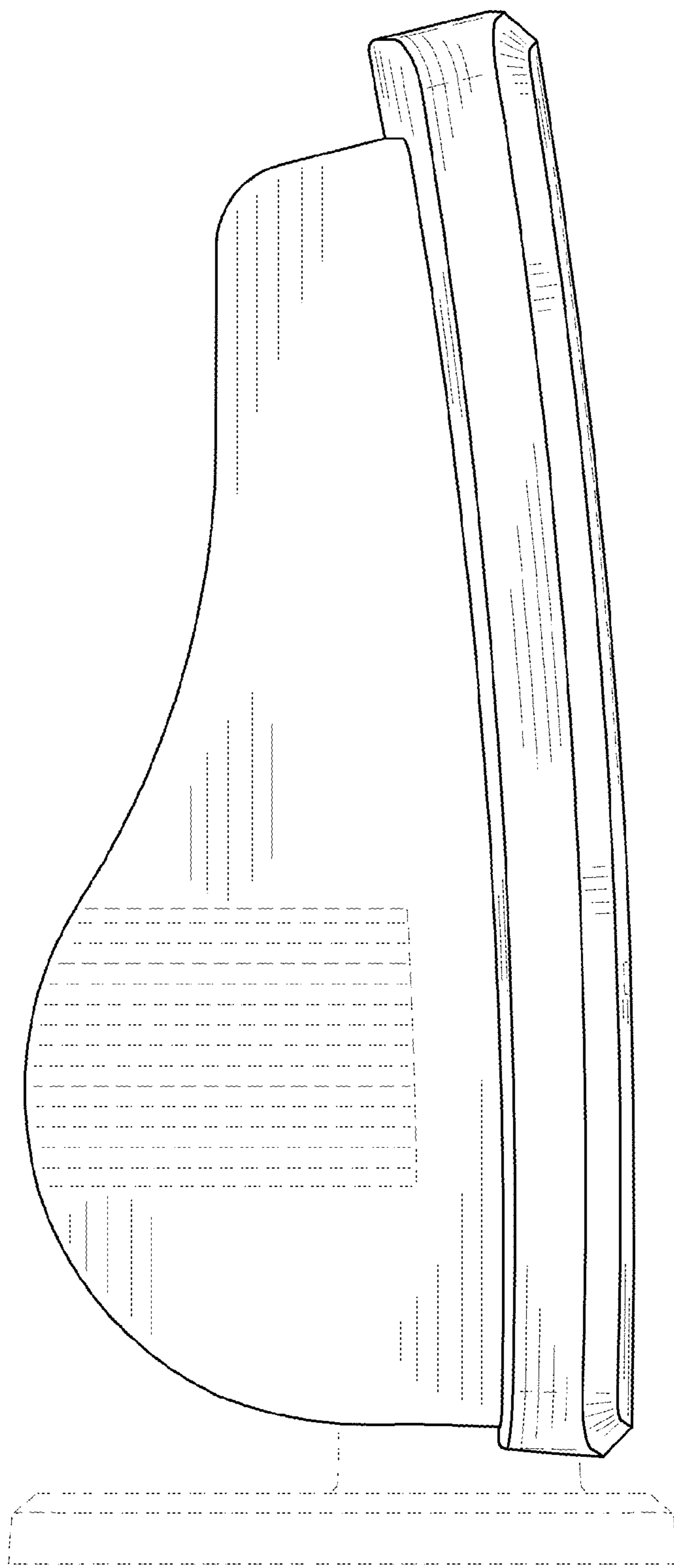

FIG. 5

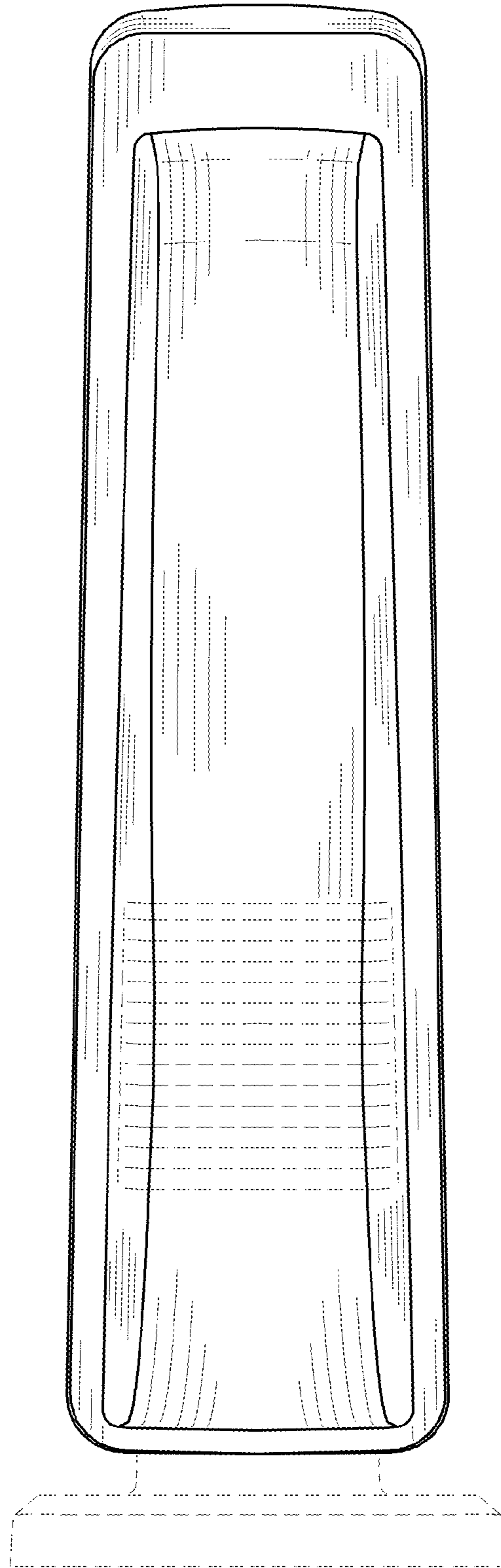

FIG. 6

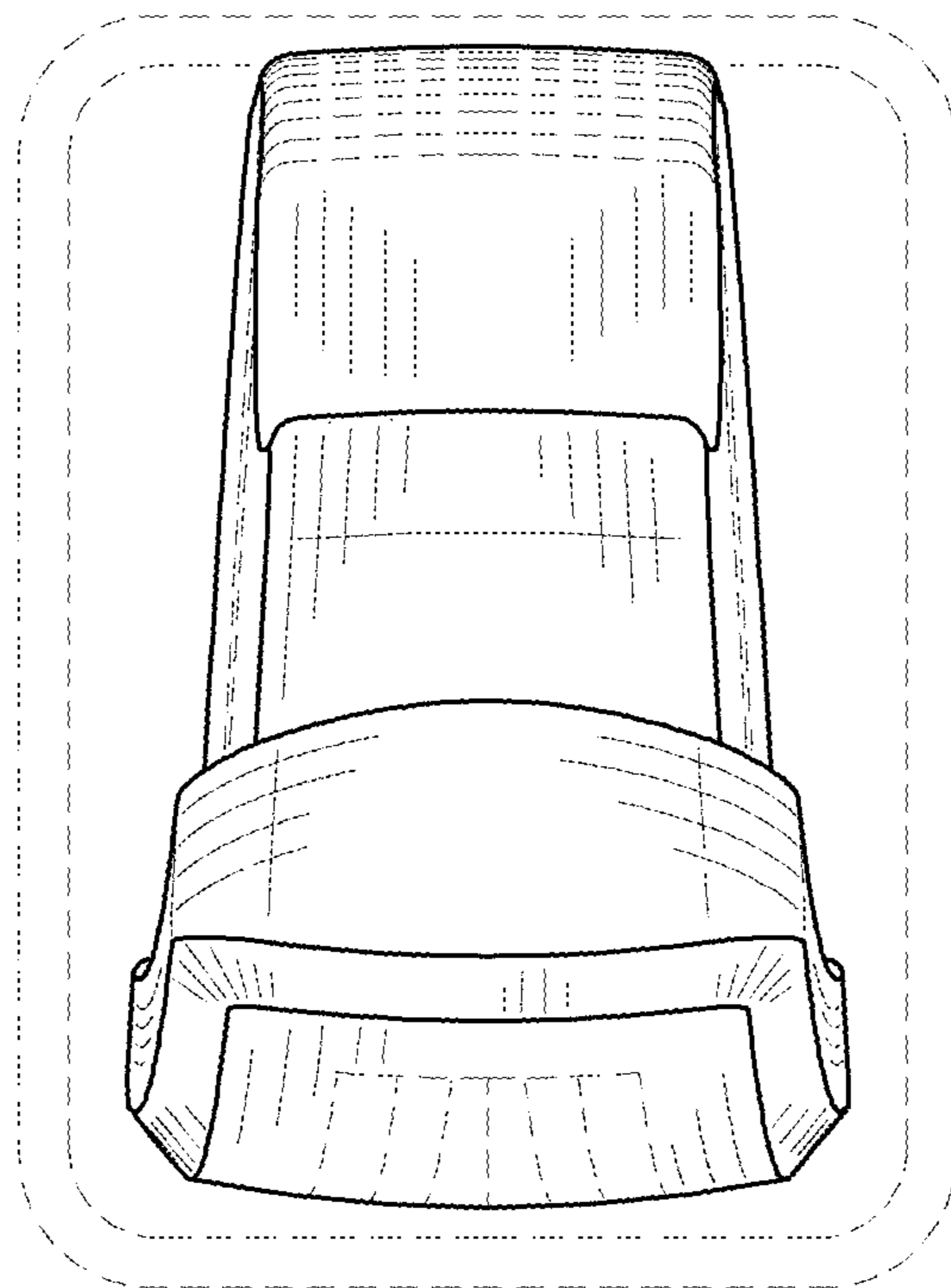

FIG. 7