



US00D715804S

(12) **United States Design Patent**  
**Frenzel**

(10) **Patent No.:** **US D715,804 S**

(45) **Date of Patent:** **\*\* Oct. 21, 2014**

(54) **TABLET COMPUTER STAND**

(71) Applicant: **Berend Frenzel**, Basel (CH)

(72) Inventor: **Berend Frenzel**, Basel (CH)

(\*\*) Term: **14 Years**

(21) Appl. No.: **29/476,886**

(22) Filed: **Dec. 18, 2013**

(51) **LOC (10) Cl.** ..... **08-07**

(52) **U.S. Cl.**

USPC ..... **D14/447**

(58) **Field of Classification Search**

USPC ..... D14/447, 432, 433, 434, 439, 440, 451,  
D14/452, 457, 459, 460, 461, 251, 253, 448,  
D14/449, 450; D9/433, 455, 457; D20/10,  
D20/25; D6/672, 674, 674.1, 678, 682,  
D6/682.3; 40/124.05, 124.06, 124.07,  
40/124.08, 124.09, 124.14, 124.16, 539;  
248/917-924, 445, 447.1, 451, 456,  
248/459, 460, 150, 152, 174, 188.6, 176.1;  
361/679.02, 679.09, 679.21, 679.26,  
361/679.3, 679.27, 679.55, 679.56  
See application file for complete search history.

(56) **References Cited**

**U.S. PATENT DOCUMENTS**

3,376,009 A 4/1968 Domino  
5,915,661 A 6/1999 Silverman et al.

(Continued)

**FOREIGN PATENT DOCUMENTS**

DE 202011105156 1/2012  
DE 202012007744 1/2013

**OTHER PUBLICATIONS**

Chaise Universal Tablet Stand by Kensington, 2012.

(Continued)

*Primary Examiner* — Angela J Lee

(74) *Attorney, Agent, or Firm* — Schiff & Hardin LLP

(57) **CLAIM**

The ornamental design for a tablet computer stand, as shown and described.

**DESCRIPTION**

The present application is related to utility application 13/781,046, filed Feb. 28, 2013 titled “Multiple Footprint Stand for a Tablet Computer”, Berend Frenzel, inventor.

FIG. 1 is a perspective view of a first embodiment of a tablet computer stand taken from a direction between a front and a right side of the tablet computer stand;

FIG. 2 is a top plan view of the tablet computer stand of FIG. 1;

FIG. 3 is a bottom plan view of the tablet computer stand of FIG. 1;

FIG. 4 is a right side elevational view of the tablet computer stand of FIG. 1;

FIG. 5 is a left side elevational view of the tablet computer stand of FIG. 1;

FIG. 6 is a front elevational view of the tablet computer stand of FIG. 1;

FIG. 7 is a back elevational view of the tablet computer stand of FIG. 1.

FIG. 8 is a perspective view of a second embodiment of a tablet computer stand taken from a direction between a front and a right side of the tablet computer stand;

FIG. 9 is a top plan view of the tablet computer stand of FIG. 8;

FIG. 10 is a bottom plan view of the tablet computer stand of FIG. 8;

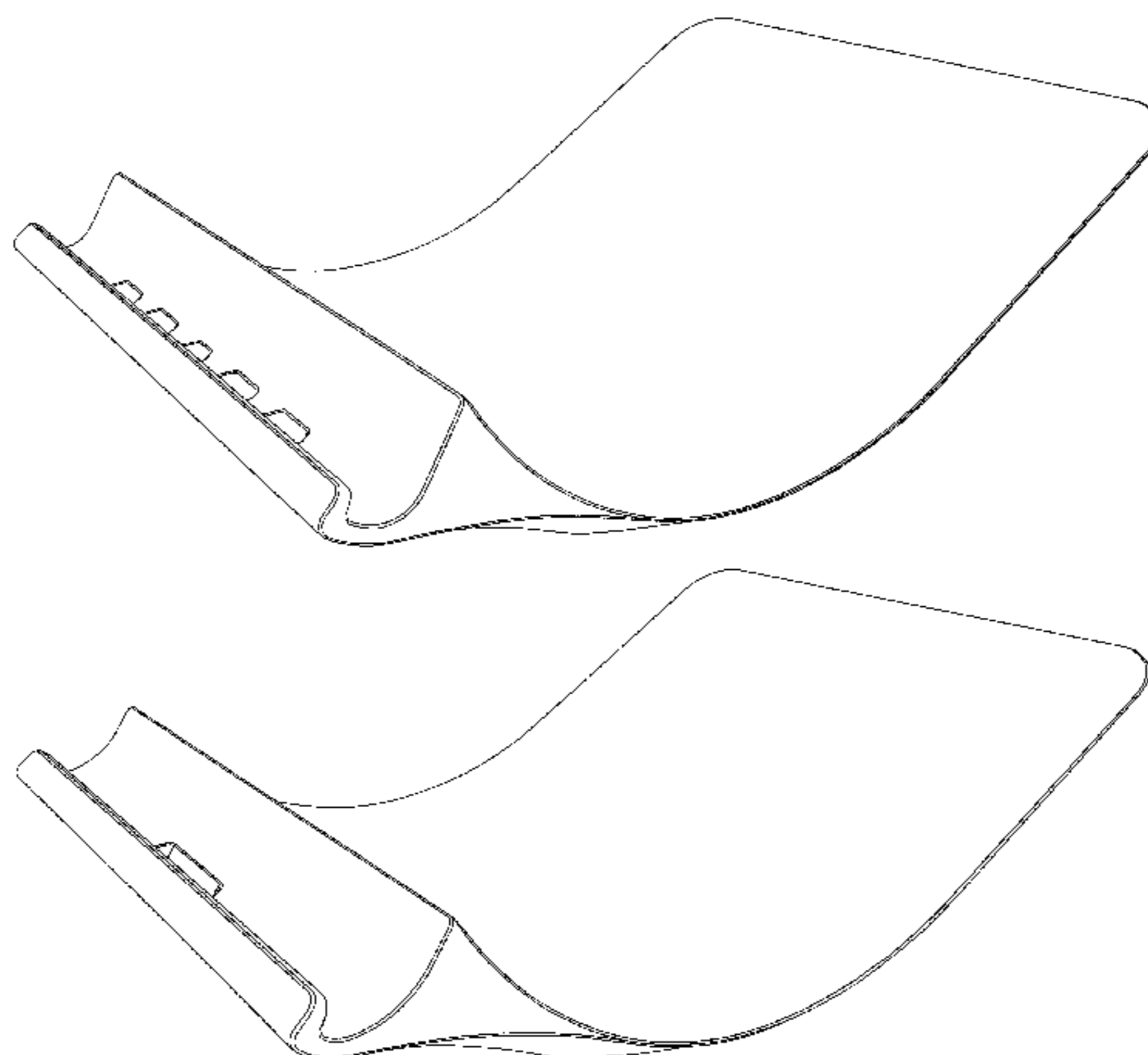
FIG. 11 is a right side elevational view of tablet computer stand of FIG. 8;

FIG. 12 is a left side elevational view of the tablet computer stand of FIG. 8;

FIG. 13 is a front elevational view of the tablet computer stand of FIG. 8; and,

FIG. 14 is a back elevational view of the tablet computer stand of FIG. 8.

**1 Claim, 10 Drawing Sheets**



(56)

References Cited

U.S. PATENT DOCUMENTS

D455,755 S *	4/2002	Levine et al.	.....	D14/447
D558,192 S *	12/2007	Daly et al.	.....	D14/251
D571,815 S *	6/2008	Chung	.....	D14/447
D574,375 S *	8/2008	Prest et al.	.....	D14/253
D598,920 S *	8/2009	Fujino et al.	.....	D14/447
D618,692 S *	6/2010	Deutsch et al.	.....	D14/447
D620,942 S *	8/2010	Huang	.....	D14/447
D626,129 S *	10/2010	Lutz	.....	D14/447
D640,705 S *	6/2011	Sogabe	.....	D14/447
D640,708 S *	6/2011	Lee	.....	D14/447
D661,308 S *	6/2012	Capozzoli, II	.....	D14/447
8,344,836 B2	1/2013	Lauder et al.		
D682,282 S *	5/2013	Steinfeld	.....	D14/447
D693,826 S *	11/2013	Ashida et al.	.....	D14/447

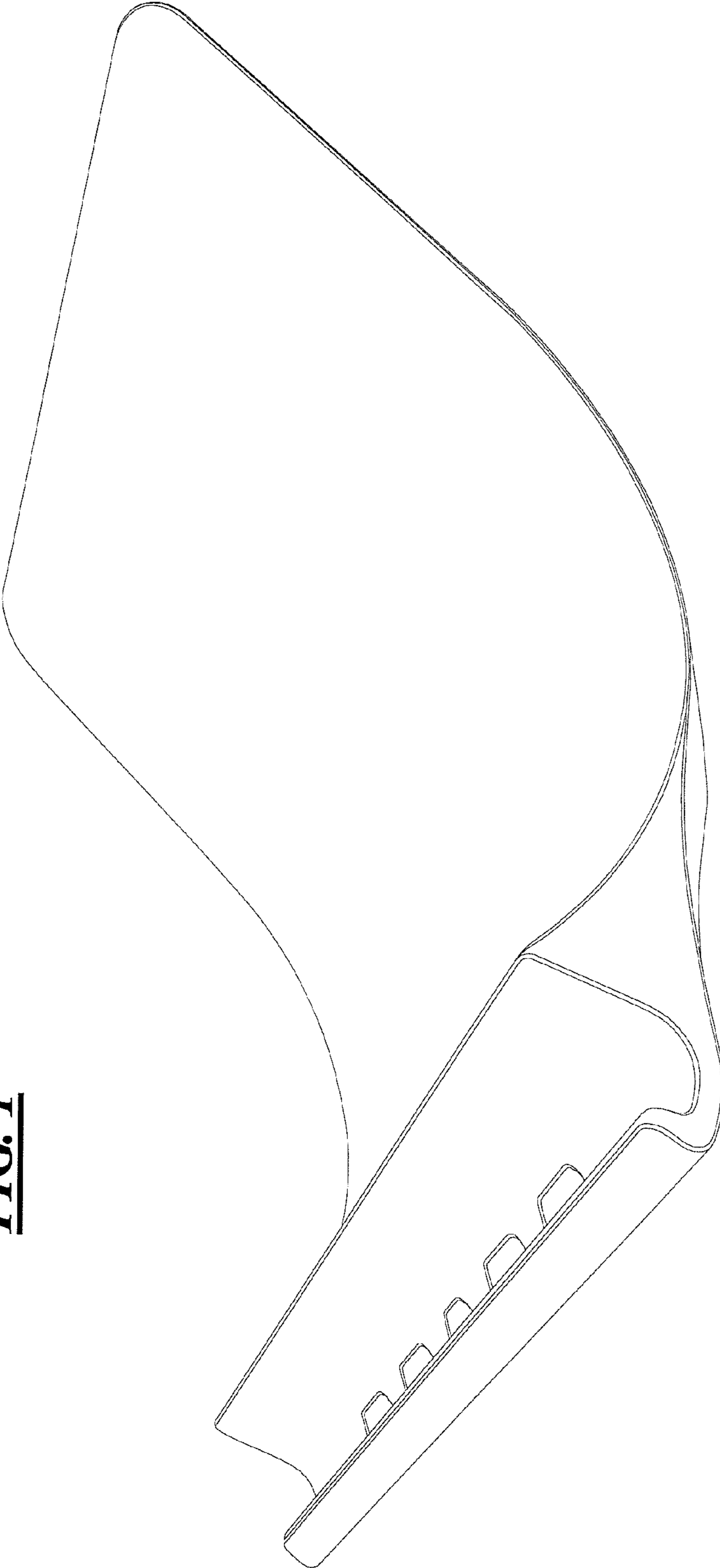
OTHER PUBLICATIONS

Magnus by Ten One Design, 2012.  
 Boomerang by Xvida, 2012.  
 Tablet Holding Arm, 2012.  
 H4 Holder by Luxa2, 2012.  
 Compas Mobile Stand by Twelvesouth, 2012.  
 Smar Cover Leder Etui by Case and More, 2012.  
 HexaPose by Innopocket, 2012.  
 Leather Case by iOffer, 2012.  
 Joule by Element Case, 2012.  
 Luxa H4 Holder, 2012.  
 Slide by Just Mobile, 2012.  
 Nest by Bluelounge, 2012.  
 Smart Cover by Apple Inc., 2012.

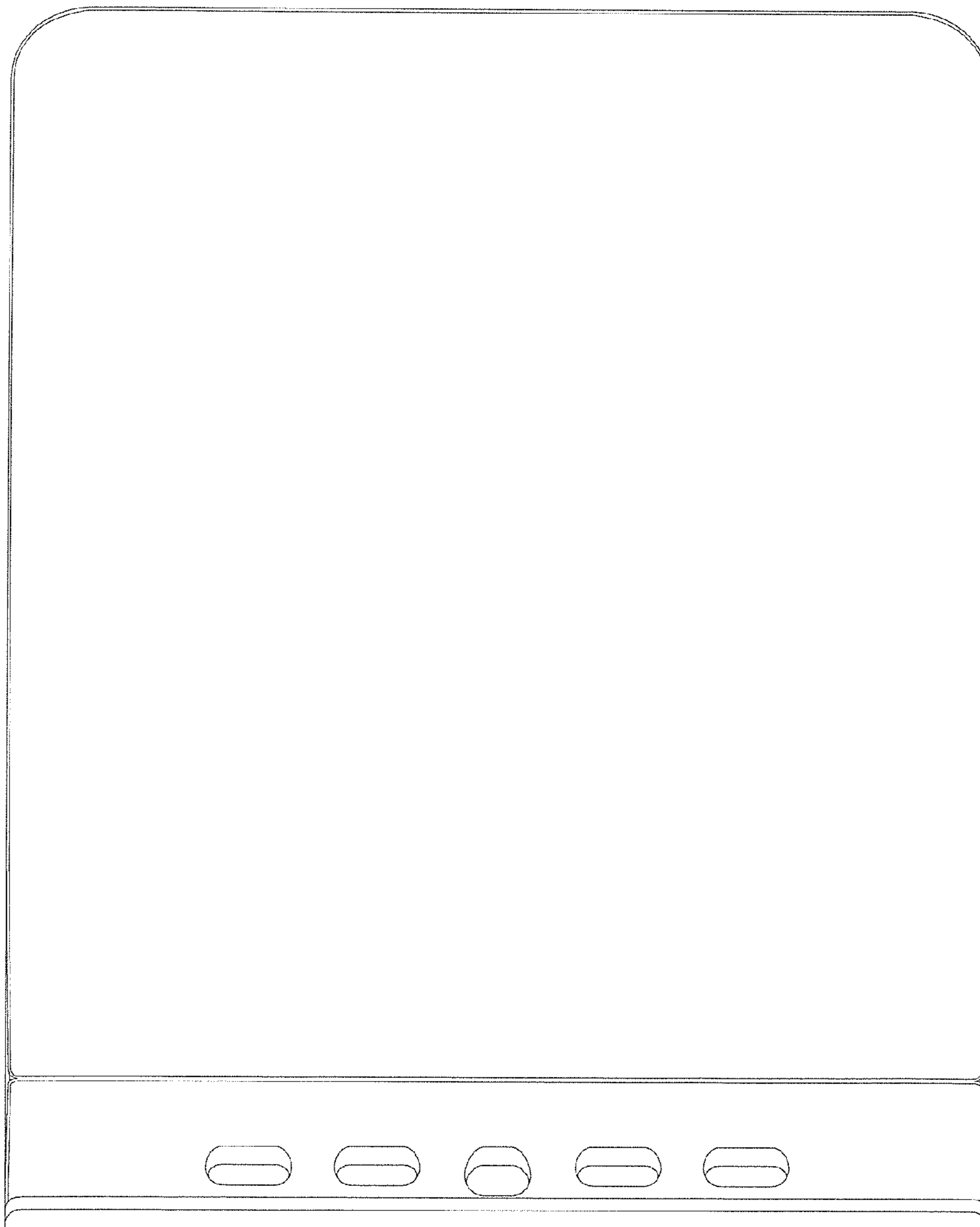
@Rest by Heckler Design, 2012.  
 Block 22 by Sherwood Meister, 2012.  
 iPad Recliner by Lap Works, 2012.  
 P2 by Eleago Design, 2012.  
 Facet Pyramid by iLovehandles, 2012.  
 Wooden iPad Stand by Fel Tu, 2012.  
 A-Frame by Griffin, 2012.  
 Book Arc by Twelvesouth, 2012.  
 Up Stand by Just Mobile, 2012.  
 Stump Stand, 2012.  
 Chef Stand by Belkin, 2012.  
 Infinite Loop Stand by Infinitloop, 2012.  
 iPad Halter Serie XF3 Padholder, 2012.  
 Mobile Stand for iPad by humantoolz, 2012.  
 Multi Angle Acrylic Desktop Stand by iStyleCity, 2012.  
 SGP Case Rotate by Element Case, 2012.  
 iPad Security Display Stand by Yomo Security Display Co., Ltd, 2012.  
 Up-4 Stand by Gadget Kingdom, 2012.  
 Peacock Stand for Tablets, 2012.  
 2A Wire Display Stand by Gibson Holders, 2012.  
 Pad Pivot by Uifit, 2012.  
 iRest by Raindesign inc., 2012.  
 Loop by Griffin, 2012.  
 Mona by brisbin, 2012.  
 Desktop Chair by Moku Woodware, 2012.  
 Portable Folding Stand, 2012.  
 A-Fold by wohnbedarf, 2012.  
 Miniot Wood Mk2 by Miniot, 2012.  
 Skadoosh Flip Stand by Jadu Industries, 2012.  
 Camp Fire by X-Doria, 2012.

\* cited by examiner

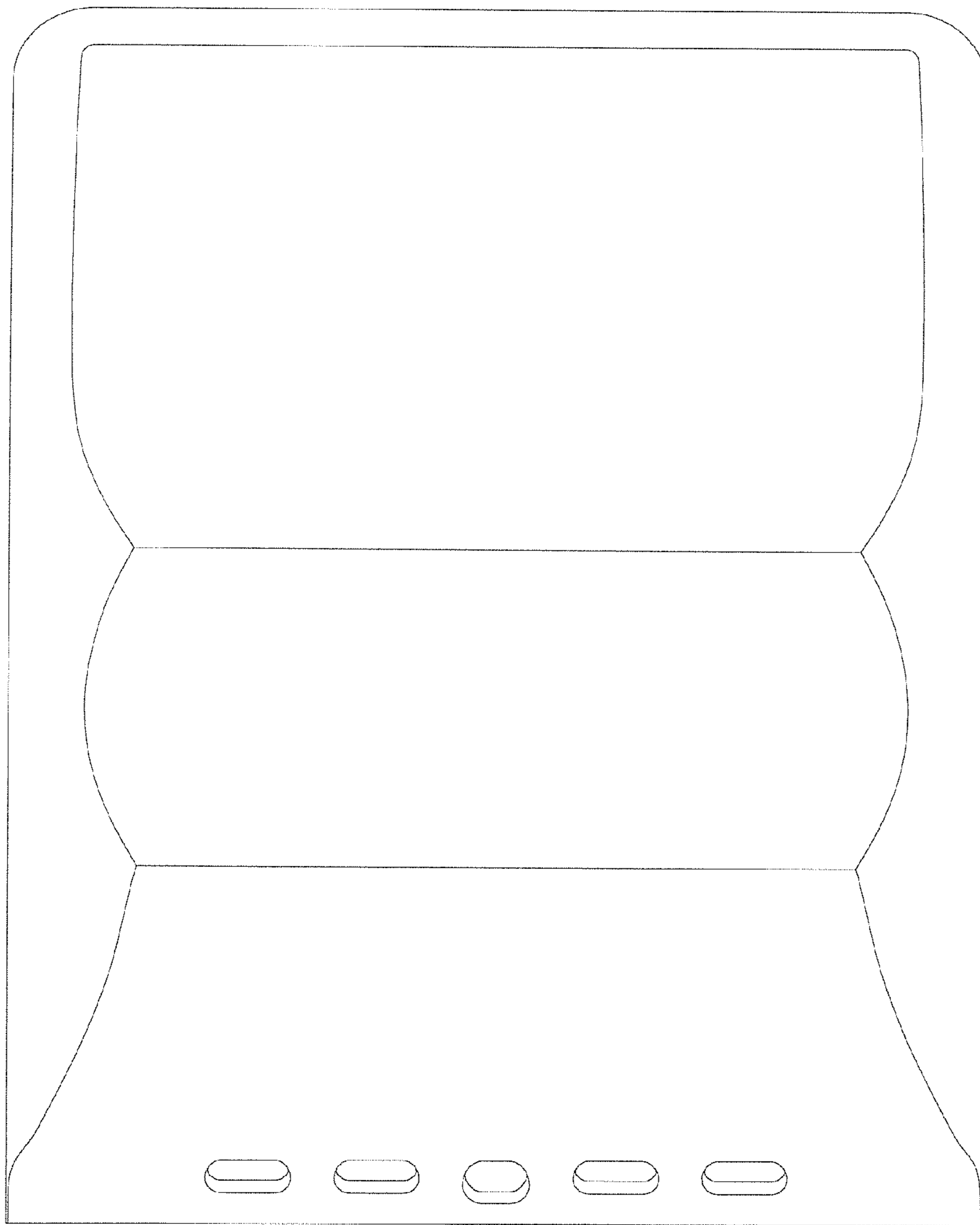
**FIG. 1**

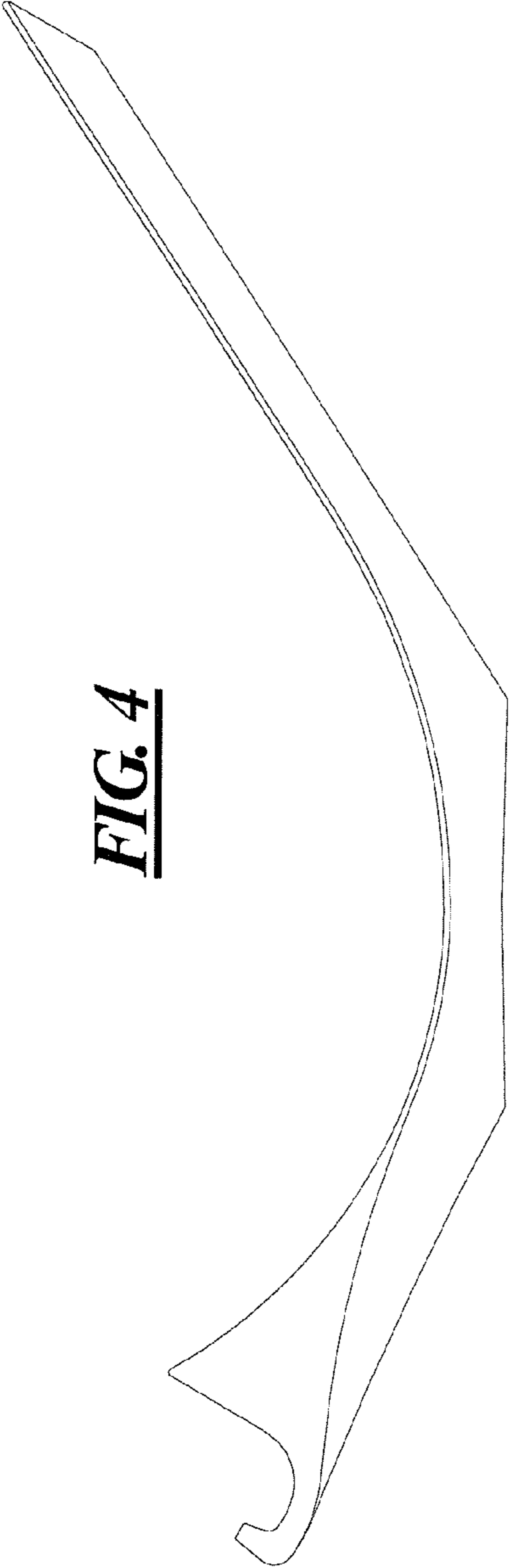


**FIG. 2**

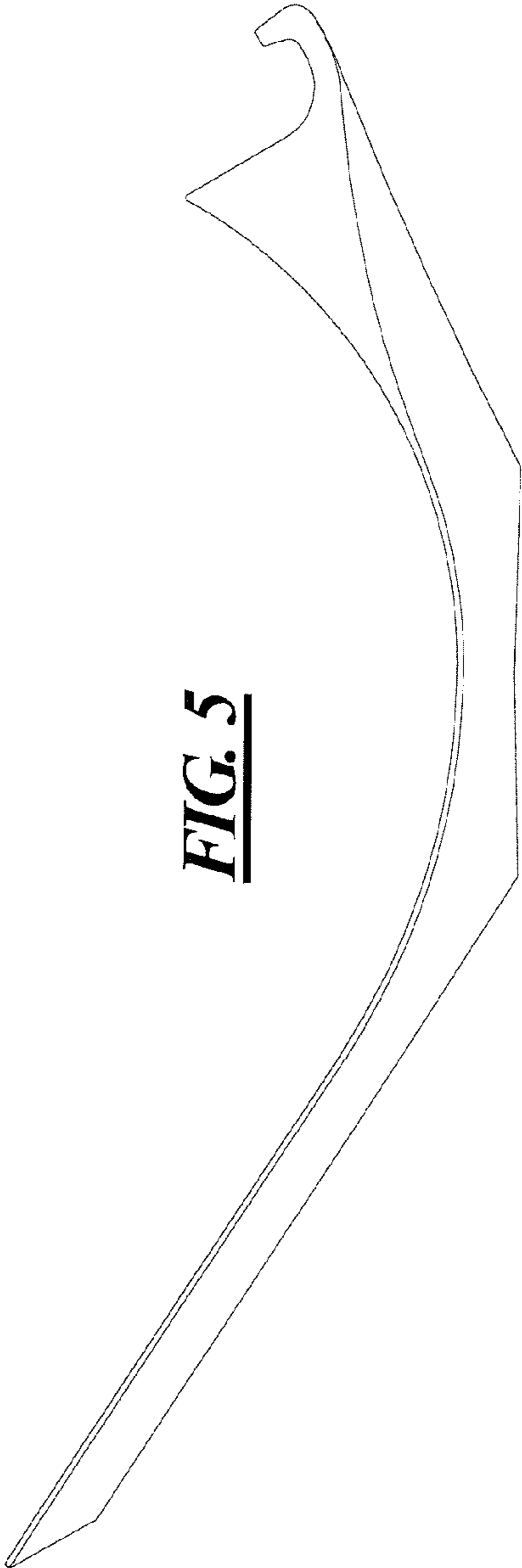


**FIG. 3**





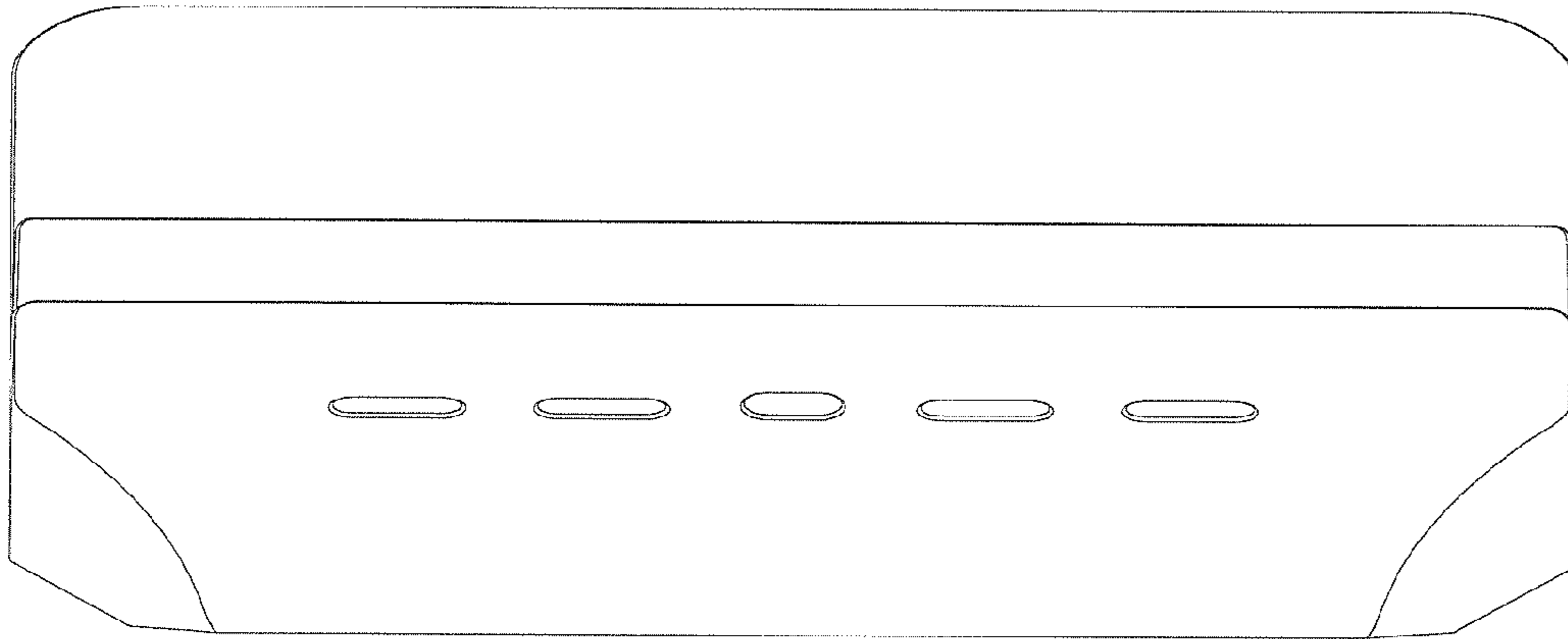
**FIG. 4**



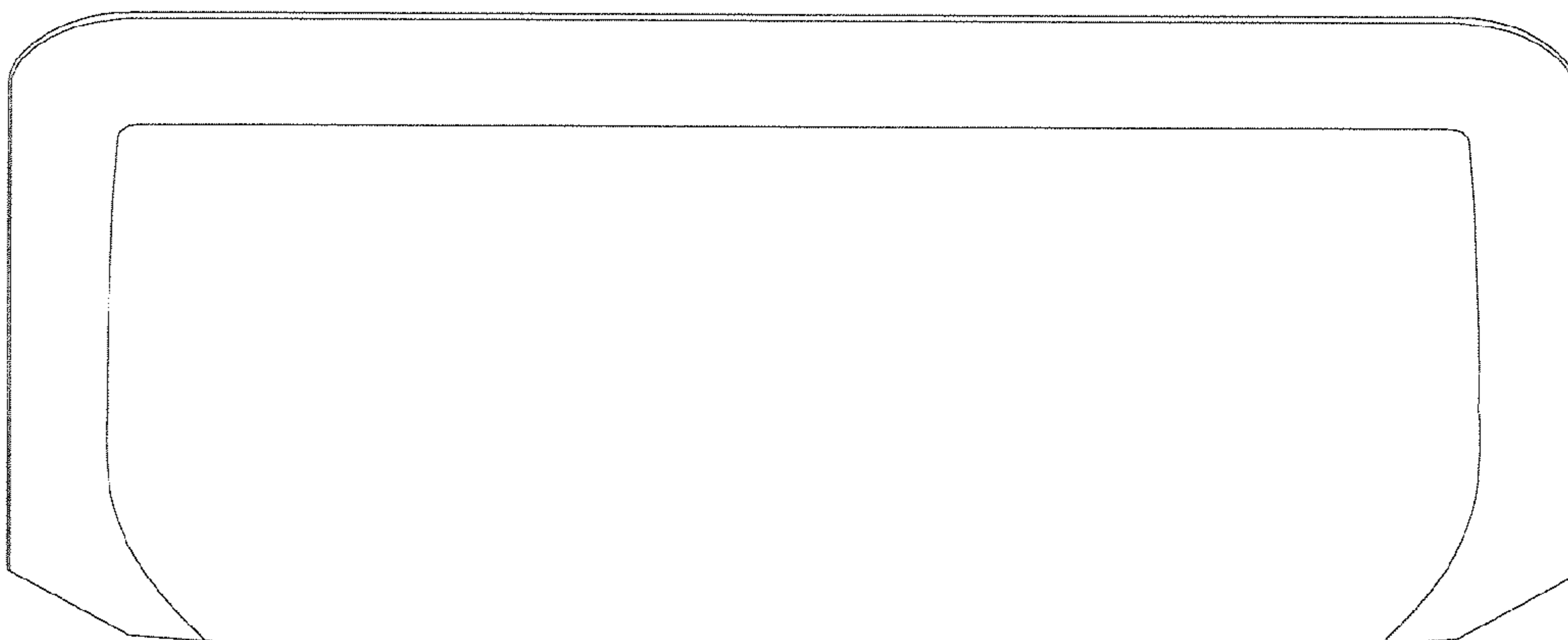
**FIG. 5**

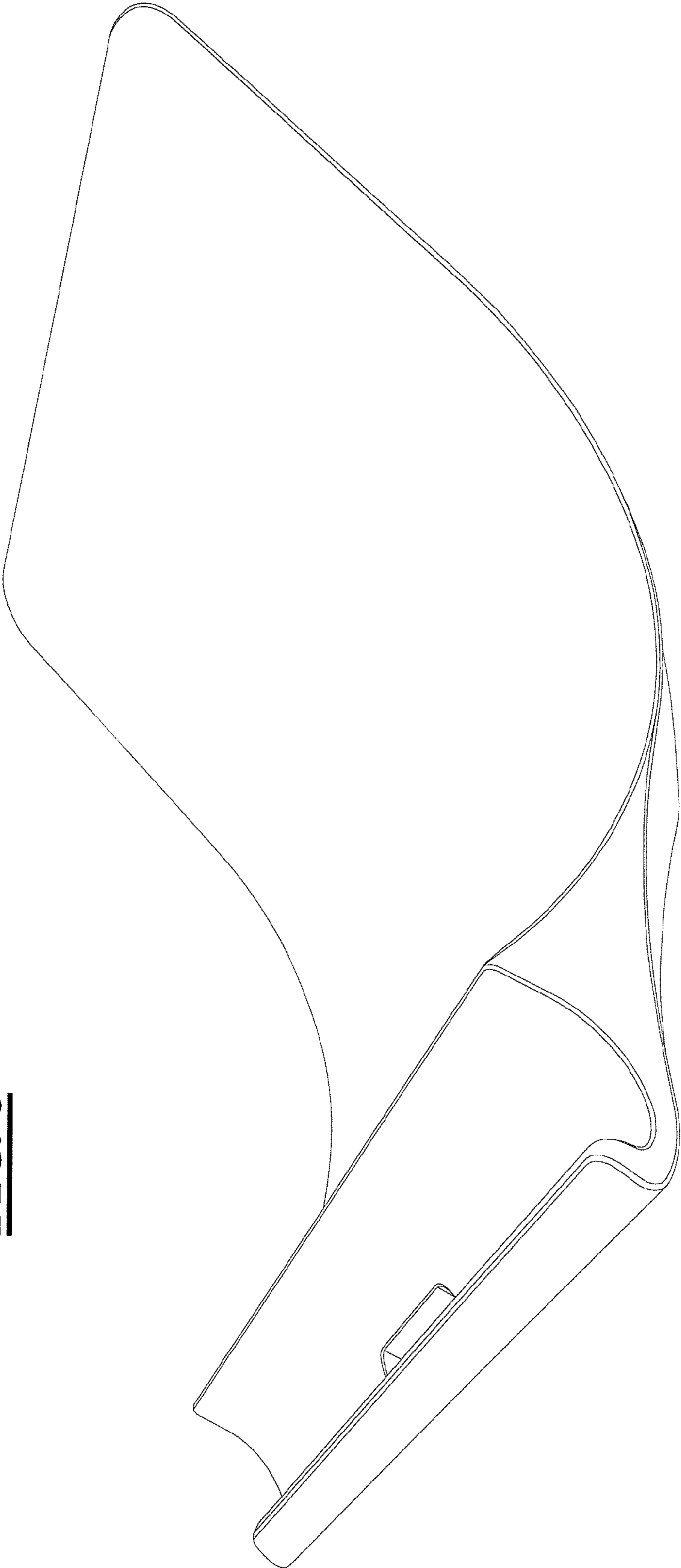


**FIG. 6**



**FIG. 7**

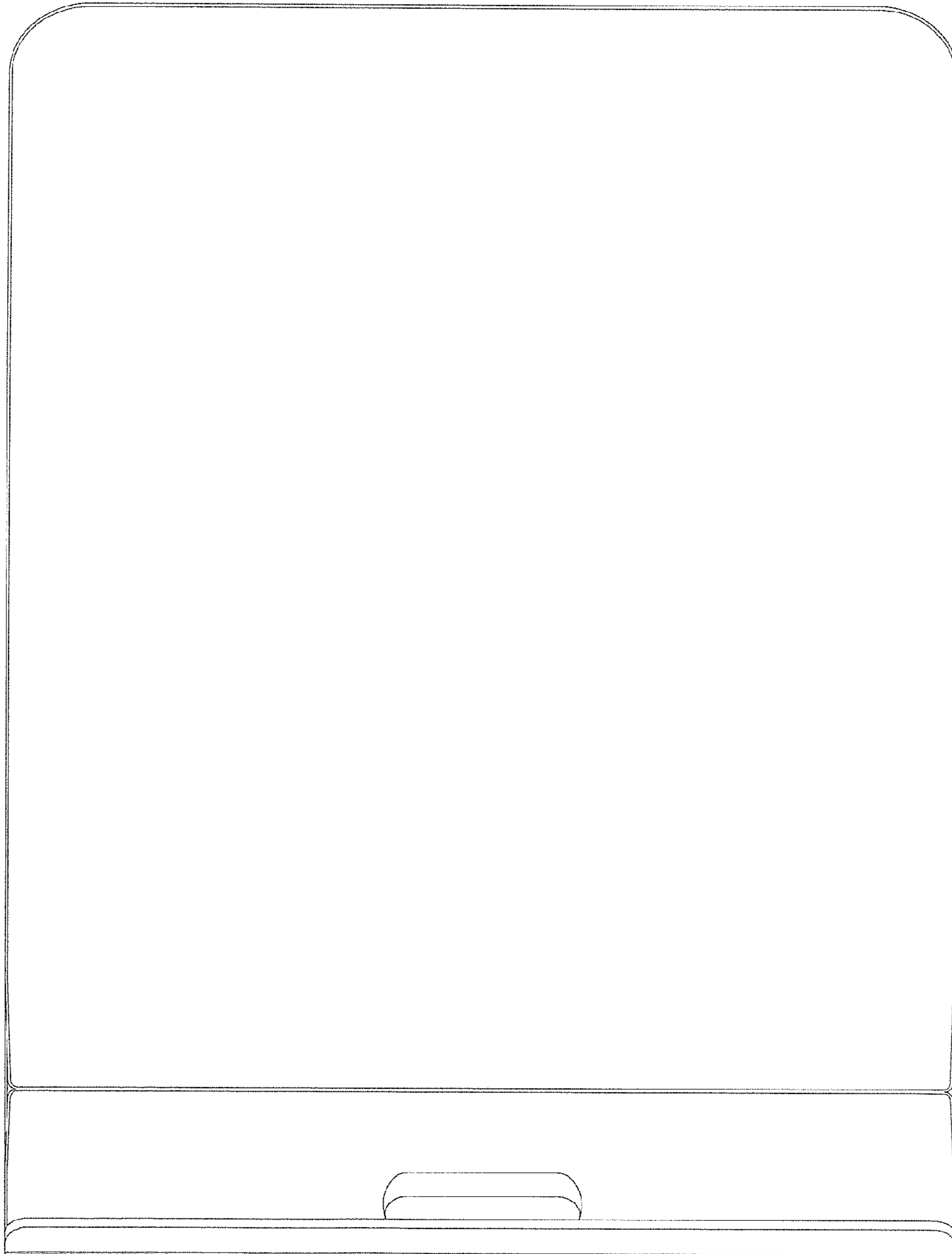




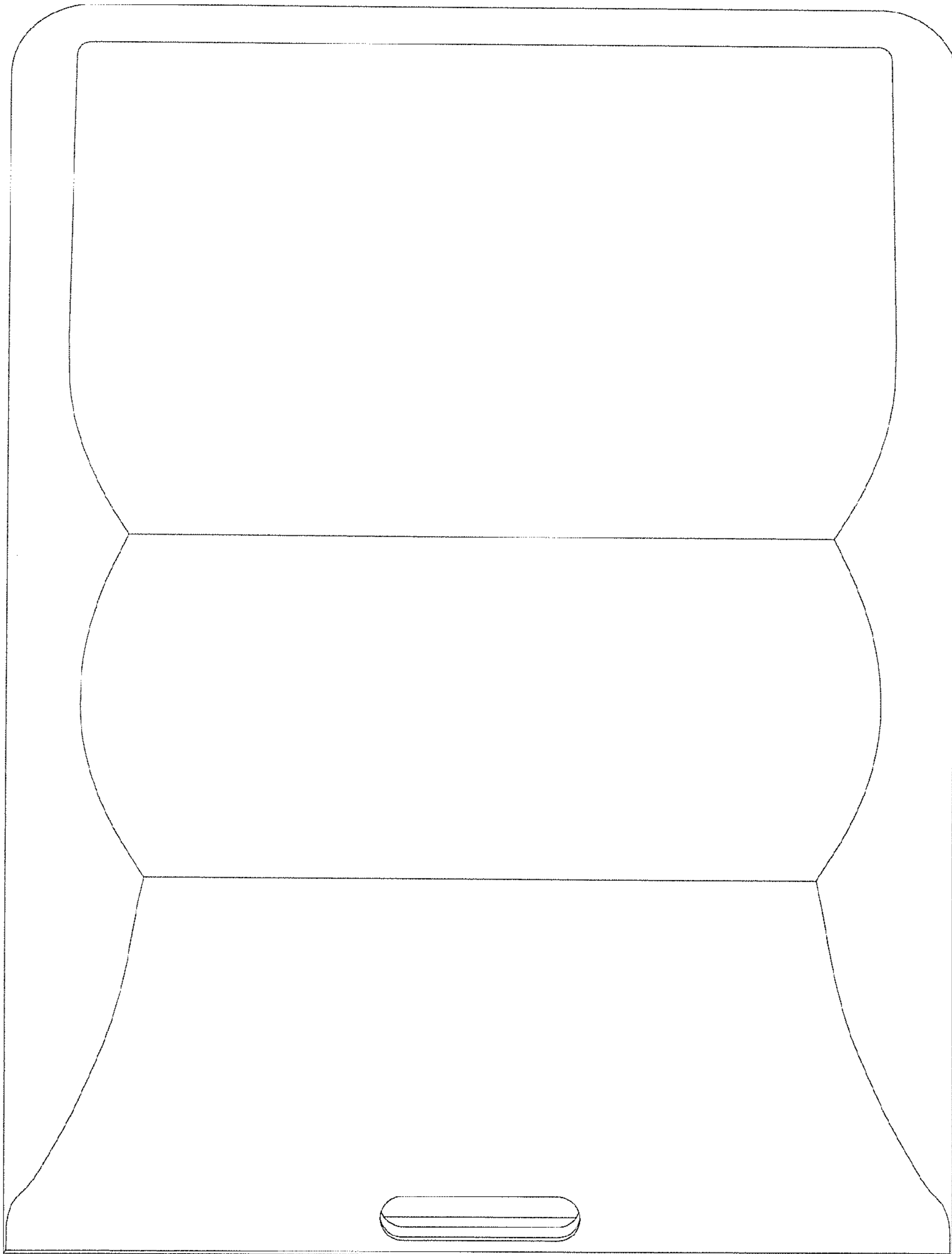
**FIG. 8**

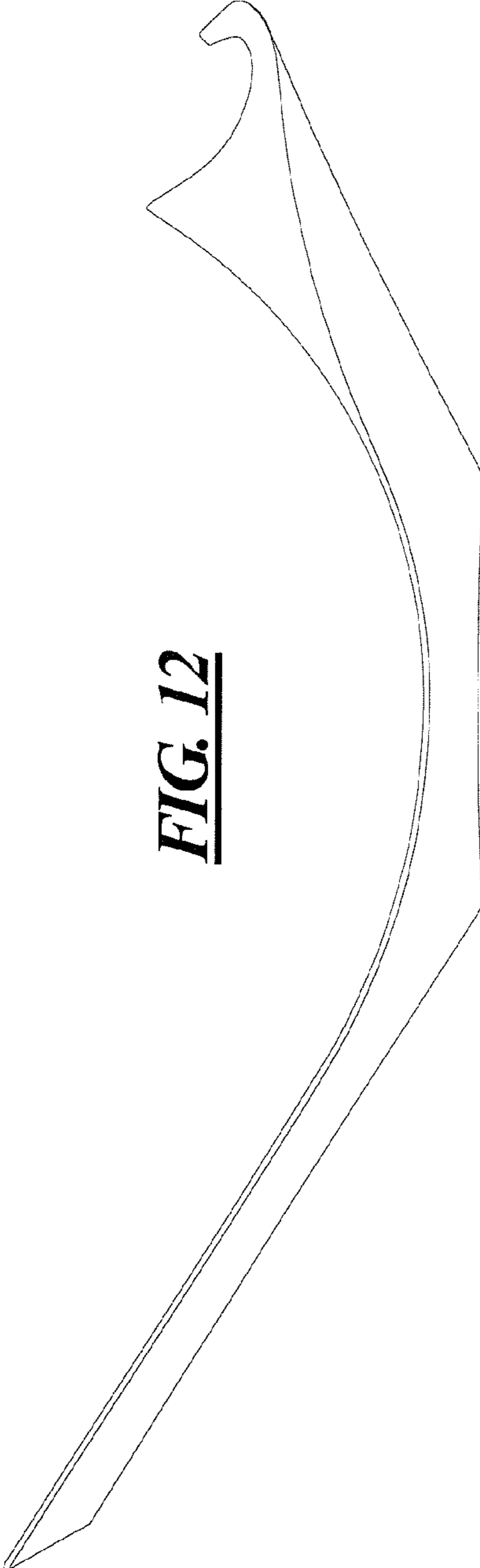
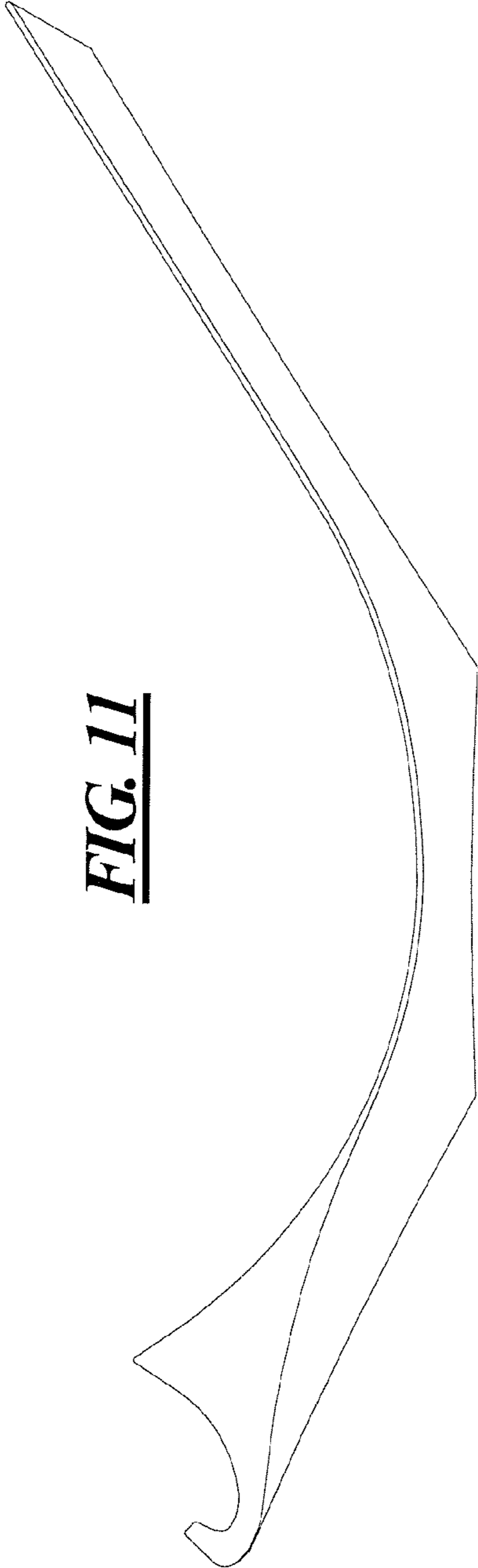


**FIG. 9**

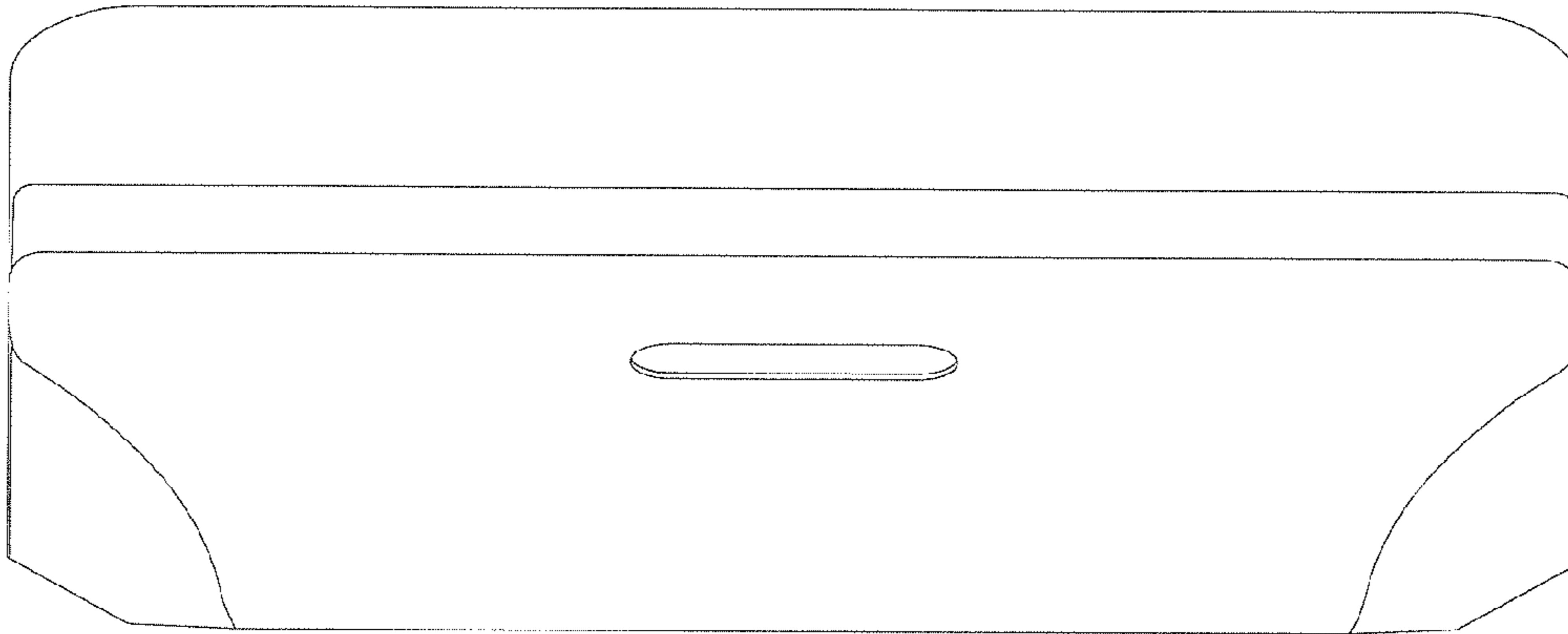


**FIG. 10**





**FIG. 13**



**FIG. 14**

