



US00D715771S

(12) **United States Design Patent**
Funayama

(10) **Patent No.:** **US D715,771 S**
(45) **Date of Patent:** **** Oct. 21, 2014**

(54) **CONTROLLER FOR A DIGITAL AUDIO
PLAYER**

(71) Applicant: **Pioneer Corporation**, Kawasaki (JP)

(72) Inventor: **Tatsufumi Funayama**, Kawasaki (JP)

(73) Assignee: **Pioneer Corporation**, Kawasaki-shi,
Kanagawa (JP)

(**) Term: **14 Years**

(21) Appl. No.: **29/439,858**

(22) Filed: **Dec. 17, 2012**

(30) **Foreign Application Priority Data**

Jul. 9, 2012 (JP) 2012-016177

(51) **LOC (10) Cl.** **14-03**

(52) **U.S. Cl.**
USPC **D14/217**

(58) **Field of Classification Search**

CPC G06F 1/1626; G06F 1/1688; G10H 1/46;
G10H 1/0008; G10H 1/0025; G10H 3/186;
G10H 2210/125; G10H 2240/131; G10H
2240/175; G10H 2250/035; G10L 19/008;
G10L 19/167; G11B 19/02; G11B 20/10527;
G11B 27/00; G11B 27/34; G11B 27/031;
G11B 27/034; G11B 27/038; G11B 27/105;
G11B 33/025; H03G 3/00; H03G 3/04;
H03G 3/3005; H03G 3/3089; H03G 5/00;
H03G 5/005; H03G 5/025; H03G 9/18;
H04B 1/00; H04B 1/034; H04H 3/186;
H04H 60/04; H04H 60/05; H04H 60/91;
H04M 1/03; H04M 1/035; H04R 3/00;
H04R 3/005; H04R 5/04; H04R 2205/01;
H04R 2499/11; H04S 3/02; H04S 3/008;
H04S 7/30; H04S 2400/15; H04S 2420/03;
H04S 2420/07

USPC D14/162, 167, 168, 175, 188, 196-198,
D14/217, 257, 258, 434, 496; 13/163, 164;
84/625, 660, 697; 381/119; 455/350

See application file for complete search history.

(56) **References Cited**

U.S. PATENT DOCUMENTS

D602,914 S * 10/2009 Williamson et al. D14/217
D615,993 S * 5/2010 Ho D14/496

(Continued)

FOREIGN PATENT DOCUMENTS

JP 1333697 S 6/2008
JP 1413839 S 5/2011

(Continued)

OTHER PUBLICATIONS

Pioneer Sound.Vision.Soul, Professional Dj Series, "More Scratch,
Hard Scratch," 2003, <http://www.pioneer.co.jp/cdj/>.

Primary Examiner — Keli L Hill

(74) *Attorney, Agent, or Firm* — Drinker Biddle & Reath
LLP

(57) **CLAIM**

The ornamental design for controller for a digital audio
player, as shown and described.

DESCRIPTION

FIG. 1 is a perspective view of the front, bottom and right side
of controller for a digital audio player showing my new
design;

FIG. 2 is a front view thereof;

FIG. 3 is a rear view thereof,

FIG. 4 is a top view thereof,

FIG. 5 is a bottom view thereof,

FIG. 6 is a left side view thereof;

FIG. 7 is a right side view thereof;

FIG. 8 is a perspective view in a state that a handle is equipped
thereof; and,

FIG. 9 is a perspective view in a state that the handle and
monitor are equipped thereof.

The broken lines showing of controller for a digital audio
player is included for the purpose of illustrating portions of
controller for a digital audio player and forms no part of the
claimed design.

1 Claim, 4 Drawing Sheets

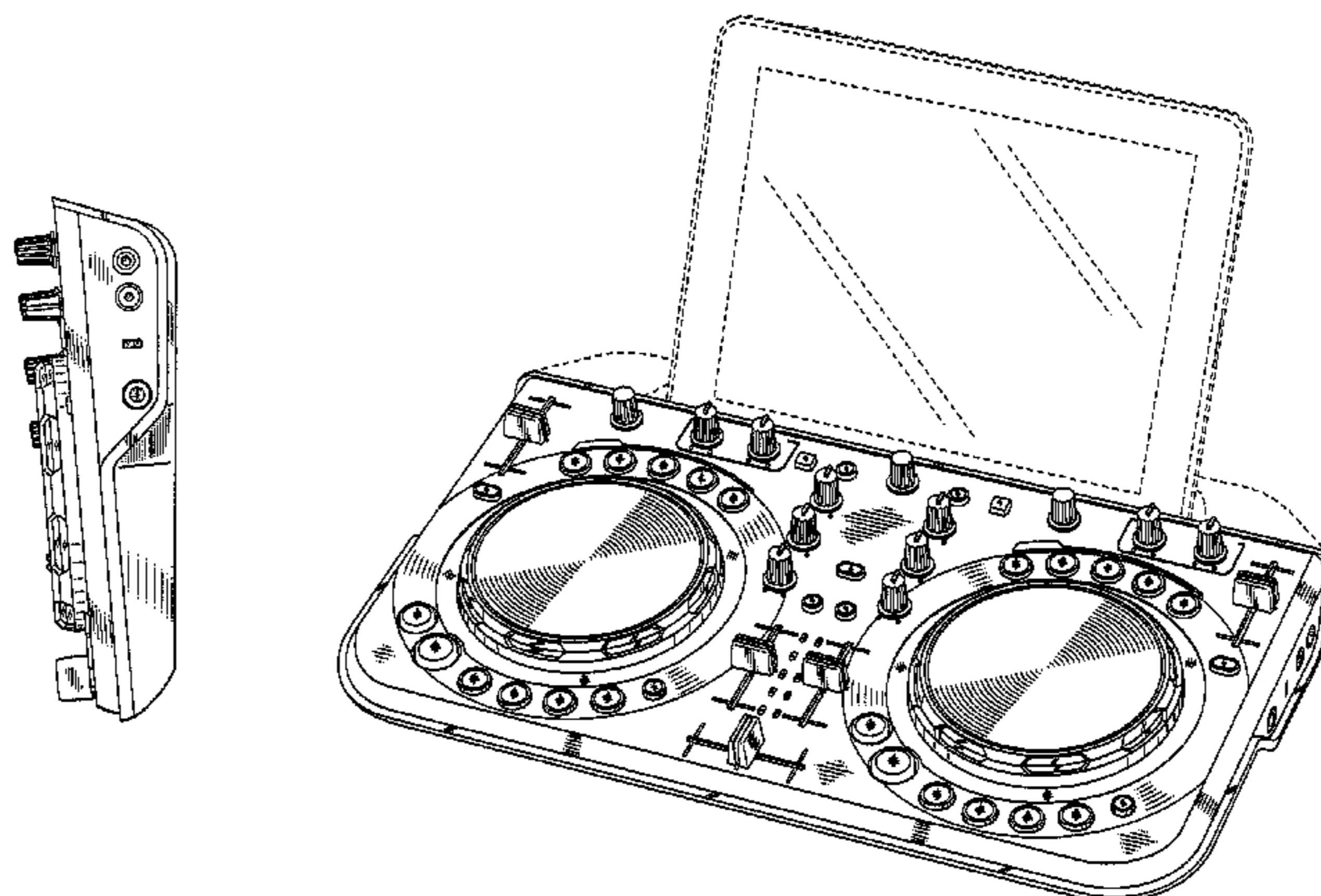

(56)

References Cited

U.S. PATENT DOCUMENTS

D624,053 S * 9/2010 Williamson et al. D14/217
D641,733 S * 7/2011 Jenkins D14/217
D648,324 S * 11/2011 Medas D14/217
D665,778 S * 8/2012 Langlois D14/217
D666,172 S * 8/2012 Iijima et al. D14/217
D666,173 S * 8/2012 Iijima et al. D14/217
D678,249 S * 3/2013 Kuramoto D14/217

D678,250 S * 3/2013 O'Donnell et al. D14/217
D687,019 S * 7/2013 O'Donnell et al. D14/217
D689,486 S * 9/2013 O'Donnell et al. D14/388
2013/0123961 A1* 5/2013 Roman et al. 700/94

FOREIGN PATENT DOCUMENTS

JP 1414161 S 5/2011
JP 1435768 S 3/2012

* cited by examiner

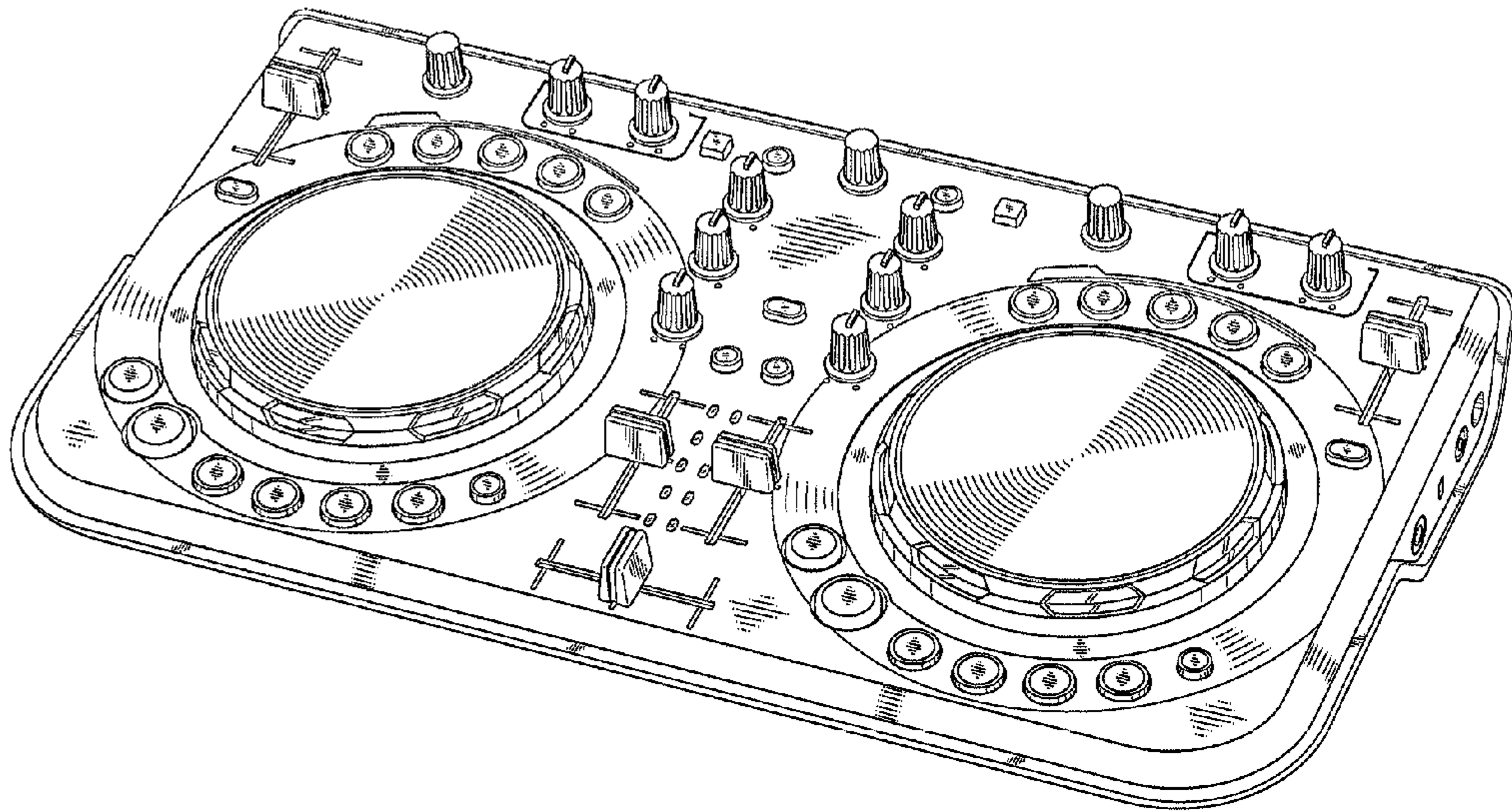

FIG. 1

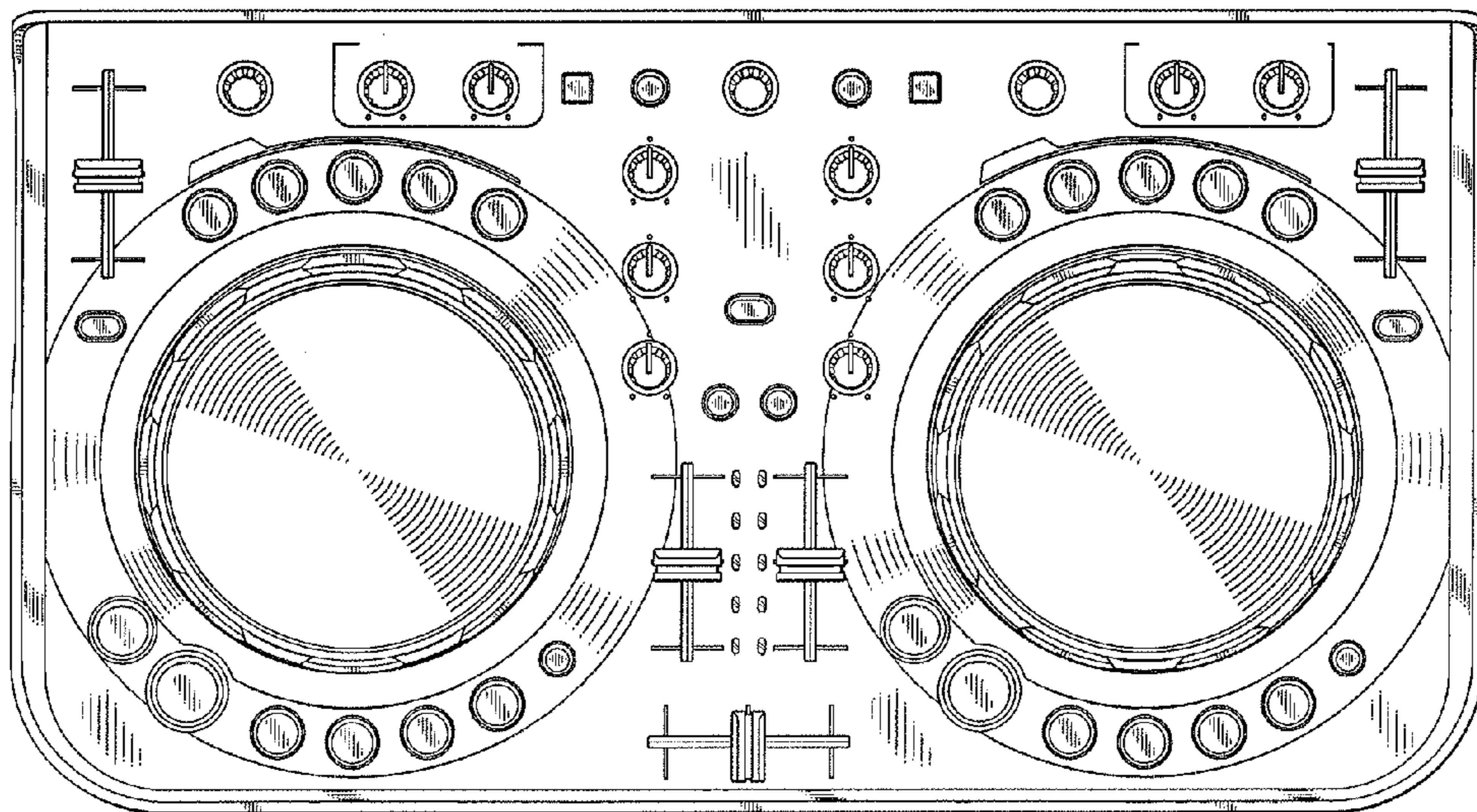

FIG. 2

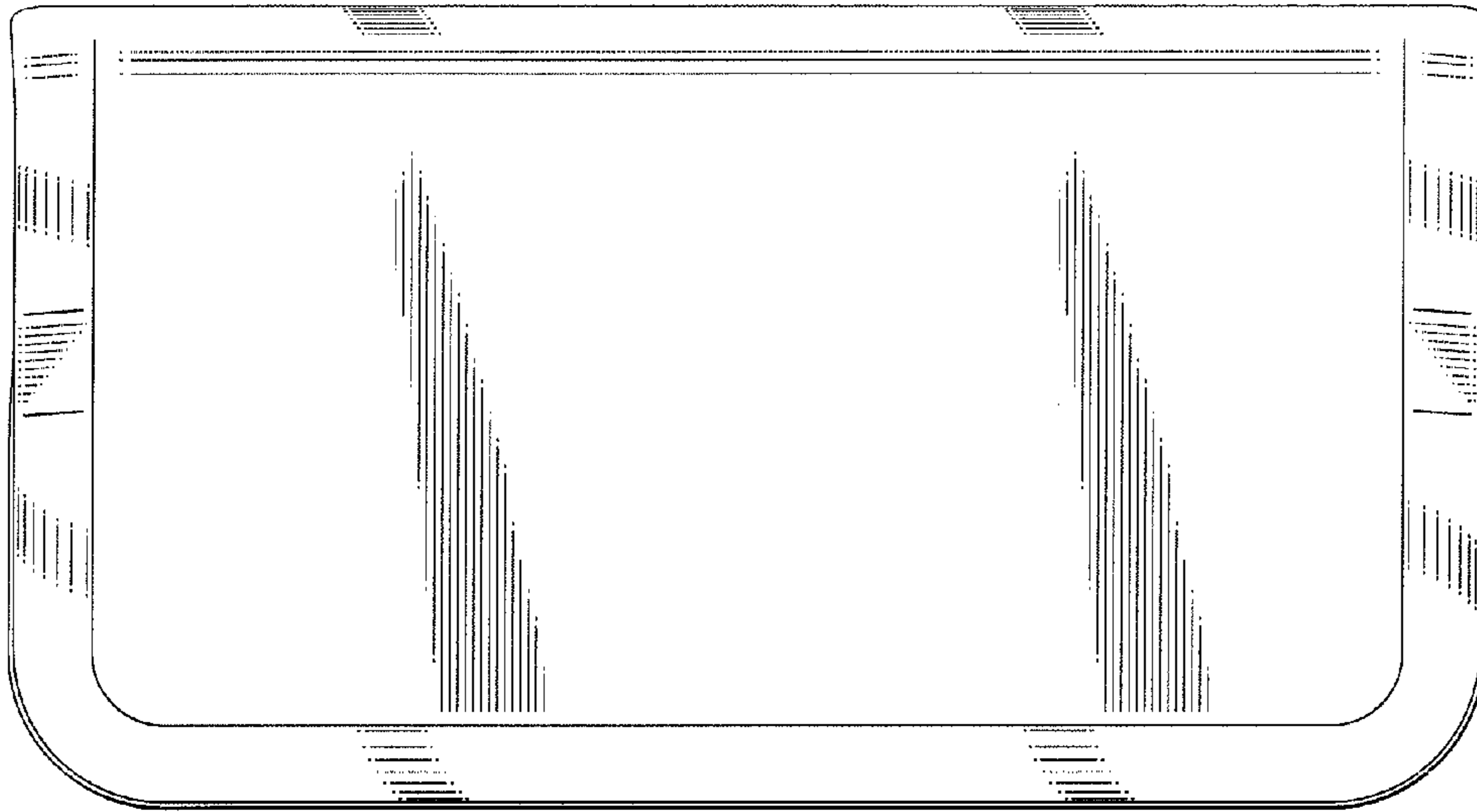

FIG. 3

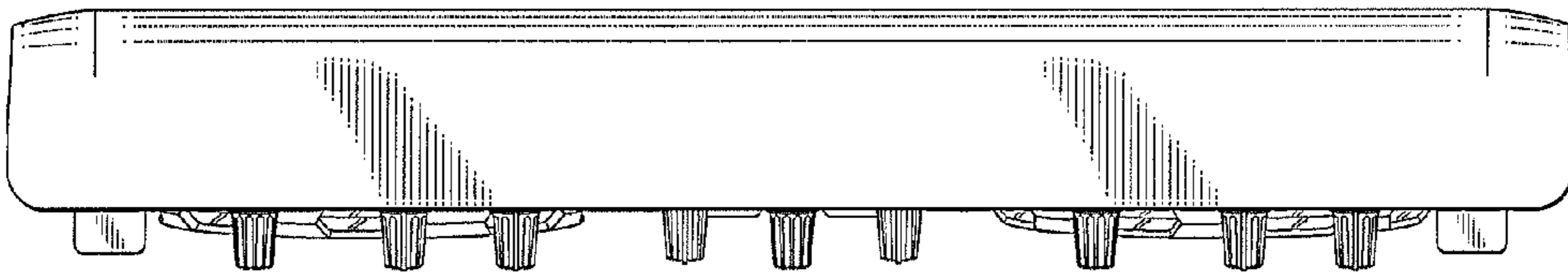

FIG. 4

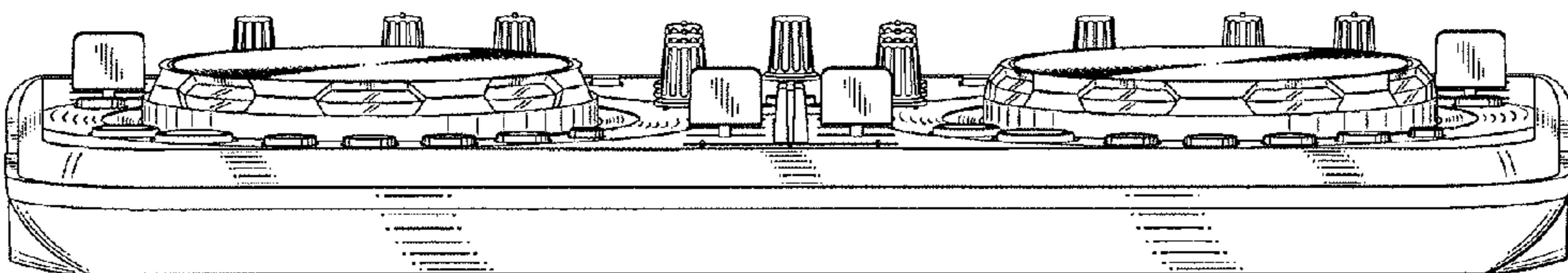

FIG. 5

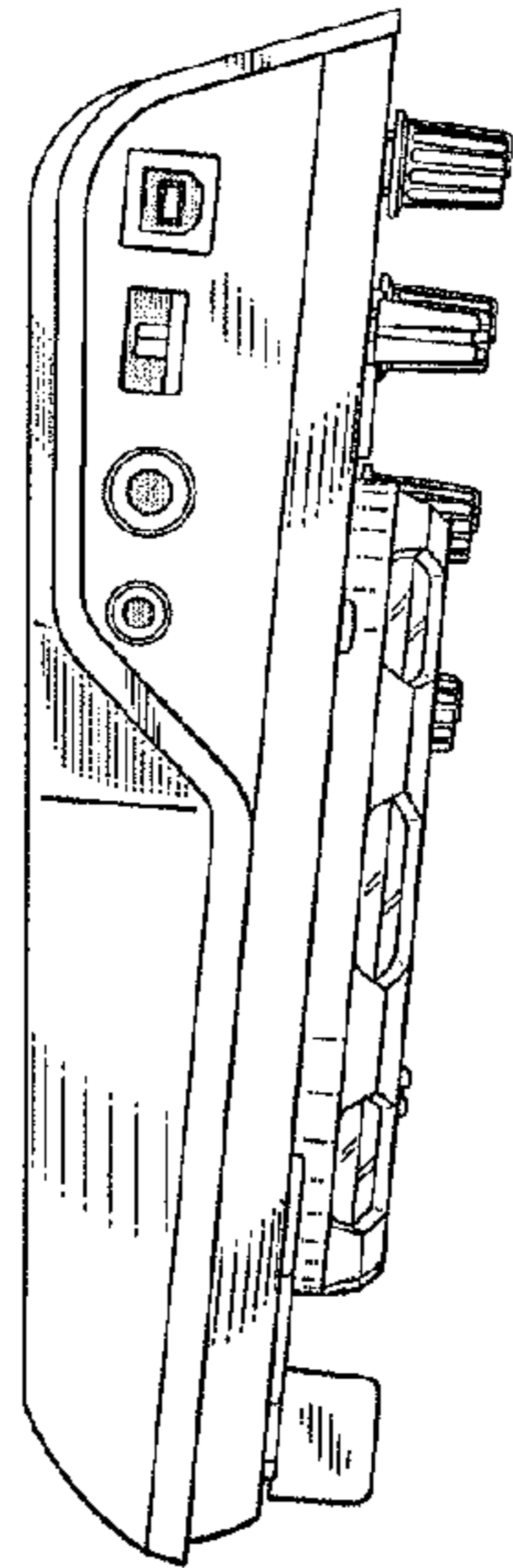

FIG. 6

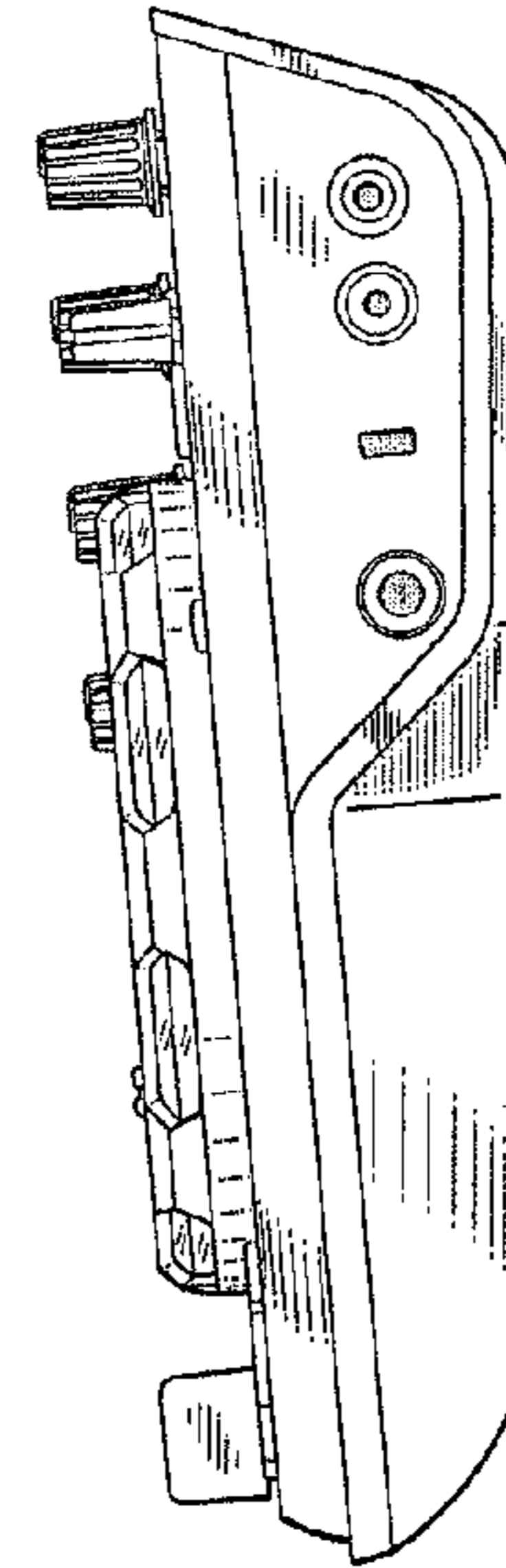

FIG. 7

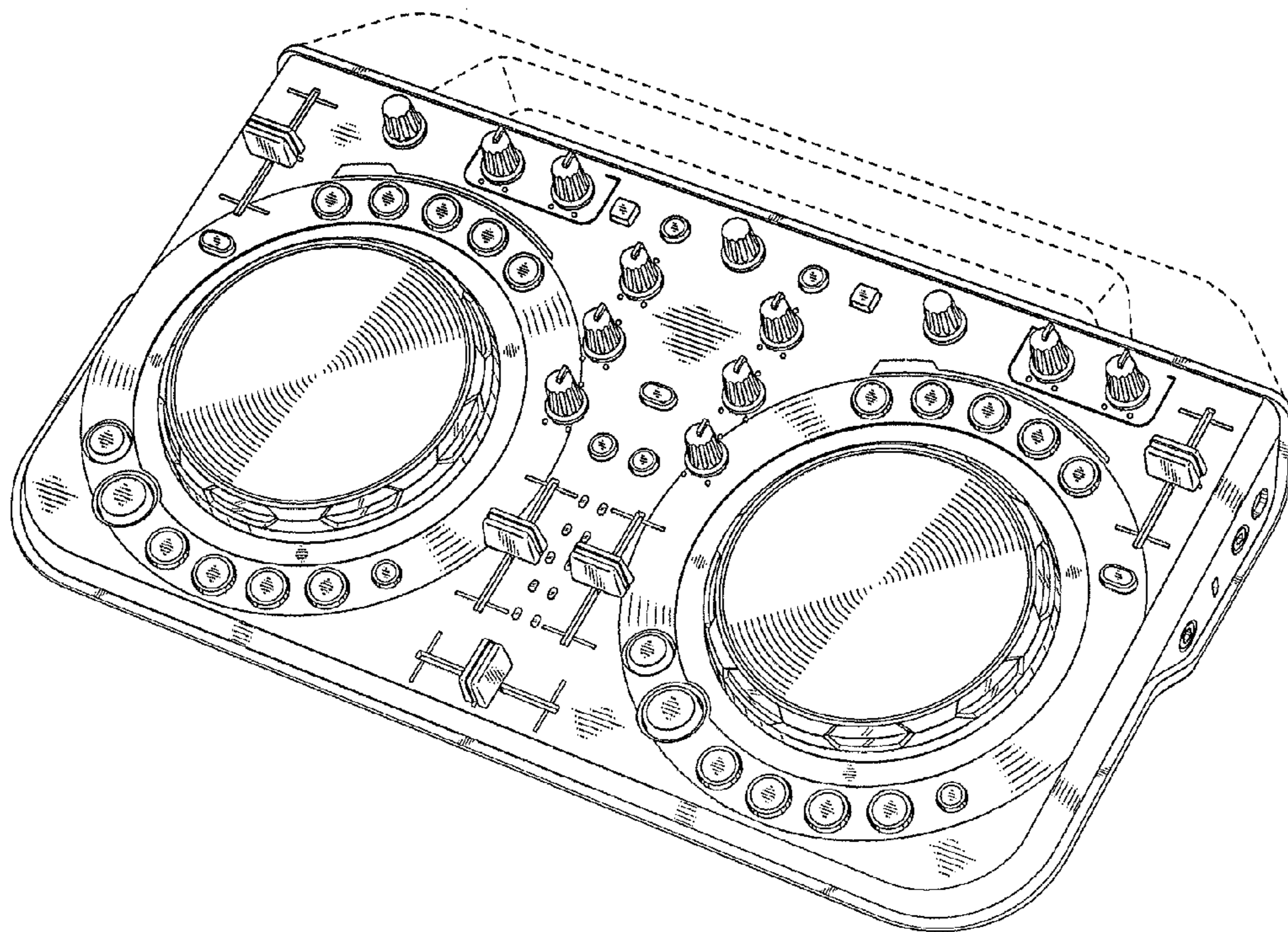

FIG. 8

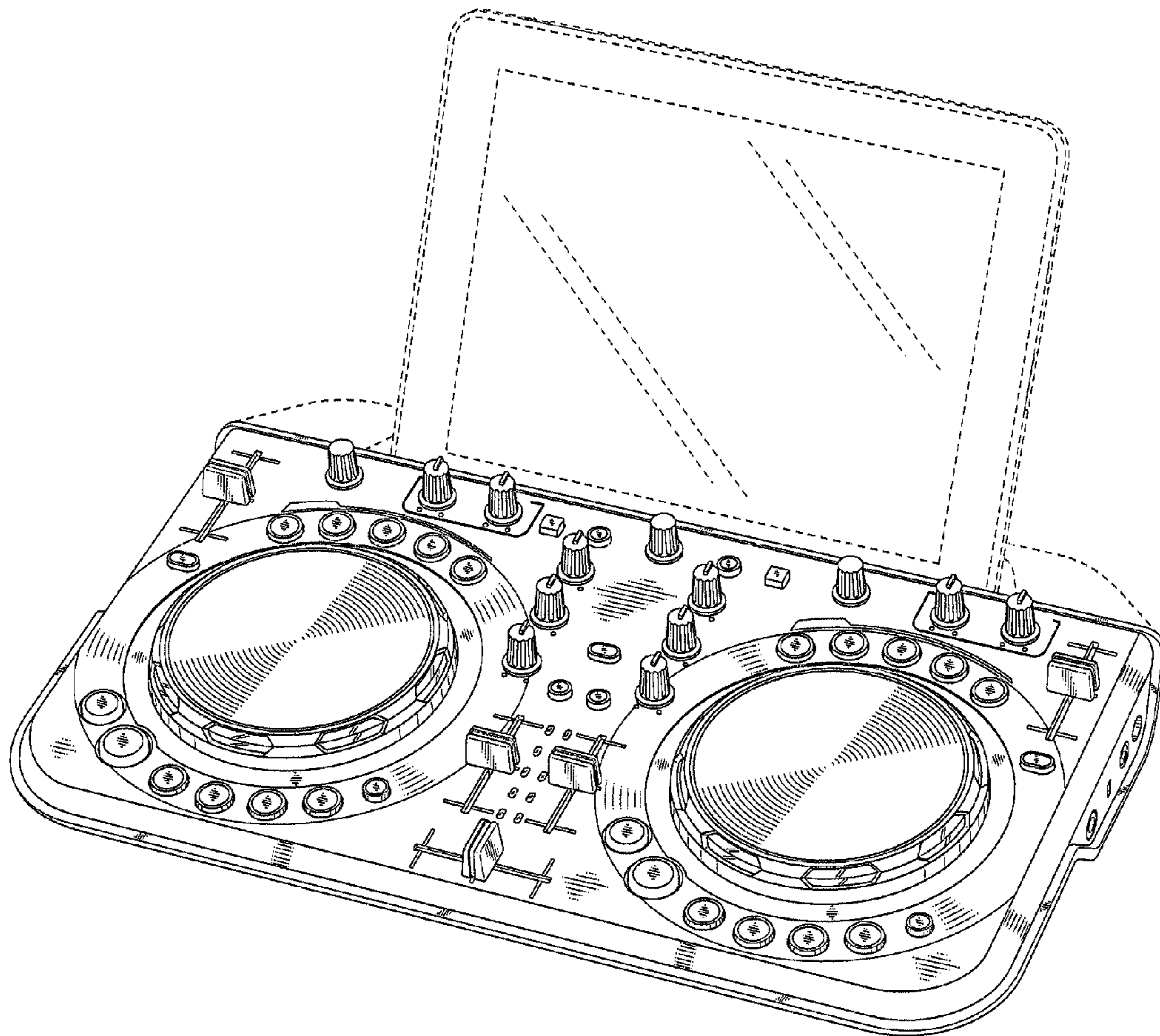

FIG. 9